



Greenhouse Style  
CORPORATION

# Installation & Assembly Manual

Freestanding & Straight-Eave Models

Toll Free: 1-800-665-2124 | Fax: 1-888-273-1251

[www.greenhousetyle.com](http://www.greenhousetyle.com)





Watch for the "Pro Tips" throughout the Manual for Tips & Tricks that our Professional Installers have picked up throughout the years.

#### DISCLAIMER

This Instruction Manual is meant to be generic and cover as many facets of the Greenhouse Installation as possible. Oddities or Customizations may not be covered in this Manual but will be detailed in the Job-Specific Drawings that are shipped with the Greenhouse.

### ***This Instruction Manual may appear daunting but please don't panic.***

While the frame assembly process of each greenhouse is virtually identical regardless of the glazing type, each glazing process is slightly different and they are all covered in this Manual. Refer only to the sections that apply to the greenhouse you are assembling and disregard the ones that don't.

#### COMMON ABBREVIATIONS YOU MAY SEE IN YOUR JOB-SPECIFIC DRAWINGS

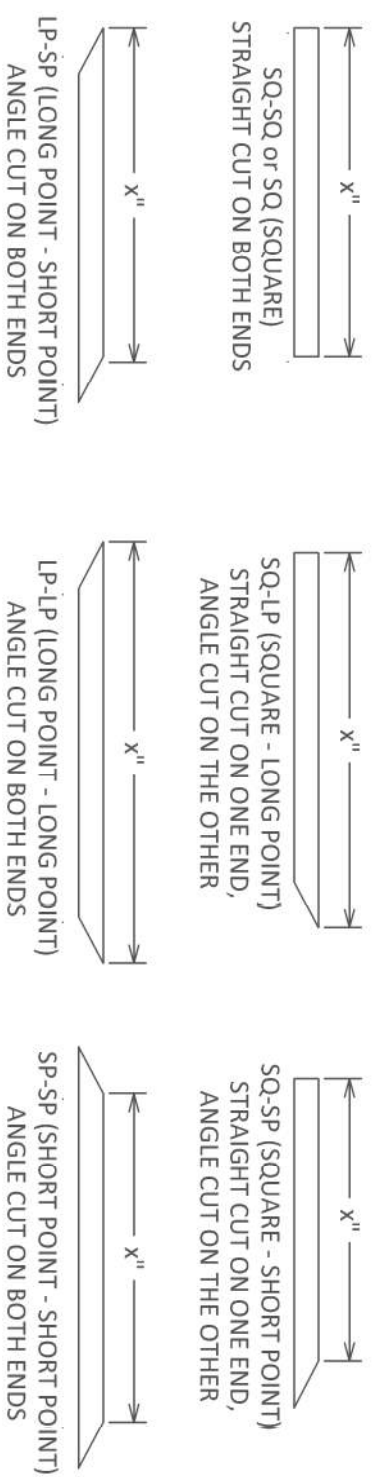

#### TECHNICAL SUPPORT

BC Greenhouse Builders is located in Surrey British Columbia, Canada.

If your Dealer or Salesperson is unable to assist you, feel free to contact us directly.

Monday to Friday, 9am to 5pm Pacific Time.

Local (604)-882-8408 or Toll Free 1-888-391-4433

email: techsupport@bcgreenhouses.com

*If calling after business hours, leave a message with our answering service and somebody will get back to you as soon as we are able.*

## REQUIRED TOOLS

(not included with greenhouse kit)

#### EVERY GREENHOUSE (HOBBY OR COMMERCIAL)

- TAPE MEASURE
- LEVEL (min. 4')
- SET SQUARE
- #2 ROBERTSON (SQUARE) SCREW DRIVER
- #2 ROBERTSON (SQUARE) DRIVER BIT
- UTILITY KNIFE
- CORDLESS DRILL
- CAULKING GUN
- LATEX GLOVES or CAULK-SMOOTHING TOOL
- STEP LADDER (2)
- $\frac{7}{16}$ " NUT DRIVER
- $\frac{7}{16}$ " OPEN-ENDED WRENCH
- $\frac{1}{4}$ " CONCRETE DRILL BIT (if applicable)
- LIGHT SOAPY WATER (in a spray-bottle)
- LARGE FLAT BLADED SCREW DRIVER (Storefront Door)
- 3MM ALLEN KEY (Storefront Door)

#### GREENHOUSES OVER: 14' IN LENGTH or WIDTH (COMMERCIAL)

- $\frac{3}{8}$ " WOOD DRILL BIT (wood foundation)
- $\frac{1}{2}$ " WOOD DRILL BIT (wood foundation)
- $\frac{7}{16}$ " CONCRETE DRILL BIT (concrete foundation)
- $\frac{9}{16}$ " CONCRETE DRILL BIT (concrete foundation)
- $\frac{1}{16}$ " SOCKET
- $\frac{9}{16}$ " OPEN ENDED WRENCH
- $\frac{3}{4}$ " SOCKET
- HAMMER

#### OPTIONAL TOOLS

- SUCTION CUPS (6mm Single Glass & 16mm Double Glass Models)
- SCAFFOLDING

#### NOT RECOMMENDED TOOLS

- IMPACT WRENCH / DRIVER

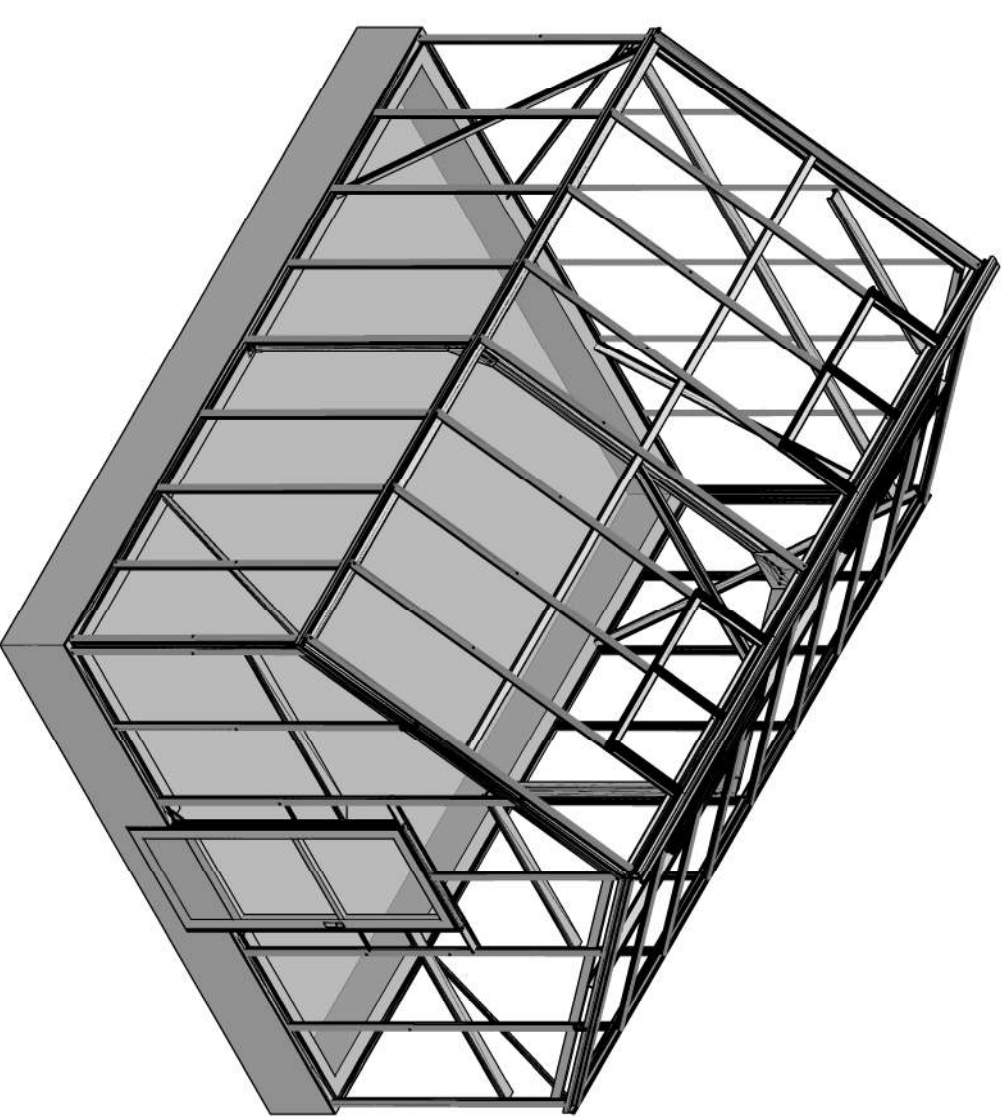



**PRO TIPS**



The Rough Opening in your foundation is different than the Door Opening between your bases. (Between 1/4" & 1/2" depending on the door size)

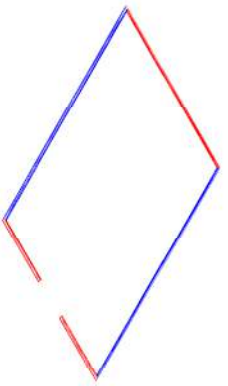

**STAGE 1: BASES**

**\*WARNING\***  
**-FOUNDATION MUST BE LEVEL -**  
 An off-level foundation will make glazing the greenhouse difficult (or impossible) later on in the installation process.  
 There is a small level of tolerance built into the greenhouse (approximately 1/4")

*If your greenhouse has Side Vents, refer to Page ACC134 (Side Vent Installation) at the rear of the manual before beginning the frame assembly.*

- STEPS:**
1. APPLY A BEAD OF CAULKING TO UNDERSIDE OF FRONT BASE FOR ENTIRE LENGTH OF BASE.
  2. PLACE FRONT BASE ON FOUNDATION. **ENSURE DOOR OPENING IS CORRECT<sup>n</sup>.**
  3. FASTEN FRONT BASE TO FOUNDATION WITH 1 3/4" #10 S.S. SCREW<sup>o</sup>.
  4. SEAL HEAD OF SCREW WITH CAULKING.
  5. REPEAT STEPS 1 to 4 FOR SIDE BASES & BACK BASES
  6. APPLY CAULKING TO SEAM WHERE BASES BUTT TOGETHER.
  7. TOOL CAULKING WITH A SOAPY GLOVED FINGER OR A CAULK-SMOOTHING TOOL.

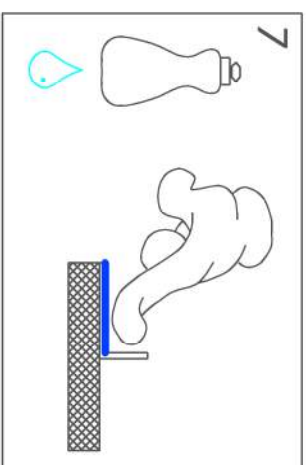
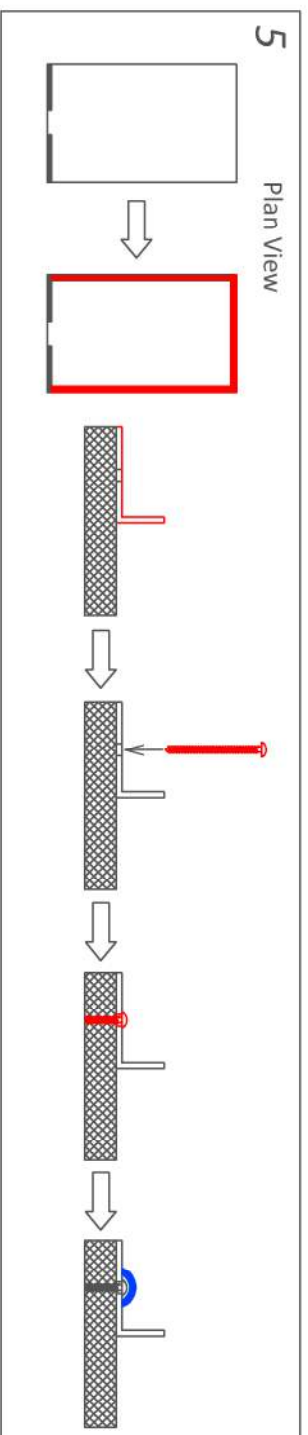
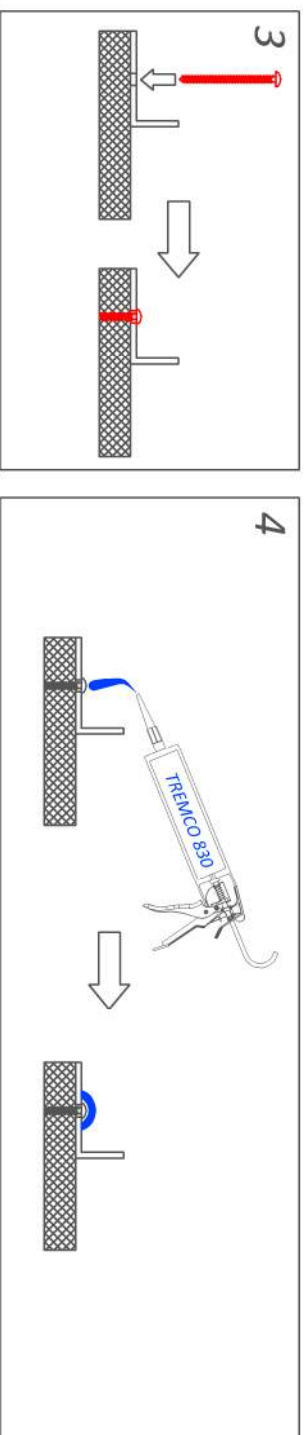
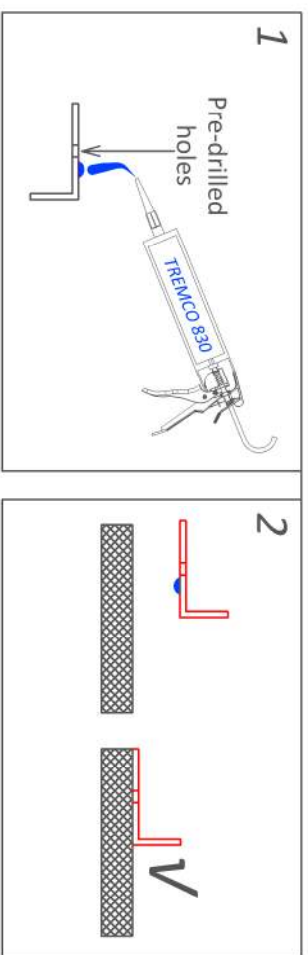

Base Screw with Concrete Plug

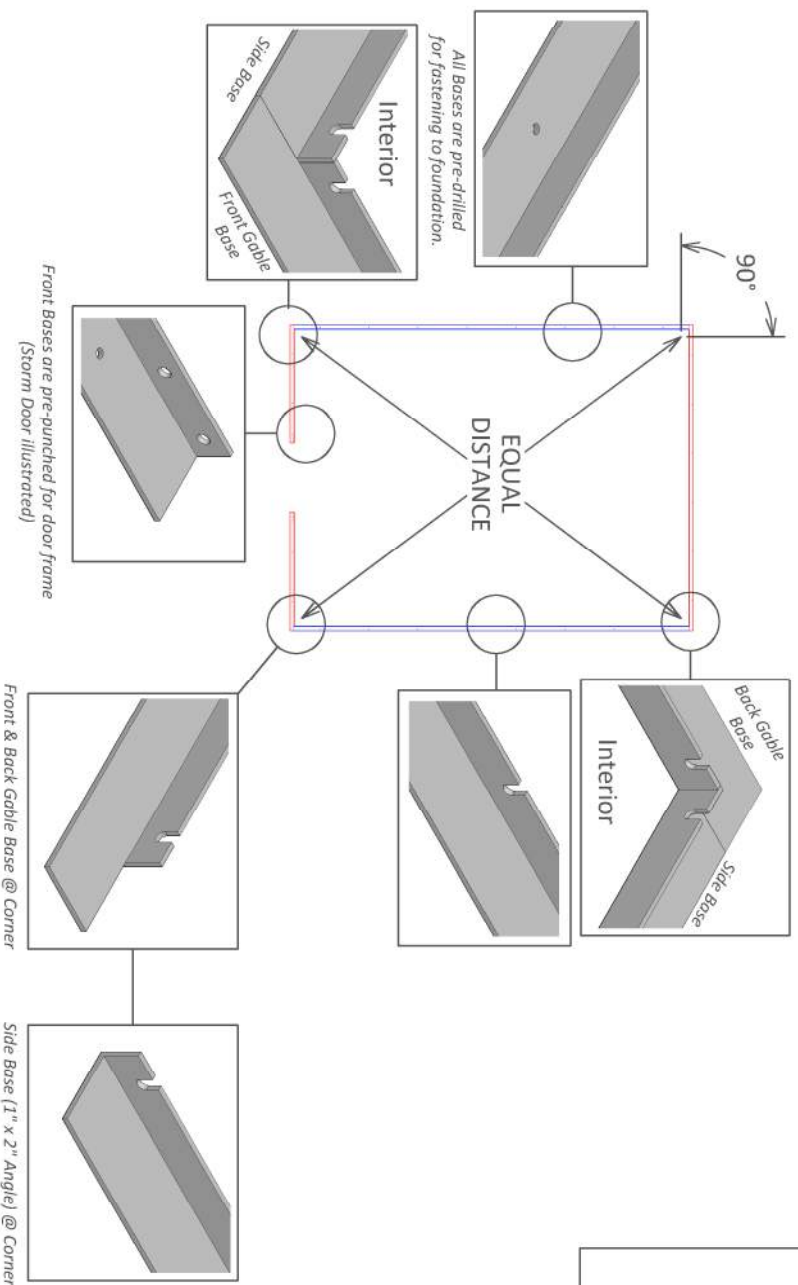

Front Bases are pre-punched for door frame (Storm Door illustrated)

Front & Back Gable Base @ Corner

Side Base (1" x 2" Angle) @ Corner

**Parts List:**

- Front Gable Base (1" x 2" Angle) ALL Glazing Types
- Back Gable Base (1" x 2" Angle) ALL Glazing Types
- Side Base (1" x 2" Angle) ALL Glazing Types
- #10 x 1 3/4" S.S. Screw
- Concrete Plug (if applicable)
- TREMCO 830
- Caulking

<sup>n</sup> Refer to the job-specific drawings provided for your precise door opening.  
<sup>o</sup> For concrete foundations, drill through the pre-punched holes in the base using a 3/8" concrete bit.  
<sup>o</sup> Lightly twist concrete plugs onto the end of the 1 3/4" screw before inserting into hole and tightening screw.

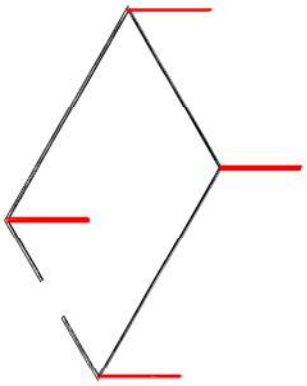

**STAGE 2: CORNER POSTS**

- STEPS:**
1. APPLY FOAM TAPE TO PRE-ATTACHED GLAZING BARS.
  2. PLACE CORNER POST ON TOP OF BASE AT ONE CORNER.
  3. CONNECT CORNER POST TO BASES.

REPEAT FOR ALL CORNERS.

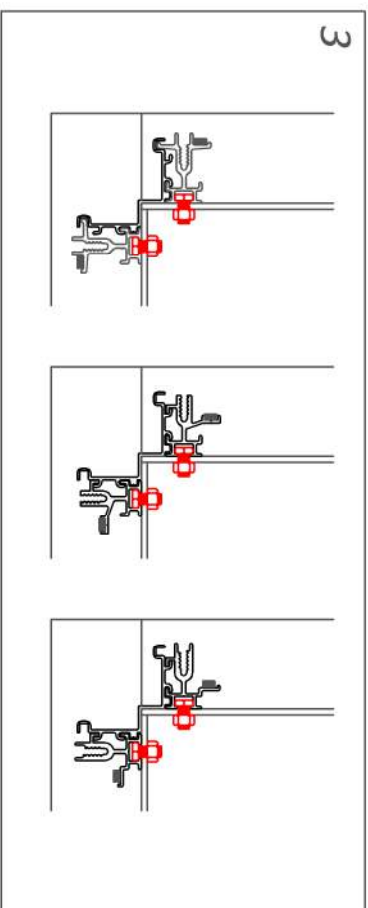
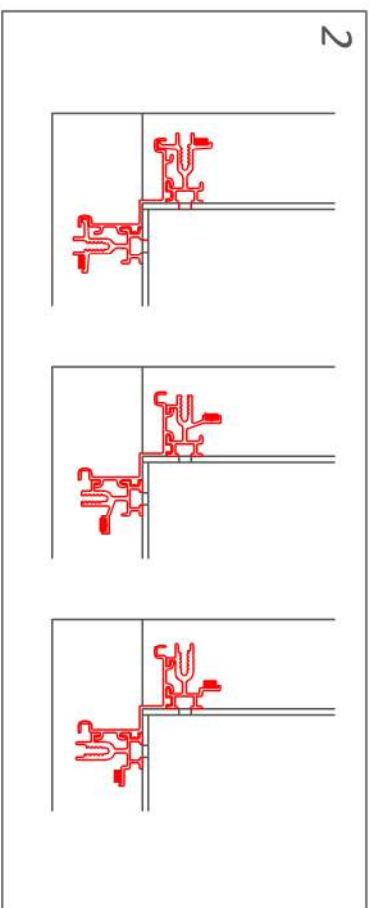
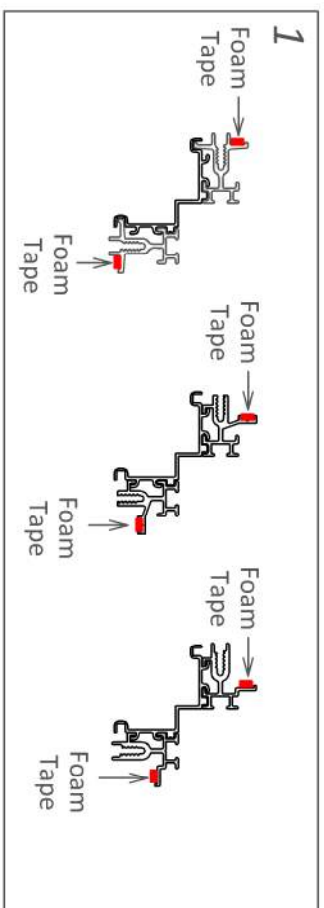
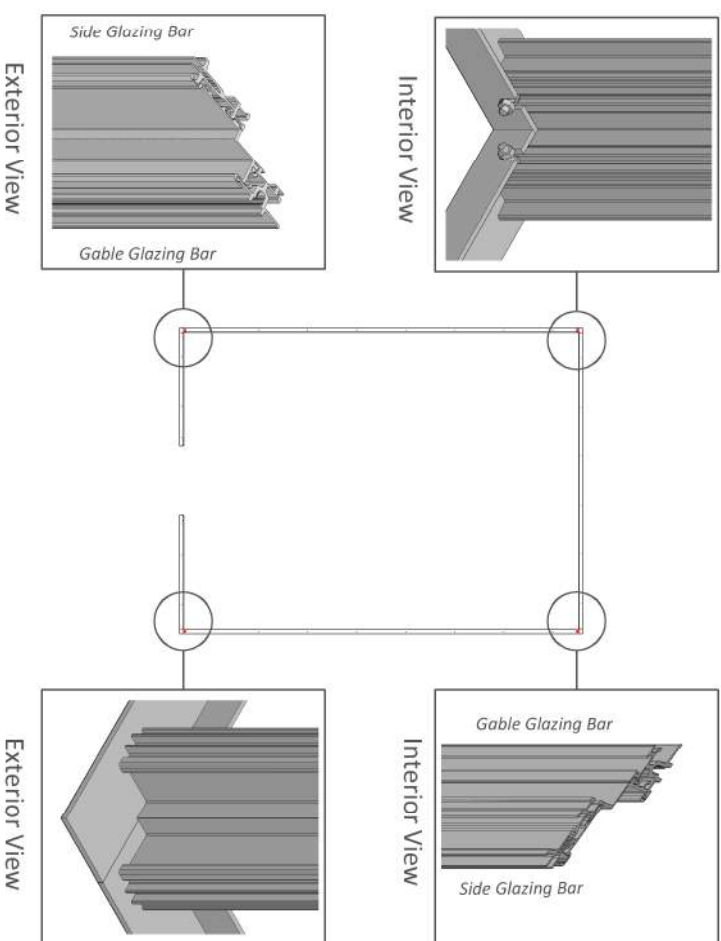

**PRO TIPS**

Apply Foam Tape to all Glazing Bars in advance to save yourself time during installation. (Just make sure you don't mix up your pieces)

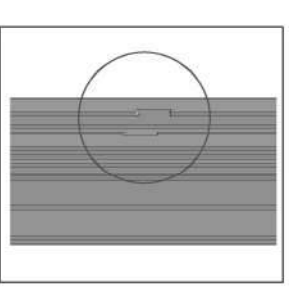
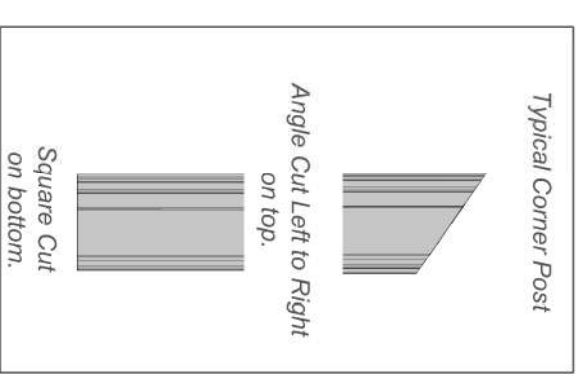

ALL GLAZING BARS ARE NOTCHED FOR INSERTING BOLT HEADS

**Parts List:**

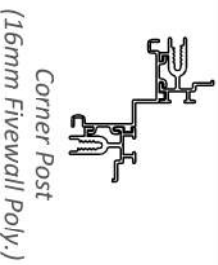
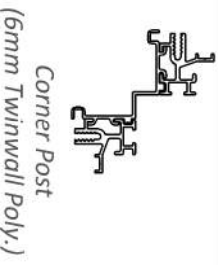

$\frac{1}{4}$ " x  $\frac{1}{2}$ " S.S. Bolt & Nut



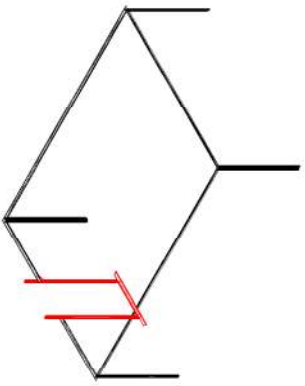

**STAGE 3A: DOOR FRAME**

**STEPS:**  
*If installing a Storefront Door, refer to Page #ACC 12A in the Accessory section of this manual.*

1. CONNECT TOP DOOR PLATES TO 1" X 2" ANGLE HEADER.
2. CONNECT SHORT DOOR FRAME BAR TO HEADER & TOP DOOR PLATE.
3. CONNECT BOTTOM DOOR PLATES TO BASE.

TURN TO NEXT PAGE.

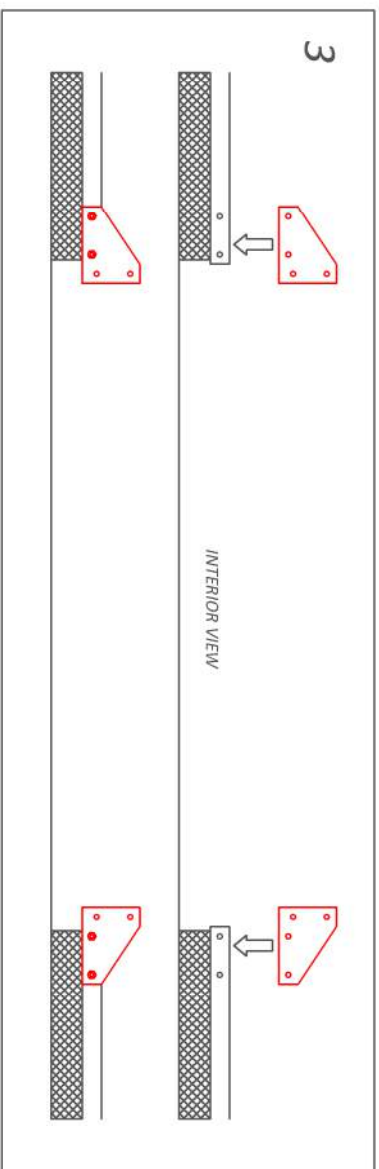
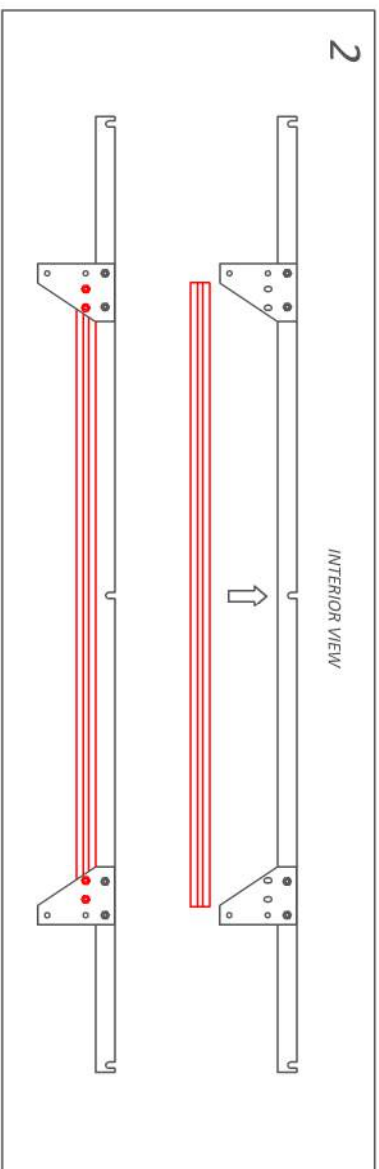
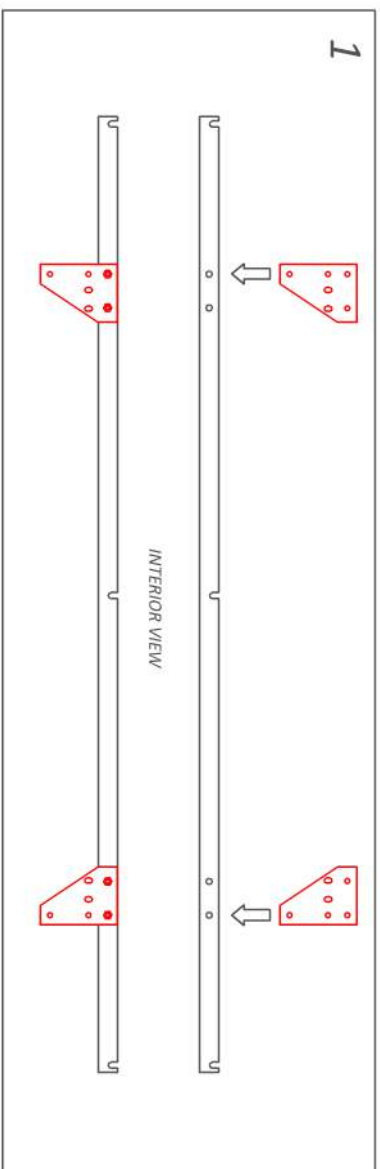
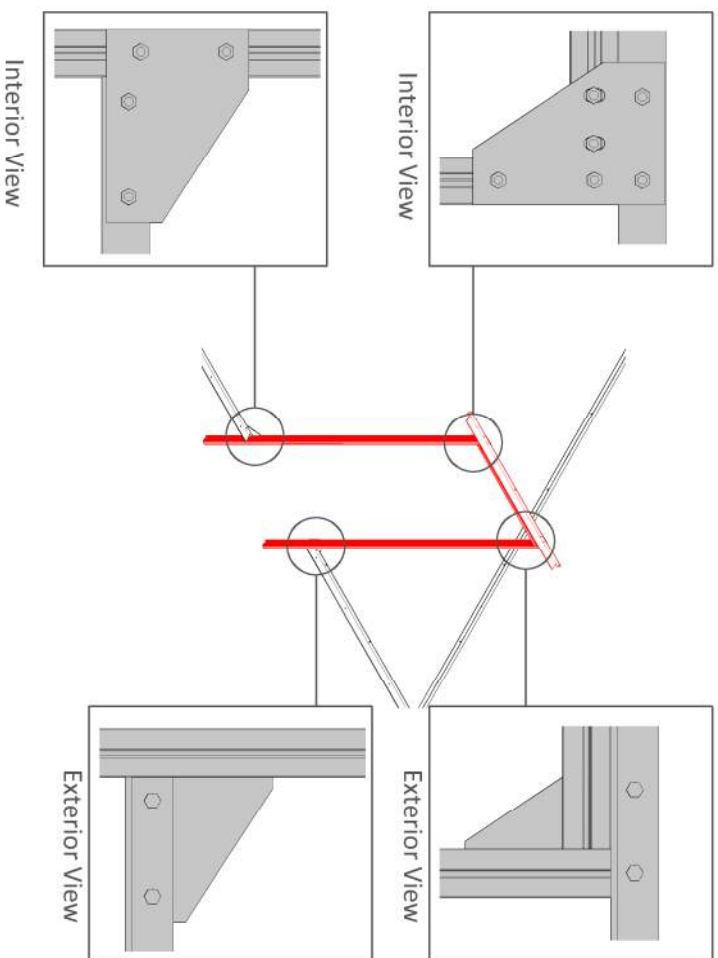

\* DOOR FRAME PACKAGES ON 16MM DOUBLE GLASS & SMALL POLYCARBONATE GREENHOUSES WILL CONTAIN (2) LONG H-CHANNELS. RETAIN THESE FOR GLAZING LATER ON IN THE INSTALLATION PROCESS.

DOOR FRAME BARS ARE NOTCHED FOR INSERTING BOLT HEADS

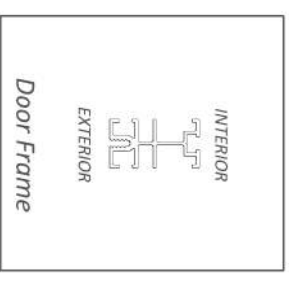
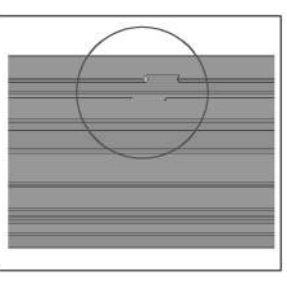

**Parts List:**

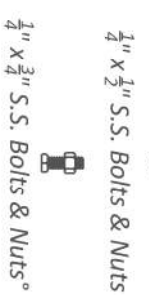
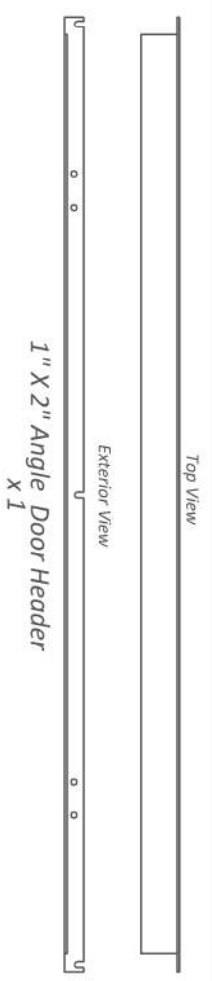
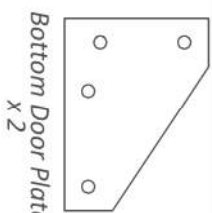
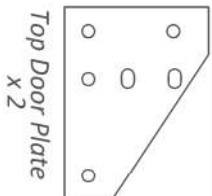
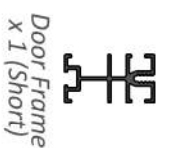
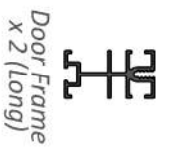

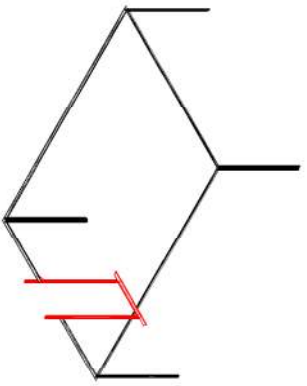

**STAGE 3B: DOOR FRAME**

- STEPS:**
- CONNECT LONG DOOR FRAME BARS TO BOTTOM DOOR PLATES & SET TO APPROPRIATE DOOR DROP.\*
  - CONNECT HEADER ASSEMBLY TO LONG DOOR FRAME BARS.

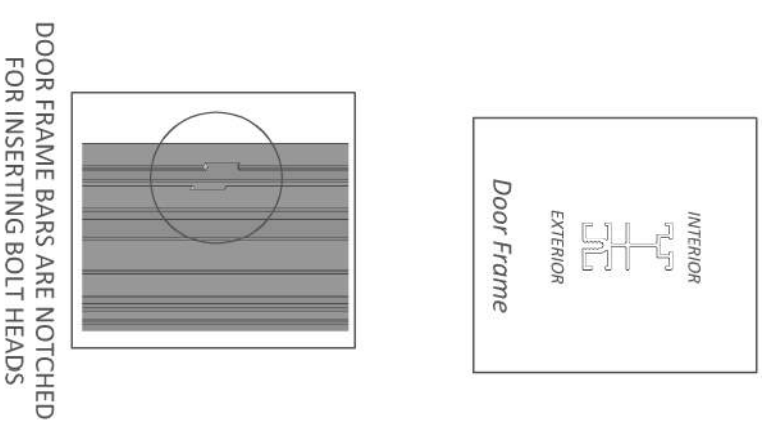
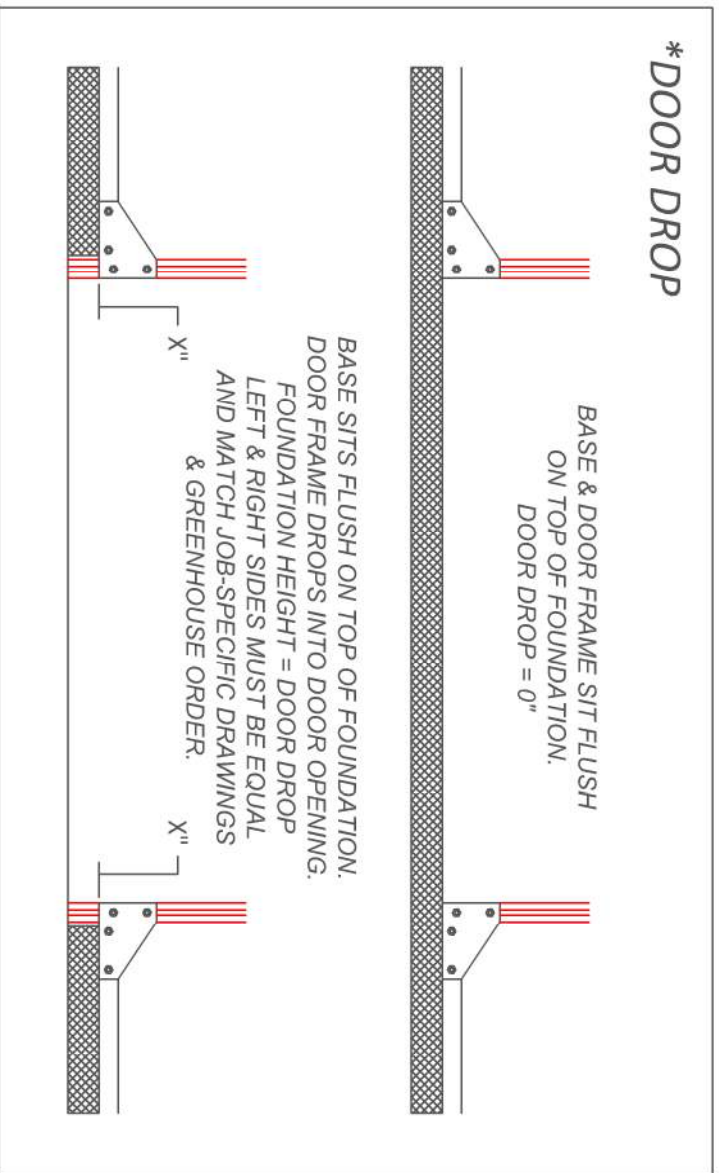
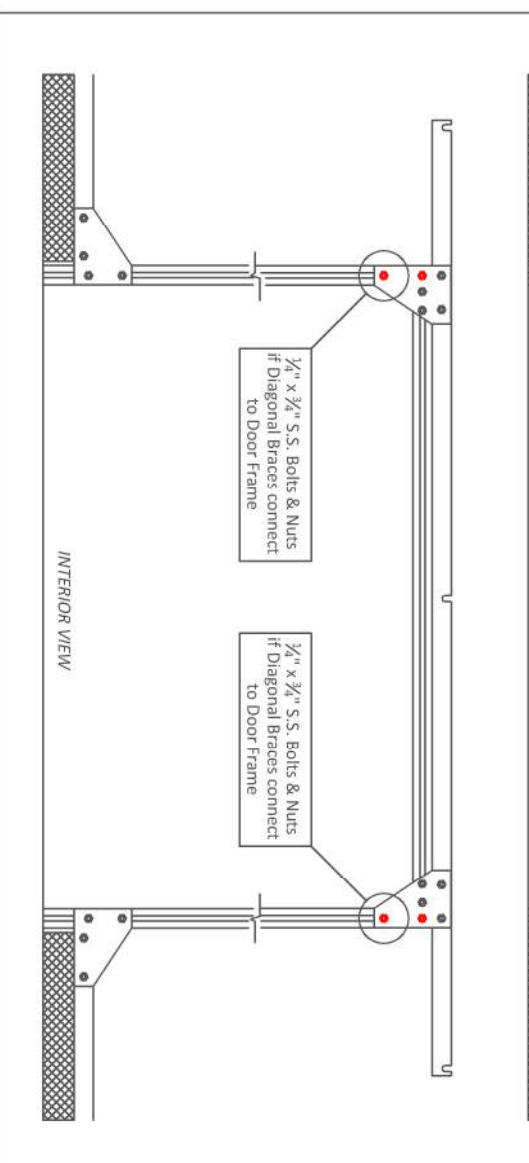
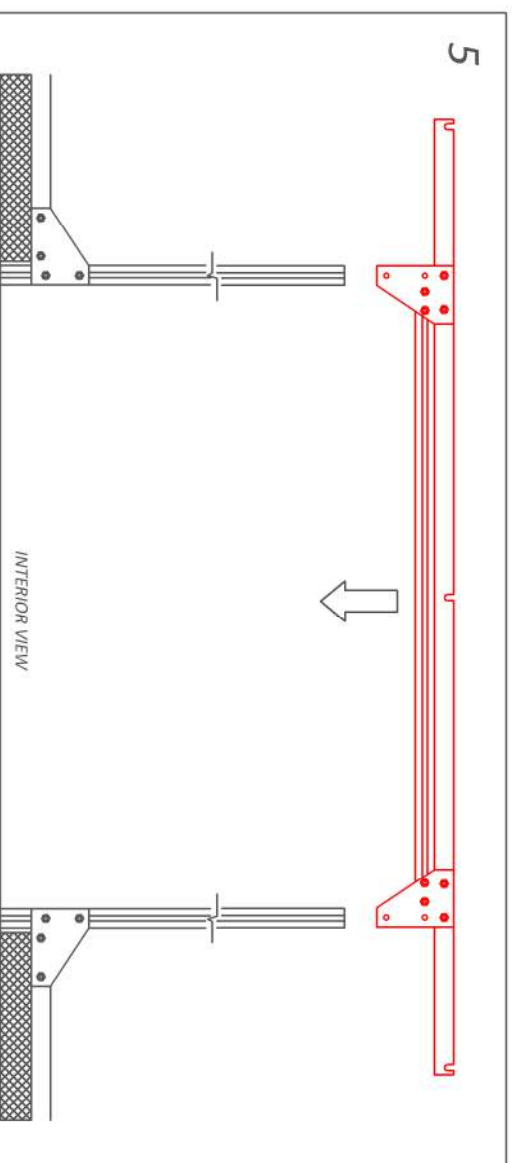
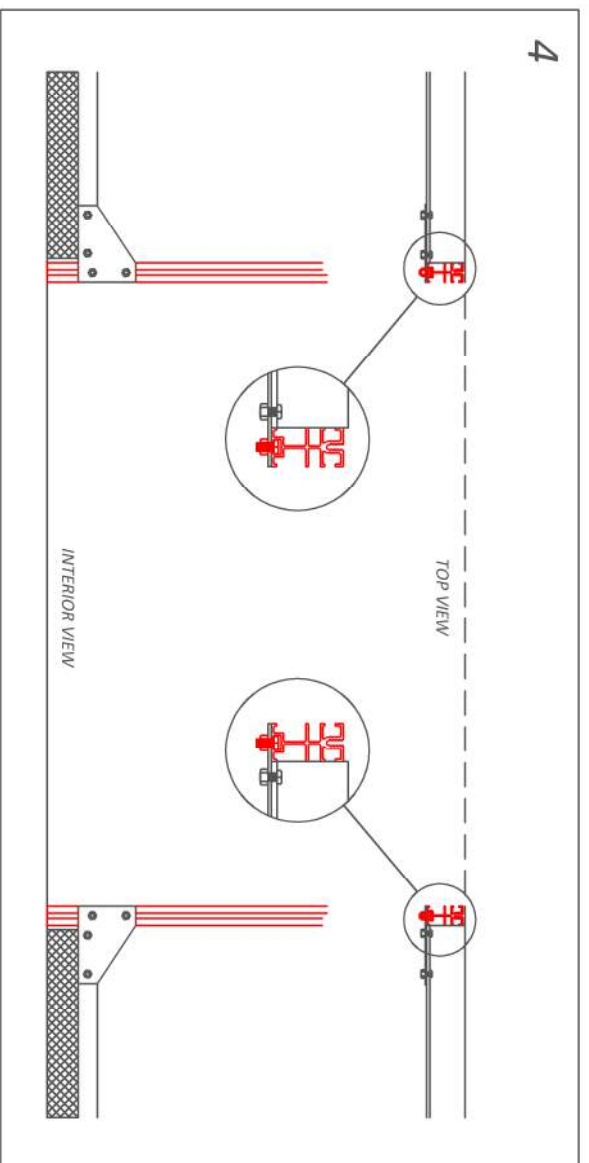

**Parts List:**

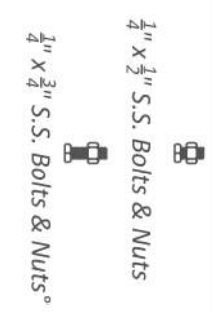
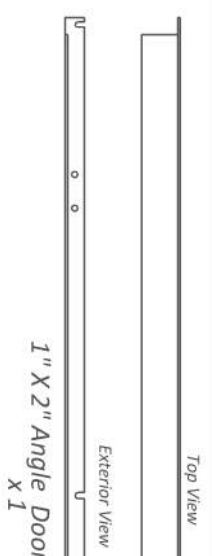
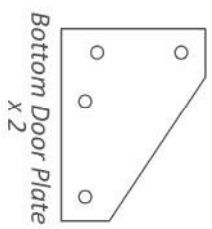
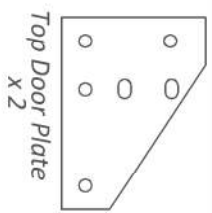
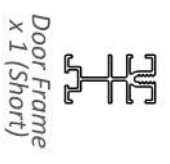
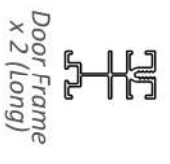

*If your Greenhouse has Commercial Bracing (Vertical Posts and/or Interlocked Horizontal Braces) proceed to the appropriate "Commercial Bracing" Instruction in the Accessories Section of the Manual*

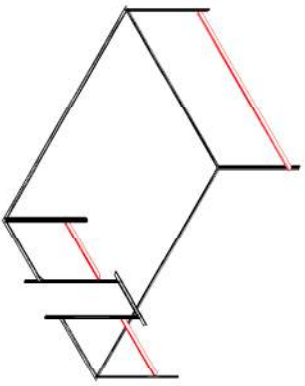

### STAGE 4: GABLE HORIZONTAL BRACES

- STEPS:**
1. CONNECT HORIZONTAL BRACE TO CORNER POST ON DOOR END GABLE.°
  2. CONNECT HORIZONTAL BRACE TO DOOR FRAME.
  3. REPEAT STEPS 1 & 2 ON OPPOSITE SIDE OF DOOR.
  4. CONNECT HORIZONTAL BRACE TO CORNER POSTS ON OPPOSITE GABLE.°

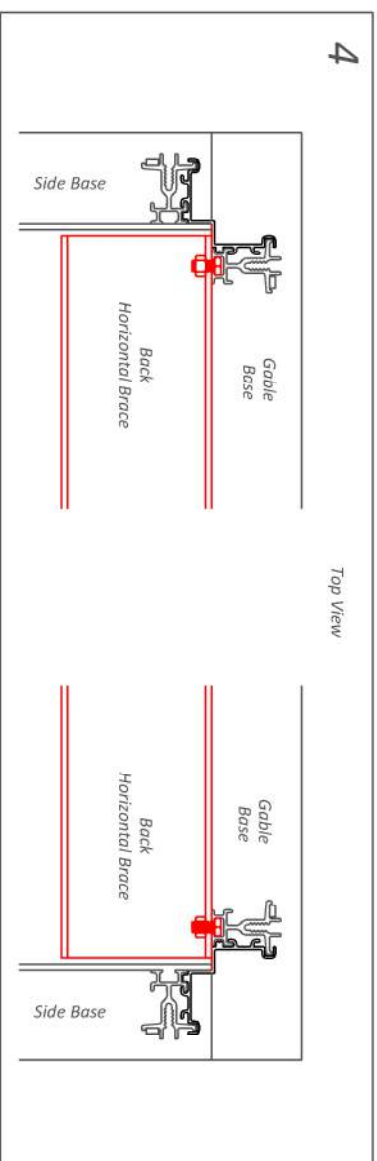
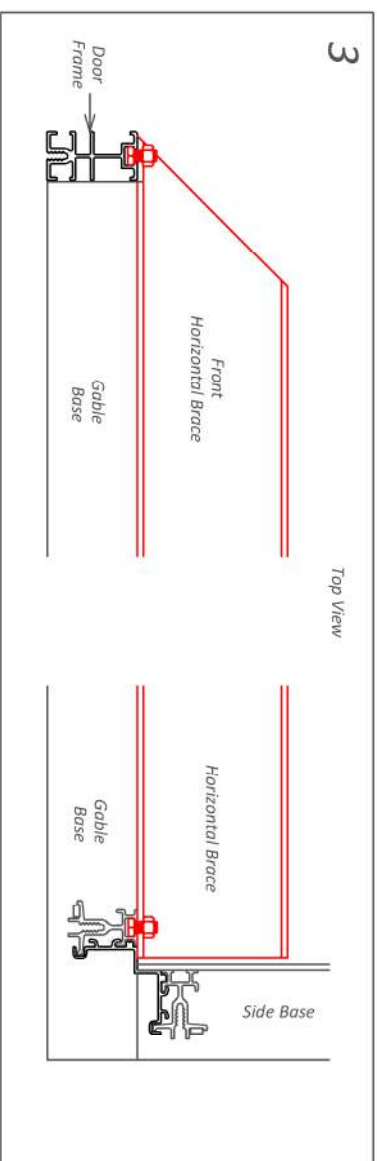
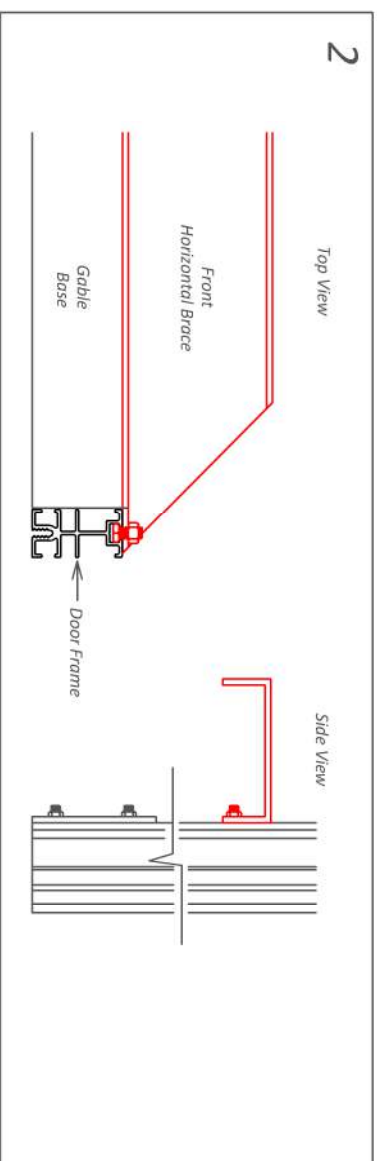
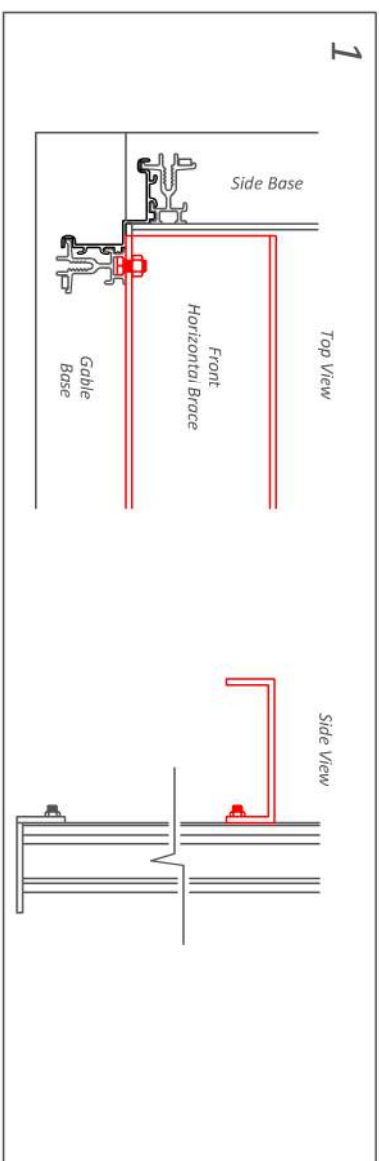
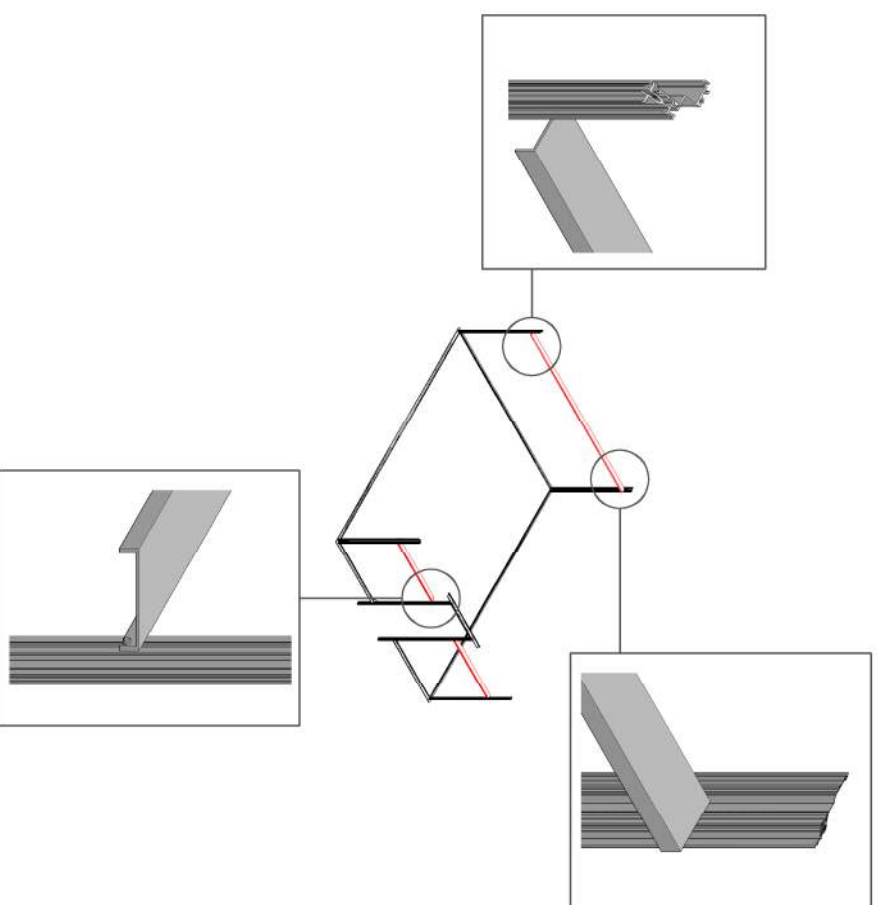

**PRO TIPS**

Correct heights for your Horizontal Braces will be indicated on your job specific drawings.

° Refer to the job-specific drawings provided for the recommended brace height.

**Parts List:**

Typical Horizontal Brace options:

- 1" x 2" Angle
- 1" x 2" Channel
- 1" x 3" Channel (illustrated)
- 1½" x 3" Channel
- ¼" x ½" S.S. Bolts & Nuts

- ¼" x ¾" S.S. Bolts & Nuts (only on 1½" x 3" Channel)



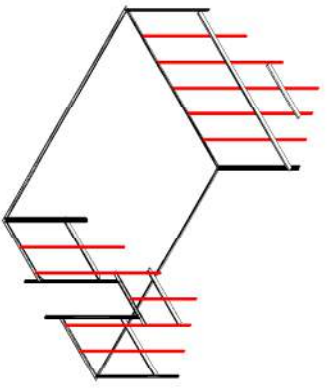

**STAGE 5: GABLE GLAZING BARS**

- STEPS:**
1. APPLY FOAM TAPE TO GLAZING BARS.
  2. ARRANGE GLAZING BARS IN ORDER.
  3. ATTACH THE FIRST GLAZING BAR TO THE BACK BASE / HORIZONTAL BRACE & REPEAT.
  4. ATTACH ANY REMAINING HORIZONTAL BRACES (IF APPLICABLE).
  5. REPEAT STEPS 3 & 4 FOR OPPOSITE END.

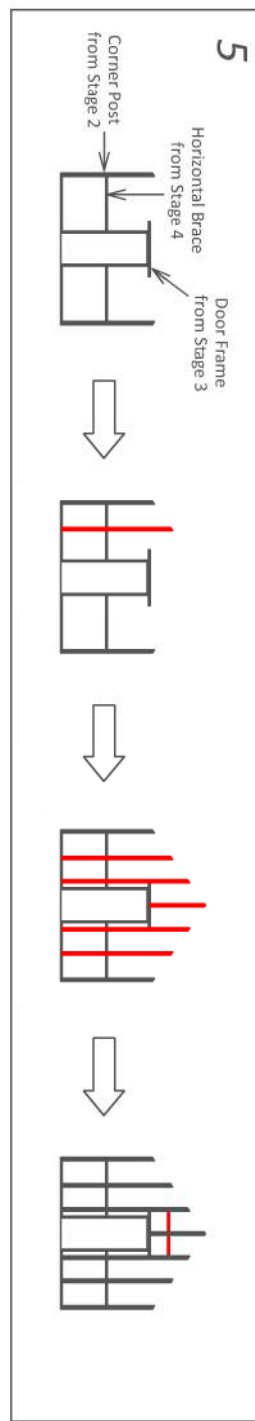
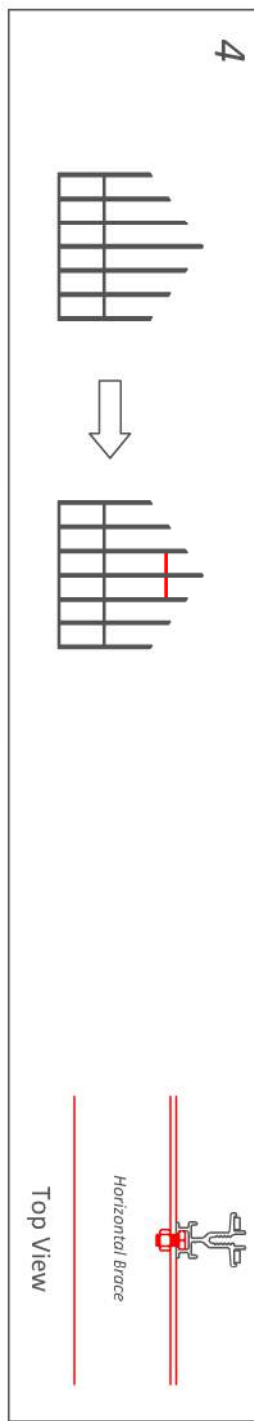
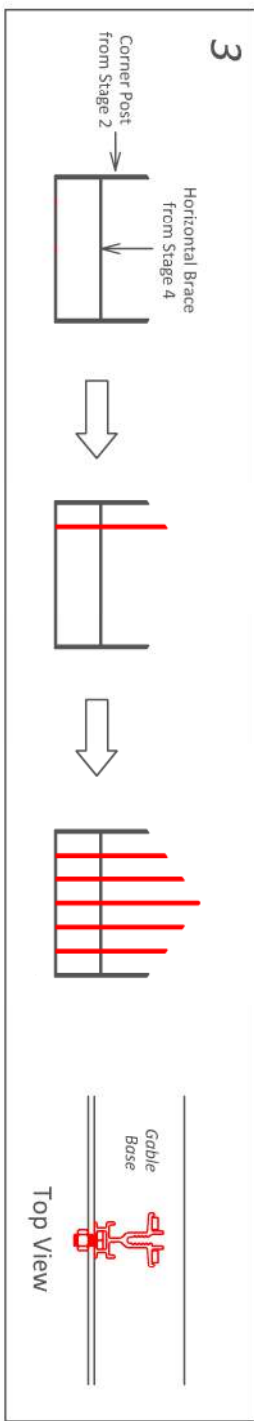
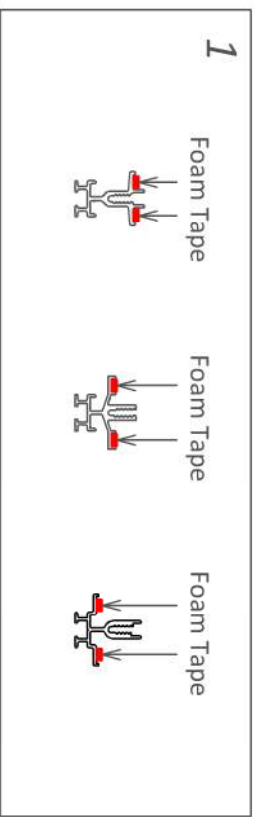
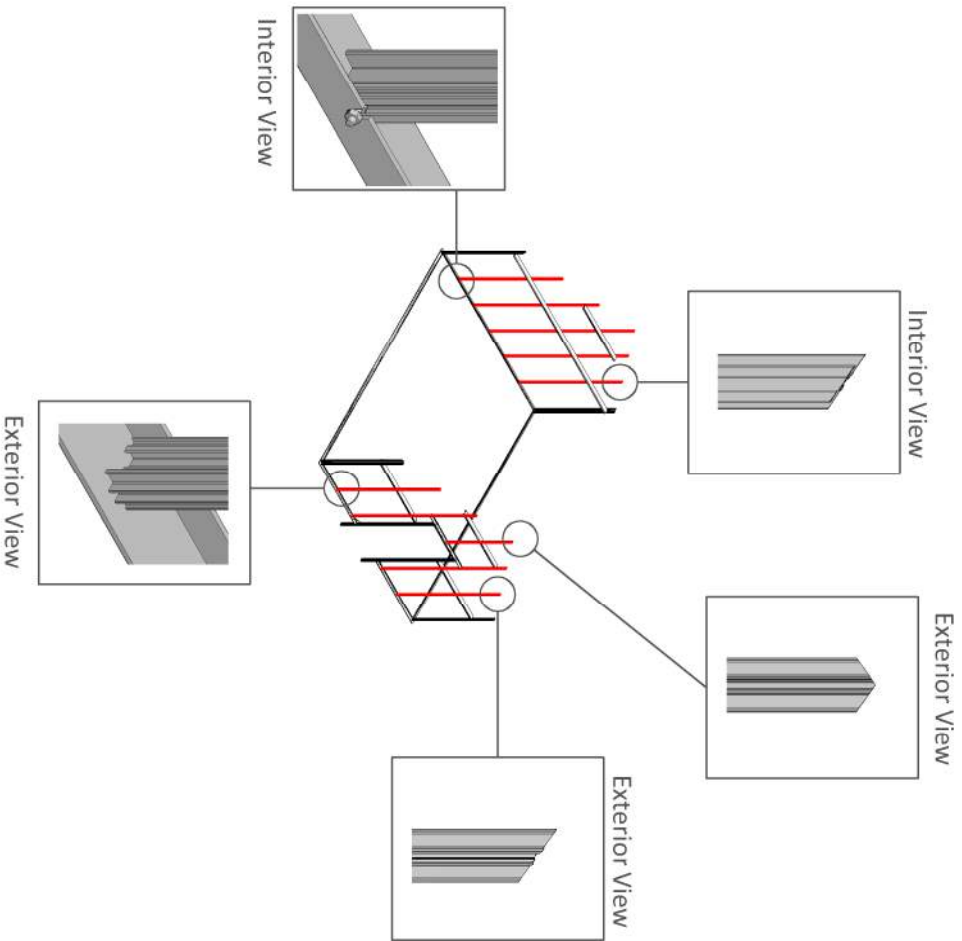

**PRO TIPS**



Apply Foam Tape to all Glazing Bars in advance to save yourself time during installation. (Just make sure you don't mix up your pieces)

Correct heights for your Horizontal Braces will be indicated on your job specific drawings.

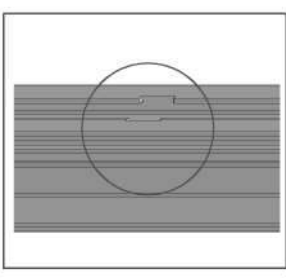
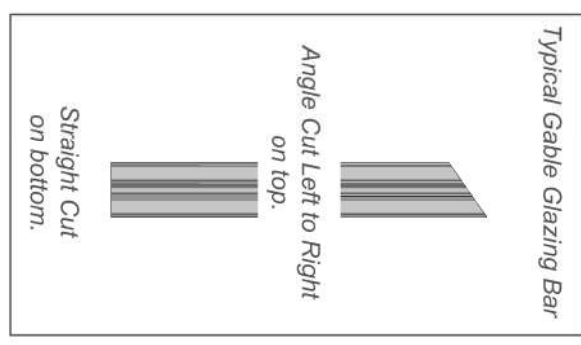

ALL GLAZING BARS ARE NOTCHED FOR INSERTING BOLT HEADS

**Parts List:**

-   
 Glazing Bar (3mm Single Glass)
-   
 Glazing Bar (6mm Twinwall Poly.)
-   
 Glazing Bar (6mm Single Glass)
-   
 Glazing Bar (16mm Fivewall Poly.)
-   
 Glazing Bar (16mm Double Glass)
-   
 Foam Tape
-   
 $\frac{1}{4}$ " x  $\frac{1}{2}$ " S.S. Bolts & Nuts

**PRO TIPS**



Make sure you have your gutters orientated in the right direction.

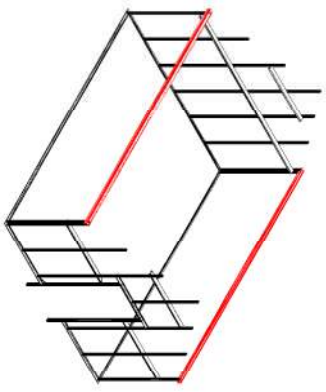

**STAGE 6: GUTTERS**



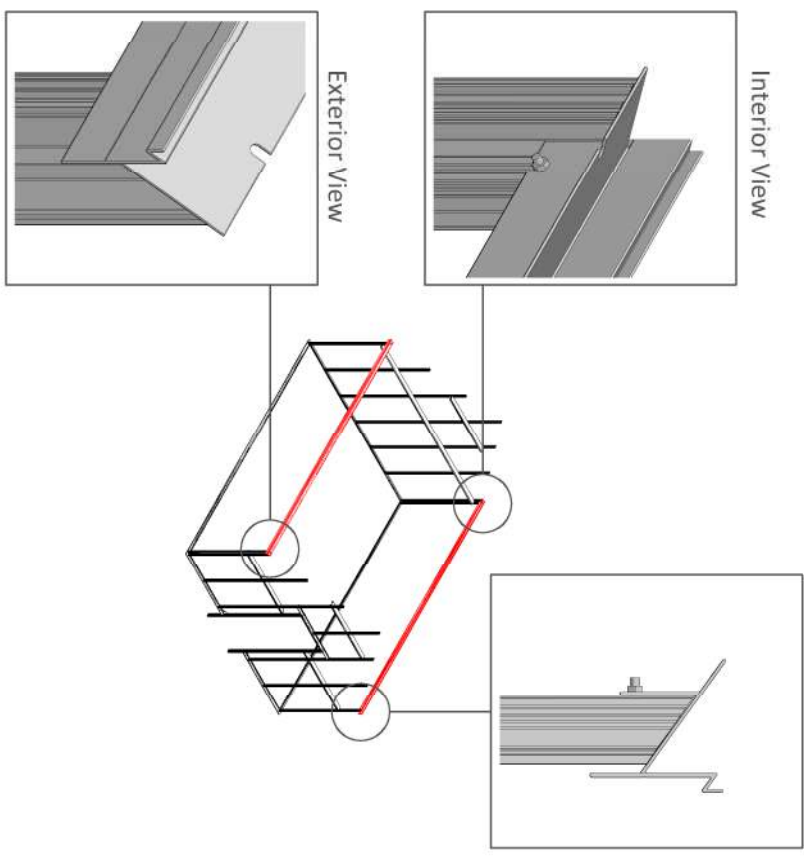
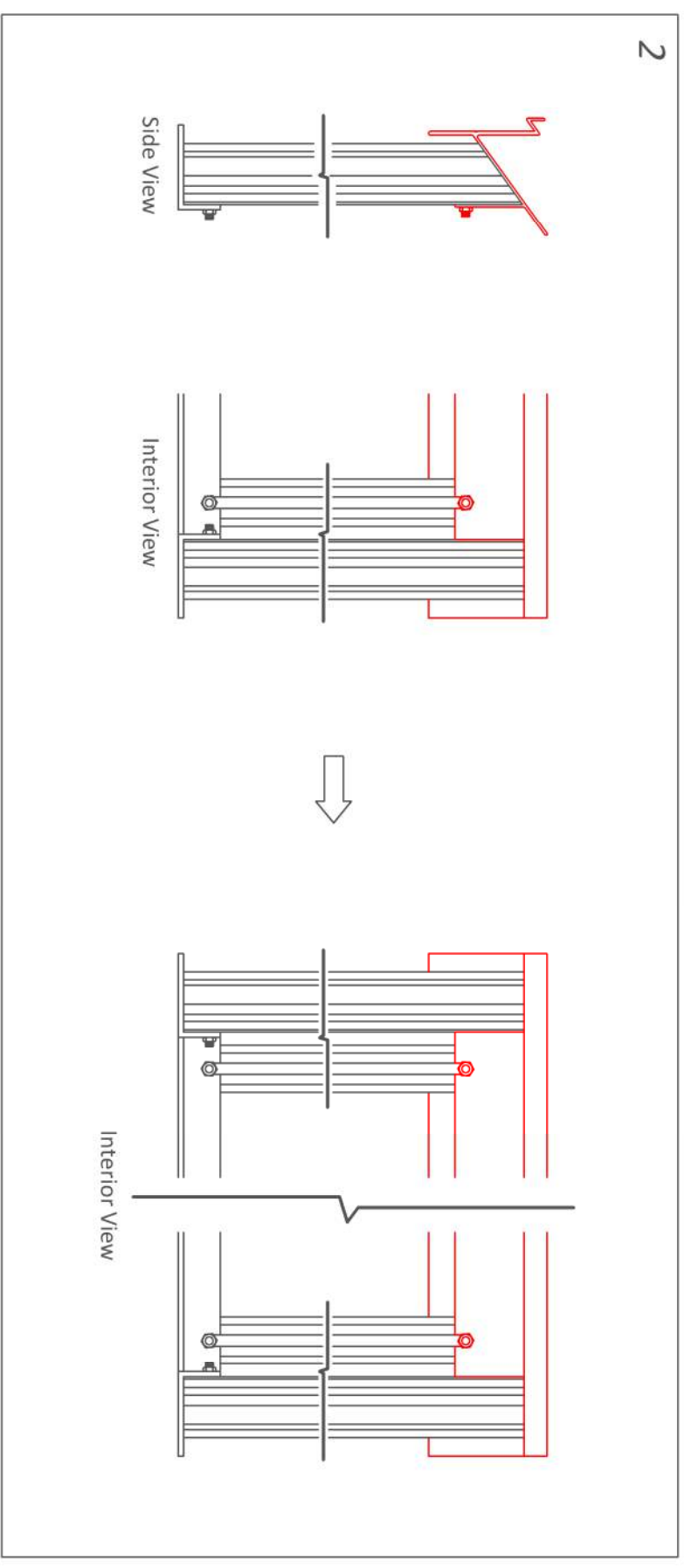
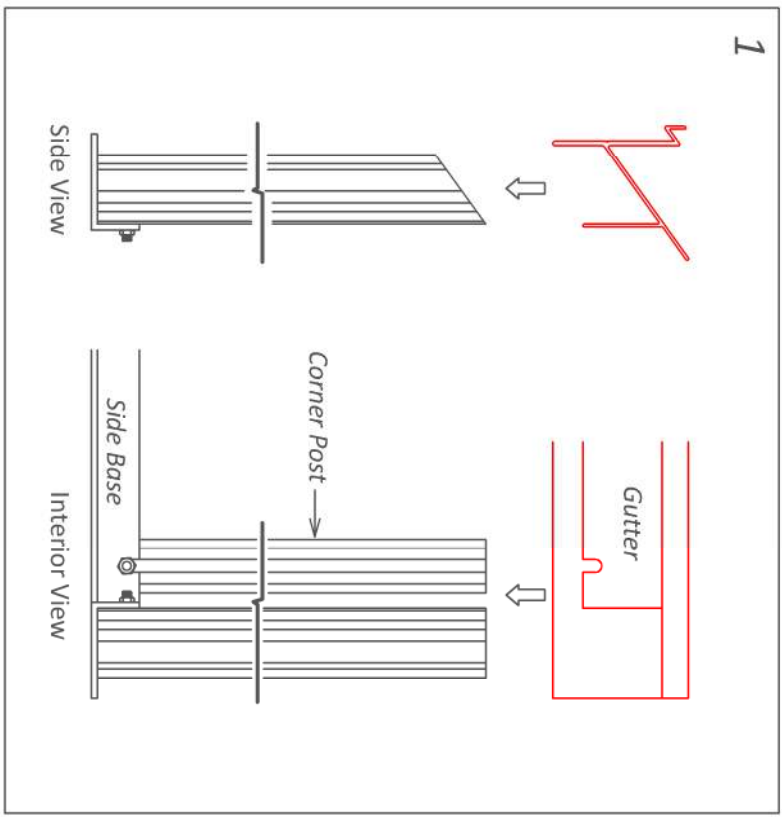

**STEPS:**

1. LOWER ONE GUTTER ONTO THE CORNER POSTS.\*
2. SECURE GUTTER TO CORNER POSTS.

REPEAT STEPS 1 & 2 FOR OPPOSITE GUTTER.

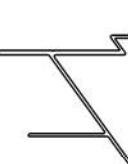
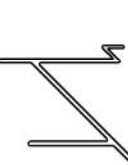

**Parts List:**

-   
 Gutter  
 (2.5 / 12 Slope)
  -   
 Gutter  
 (5 / 12 Slope)
  -   
 Gutter  
 (8.5 / 12 Slope)
  -   
 Gutter  
 (12 / 12 Slope)
- 
 4" x 1/2" S.S. Bolts & Nuts

\*On greenhouses over 12' in length, install one or two Side Wall Glazing Bars near the middle of the greenhouse to prevent the Gutters from sagging.

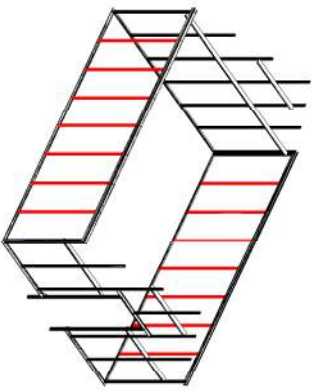

**STAGE 7: SIDE GLAZING BARS**

**STEPS:**

1. APPLY FOAM TAPE TO GLAZING BARS.
2. CONNECT REMAINING SIDE GLAZING BARS TO BASE & GUTTER.  
(GLAZING BAR SHOULD BE TIGHT TO BASE & GUTTER)

REPEAT FOR OPPOSITE SIDE WALL.

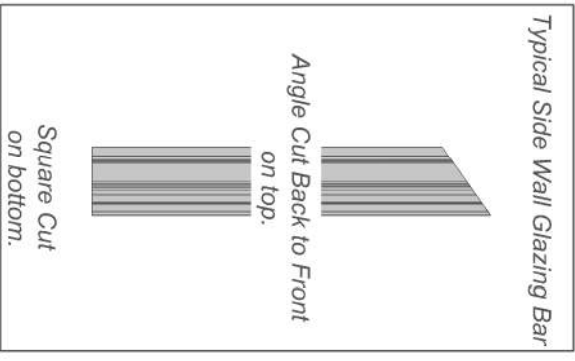
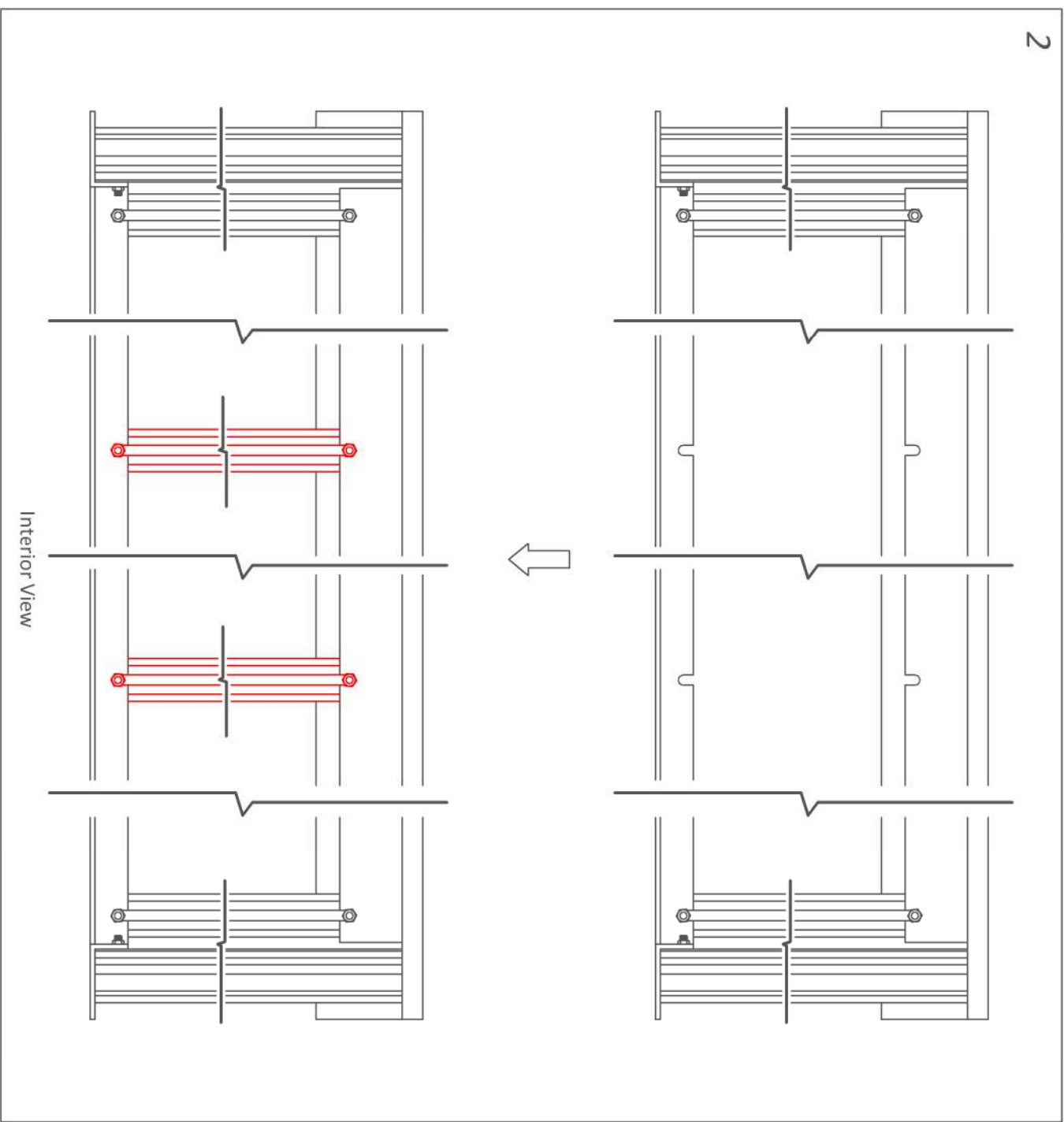
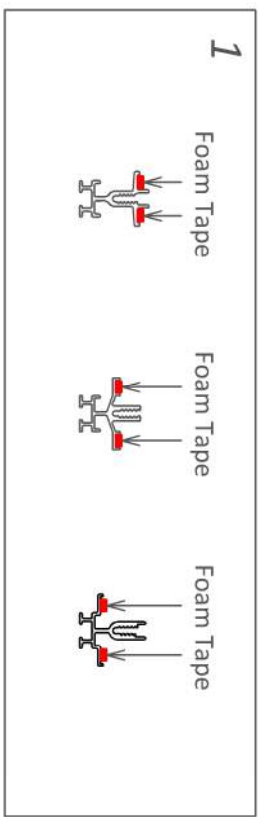
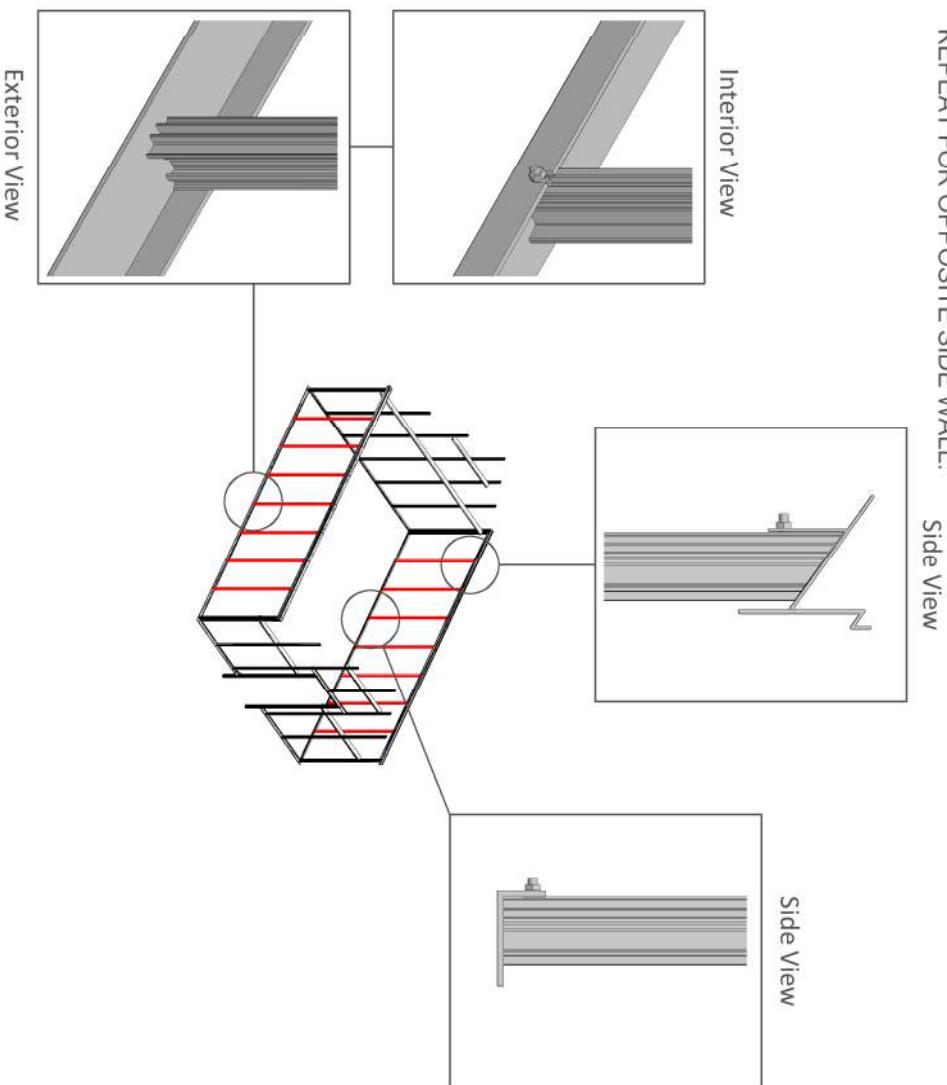

**Parts List:**

 Glazing Bar  
(3mm Single Glass)

 Glazing Bar  
(6mm Twinwall Poly.)

 Glazing Bar  
(6mm Single Glass)

 Glazing Bar  
(16mm Fivewall Poly.)

 Glazing Bar  
(16mm Double Glass)

 Foam Tape

  $\frac{1}{4}$ " x  $\frac{1}{2}$ " S.S. Bolts & Nuts

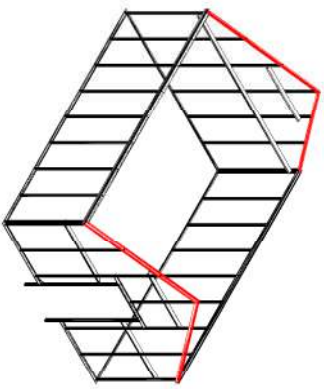

### STAGE 8: END RAFTERS

- STEPS:**
1. APPLY FOAM TAPE TO END RAFTER GLAZING BARS.
  2. PLACE THE END RAFTER ON TOP OF THE GABLE GLAZING BARS.
  3. SLIDE END RAFTER DOWN UNTIL IT FITS OVER GUTTER AND SECURE TO ALL BARS EXCEPT THE CENTER BAR (IF APPLICABLE).

REPEAT STEPS 2 & 3 FOR REMAINING END RAFTERS.

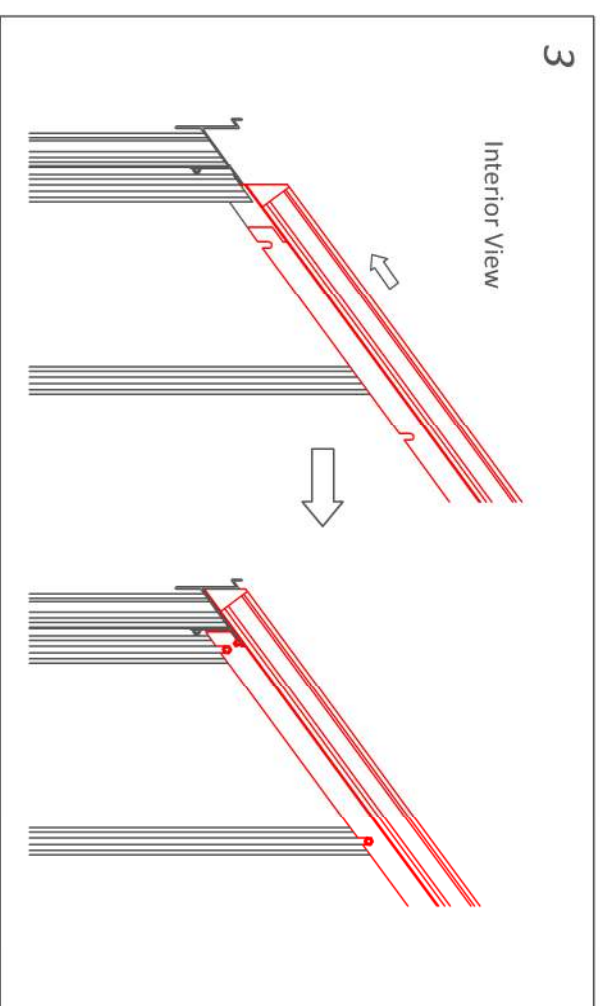
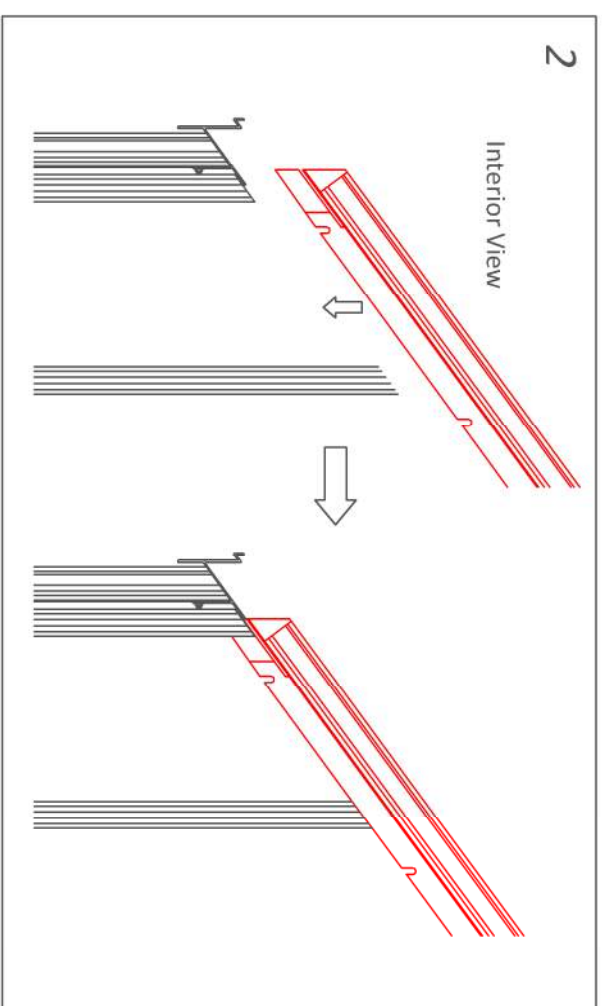
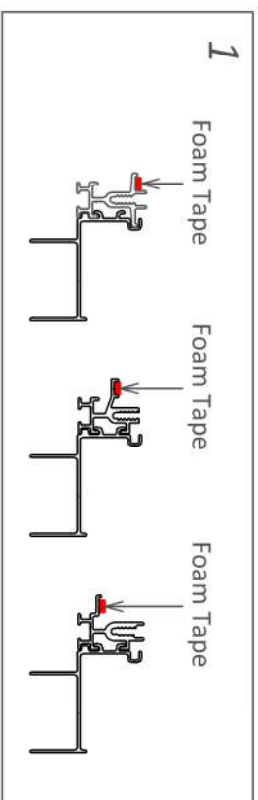
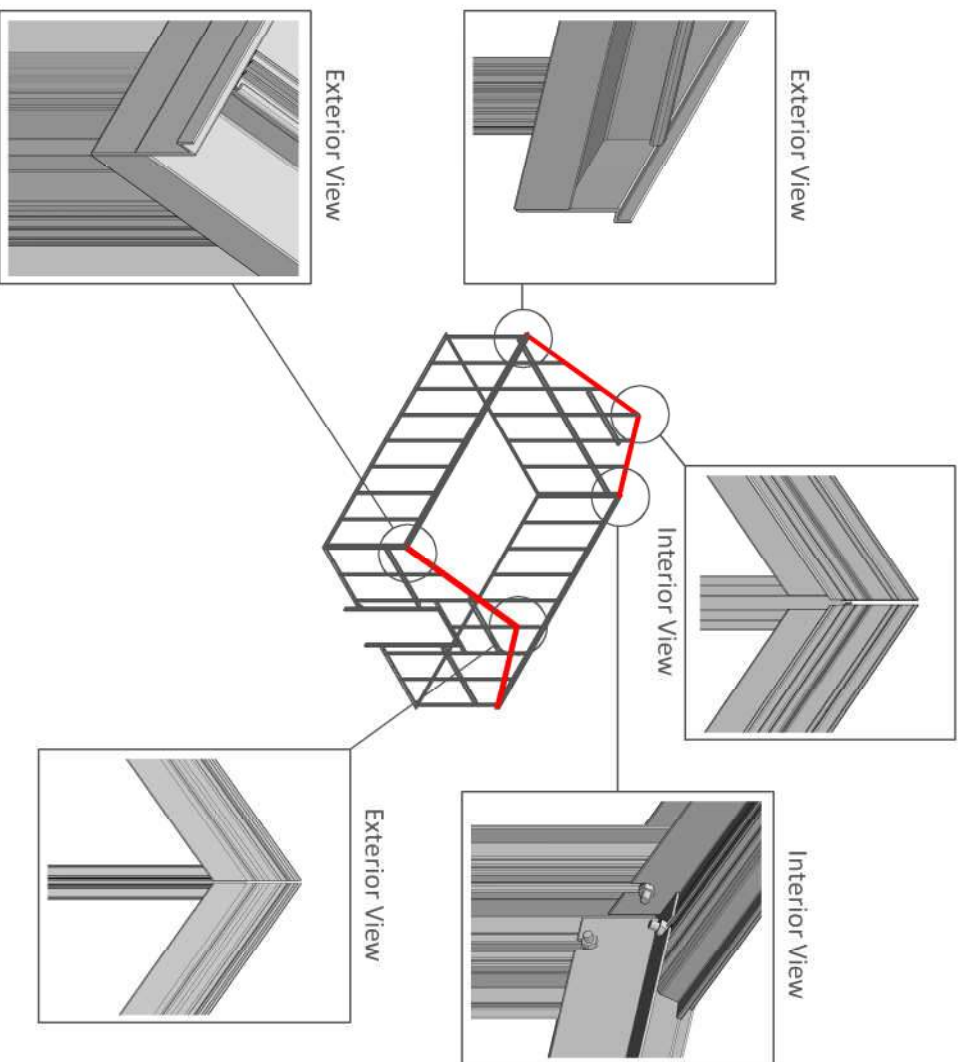

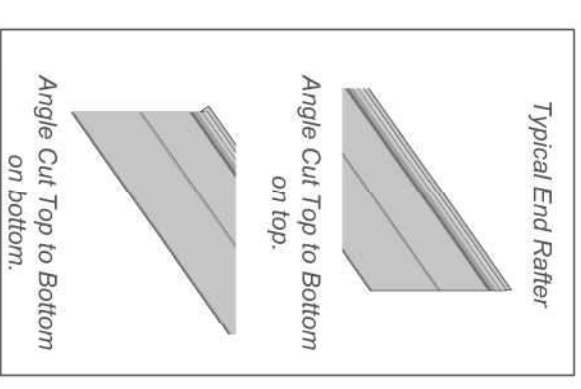

### PRO TIPS

Leave a gap of approximately  $\frac{1}{8}$ " to  $\frac{1}{4}$ " where the End Rafters meet so that the Ridge will fit between. You can tighten the gap once the Ridge is installed.

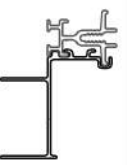
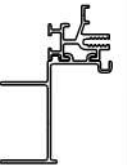
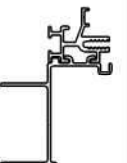
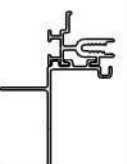
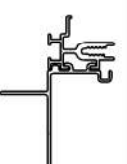

**Parts List:**

-   
 End Rafter  
 (3mm Single Glass)
-   
 End Rafter  
 (6mm Twinwall Poly.)
-   
 End Rafter  
 (6mm Single Glass)
-   
 End Rafter  
 (16mm Fivewall Poly.)
-   
 End Rafter  
 (16mm Double Glass)
-   
 Foam Tape
-   
 $\frac{1}{4}$ " x  $\frac{1}{2}$ " S.S. Bolts & Nuts

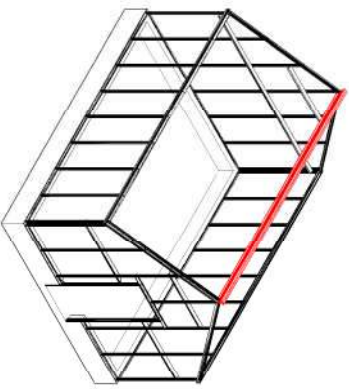

**STAGE 9: RIDGE**

- STEPS:**
1. SLIP THE RIDGE IN BETWEEN THE END RAFTERS AT ONE END OF THE GREENHOUSE THROUGH THE SLOTS CUT INTO THE END RAFTER.
  2. SECURE THE RIDGE TO THE END RAFTERS w/ (2) BOLTS & NUTS & SECURE END RAFTERS TO THE PEAK BAR w/ (1) BOLT, NUT & WASHER. (ENSURE THAT THE END RAFTER IS TIGHT TO THE RIDGE)

REPEAT FOR THE OPPOSITE END

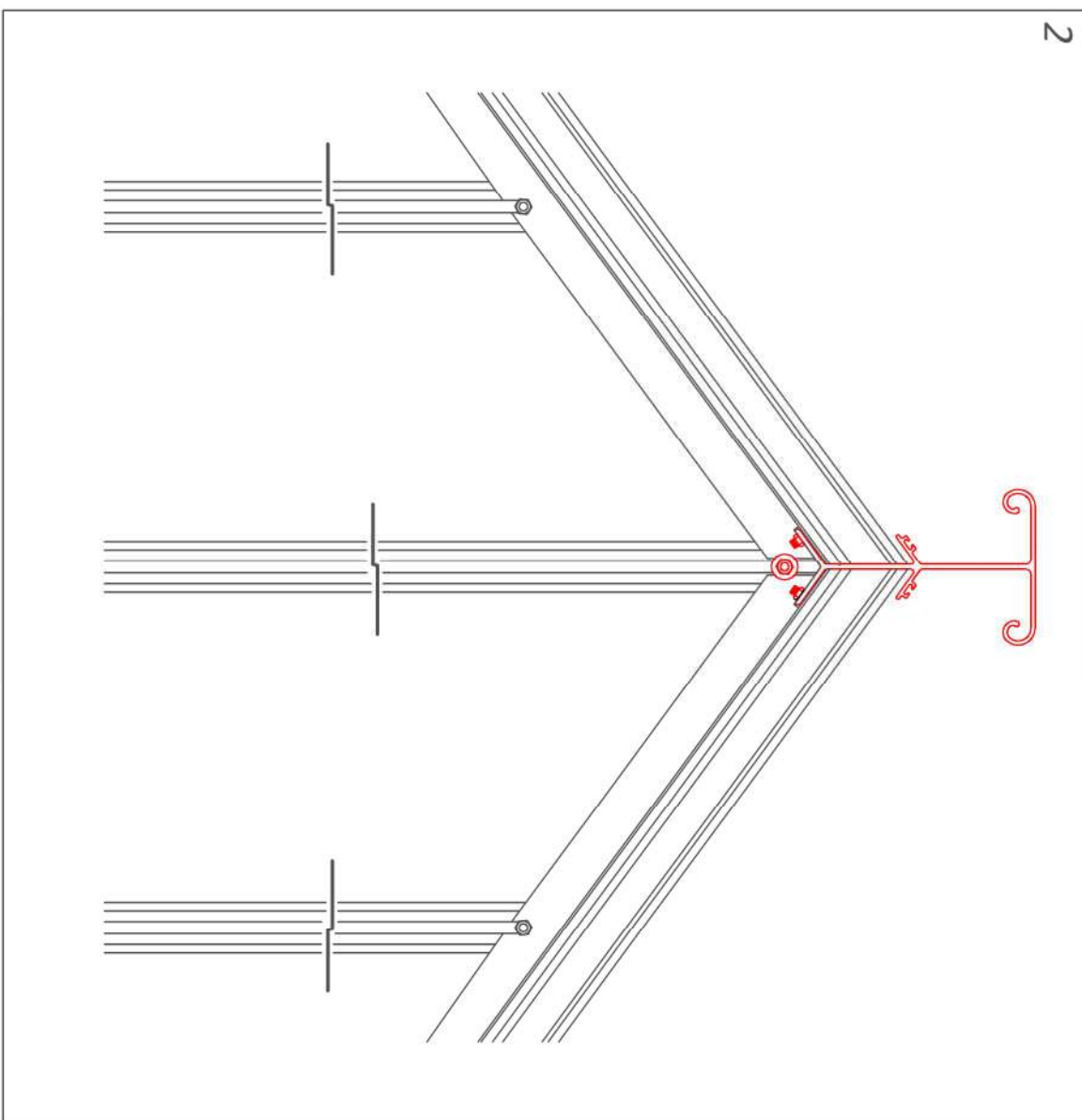
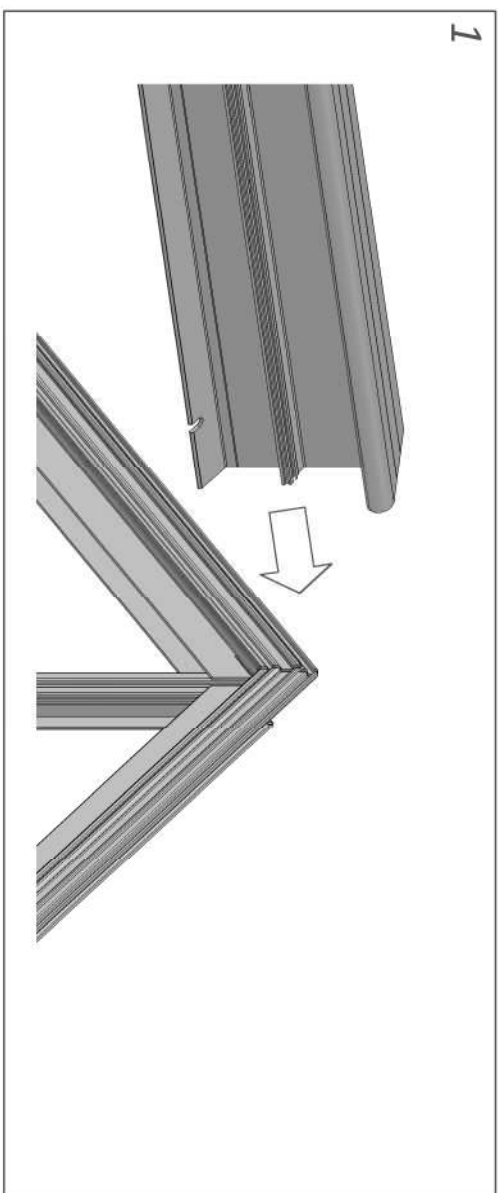
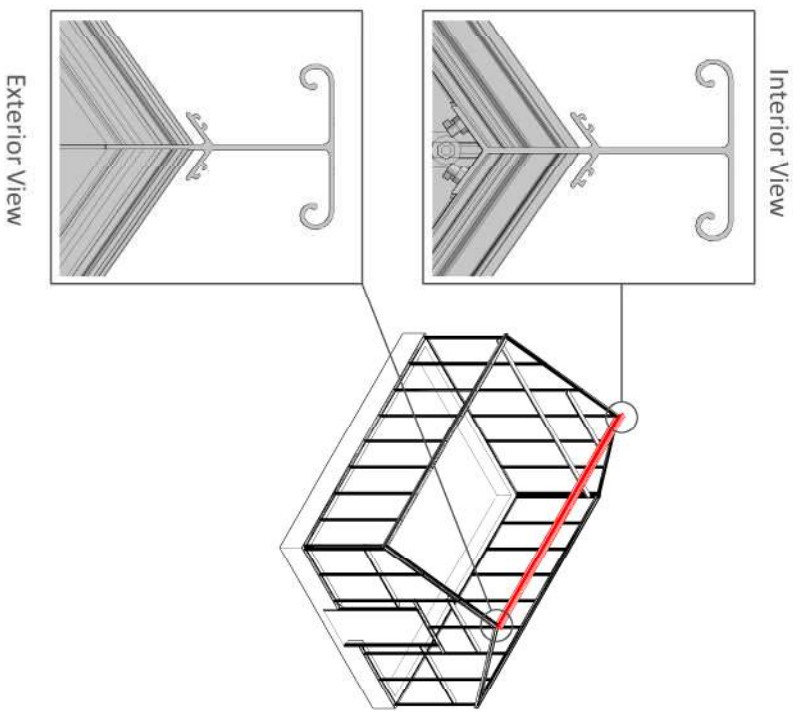

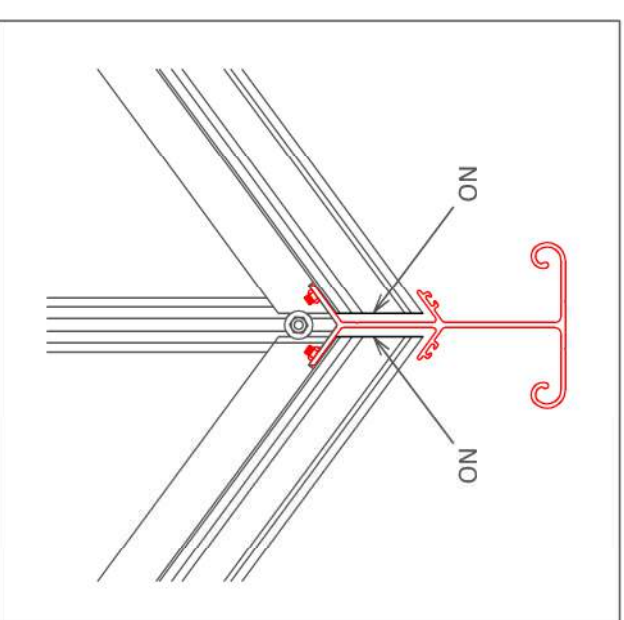
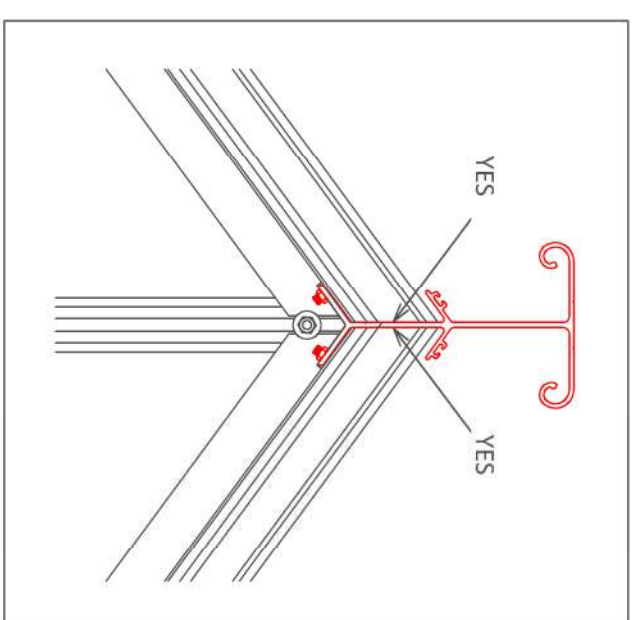

**PRO TIPS**

To make this step easier, position a ladder on each end of the greenhouse and work with a partner.

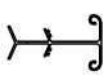
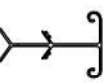
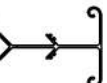
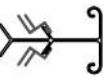
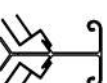

**Parts List:**

-  5 / 12 Ridge (3mm Single Glass)
-  8 / 12 Ridge (3mm Single Glass)
-  12 / 12 Ridge (3mm Single Glass)
-  Ridge (8.5 / 12 illustrated) (6mm Twinwall Poly or 6mm Single Glass)
-  Ridge (8.5 / 12 illustrated) (16mm Fivewall Poly or 16mm Double Glass)
-  1" x 1/2" S.S. Bolts & Nuts
-  1" Washer



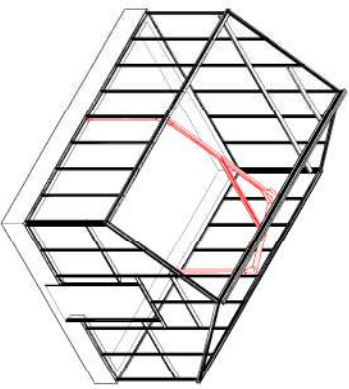

**STAGE 10A: TRUSS (if applicable)**

- STEPS:**
1. PLACE ONE TRUSS POST BESIDE THE APPROPRIATE SIDE GLAZING BAR.\*
  2. CONNECT THE SIDE WALL CLEAT TO THE SIDE GLAZING BAR w/  $\frac{1}{4}$ " x  $\frac{1}{2}$ " BOLTS & NUTS.
  3. REPEAT STEPS 1 & 2 FOR THE OPPOSITE SIDE.

TURN TO NEXT PAGE

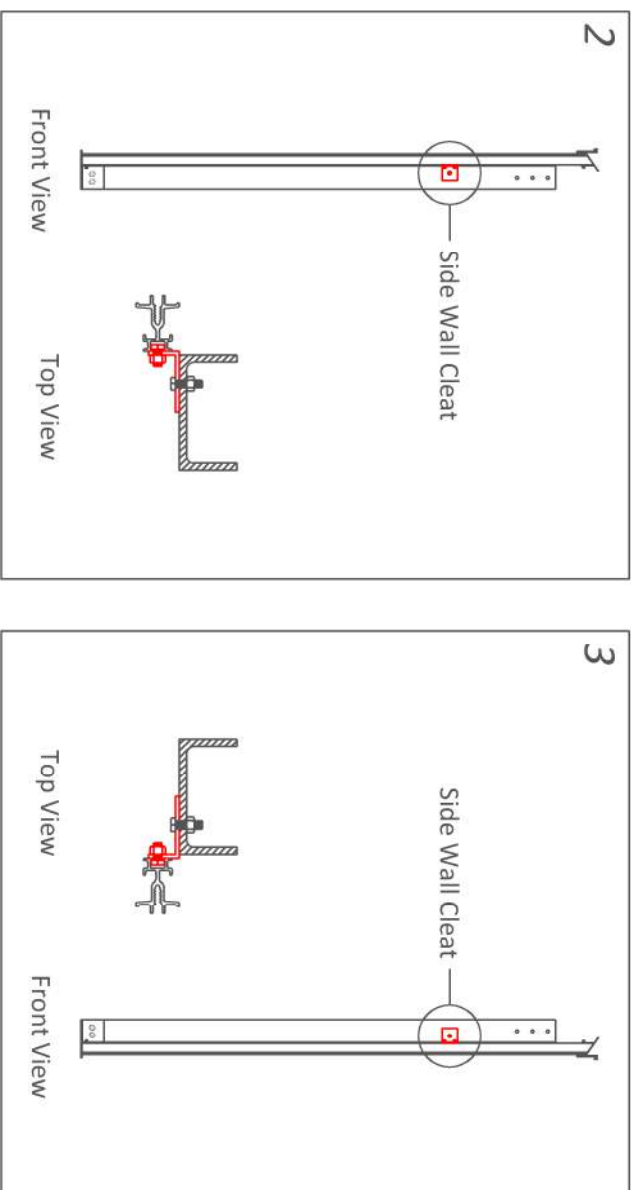
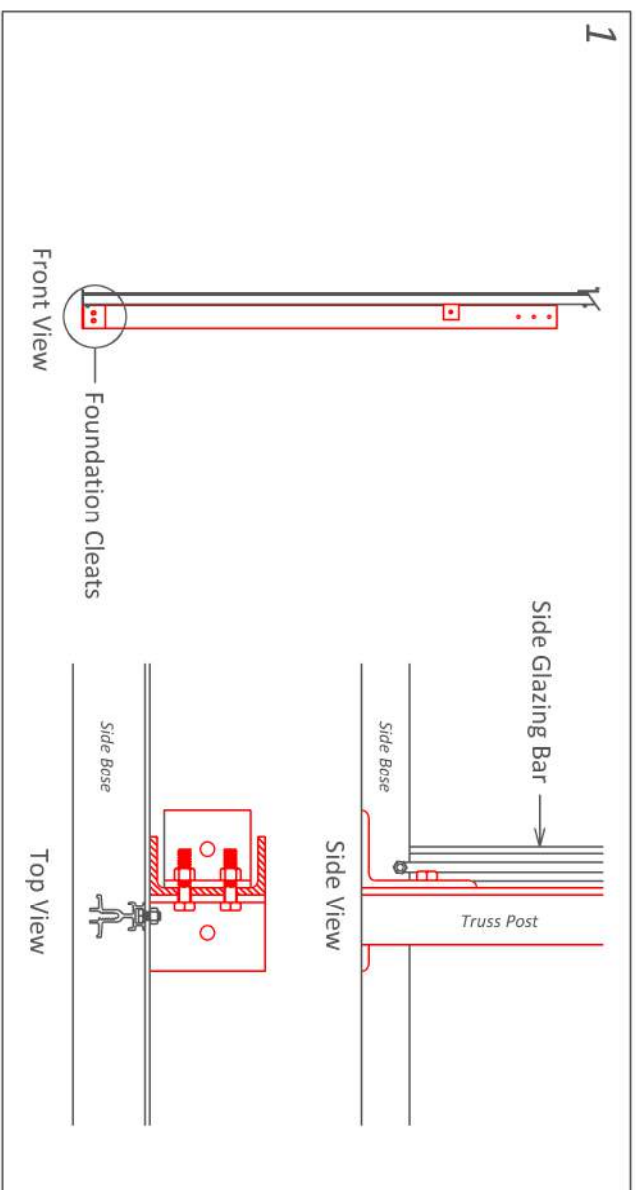
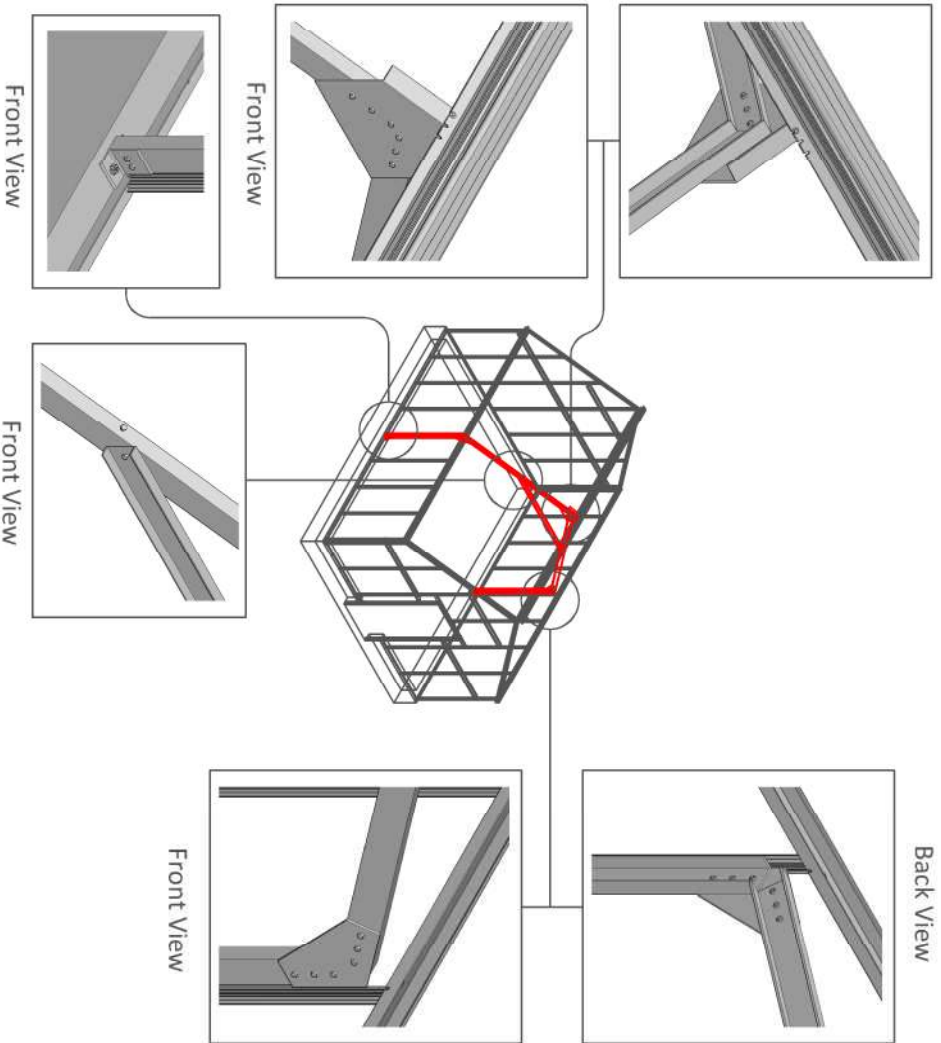

**PRO TIPS**

The Truss on every model of greenhouse is slightly different. Refer to your Job Specific drawings frequently during this stage.

*If your Truss looks similar to this, refer to the "Commercial Truss" Instruction in the Accessories Section of the Manual*

- Parts List:**  
*(Typical non-commercial Truss)*
- Truss Post (x 2)
  - Top Chord (x 2)
  - Collar Tie (x 1)
  - Corner Plates (1 pair)
  - Peak Plates (x 1)
  - $\frac{1}{4}$ " x  $\frac{1}{2}$ " S.S. Bolts & Nuts (x 4)
  - $\frac{1}{4}$ " x  $\frac{3}{4}$ " S.S. Bolts & Nuts (x 2)
  - $\frac{1}{4}$ " Washer (x 2)
  - $\frac{3}{8}$ " x  $1\frac{1}{4}$ " S.S. Bolts & Nuts (x 20)



**PRO TIPS**



Do not tighten the bolts at this stage more than finger-tight. You may have to adjust the truss as you progress.

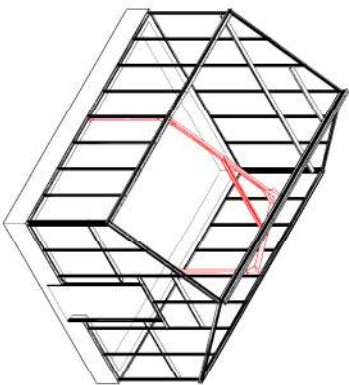

**STAGE 10B: TRUSS (if applicable)**

**STEPS:**

4. ATTACH CORNER PLATES TO POSTS w/  $\frac{3}{8}$ " x  $1\frac{1}{4}$ " BOLTS & NUTS.  
REPEAT FOR THE OPPOSITE SIDE.
5. ATTACH THE PEAK PLATE TO THE RIDGE w/  $\frac{1}{4}$ " x  $\frac{3}{4}$ " BOLTS, NUTS & WASHERS.
6. ATTACH ONE TOP CHORD TO THE CORNER PLATE w/  $\frac{3}{8}$ " x  $1\frac{1}{4}$ " BOLTS & NUTS.
7. ATTACH THE TOP TOP CHORD TO THE PEAK PLATE w/  $\frac{3}{8}$ " x  $1\frac{1}{4}$ " BOLTS & NUTS.
8. REPEAT STEPS 6 & 7 FOR THE OPPOSITE SIDE.

TURN TO NEXT PAGE

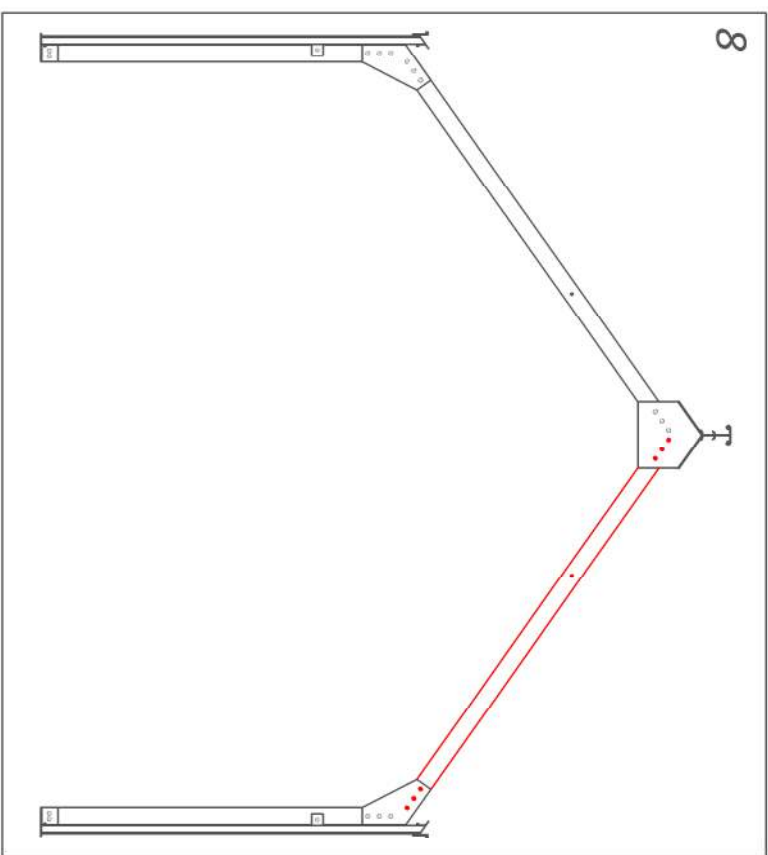
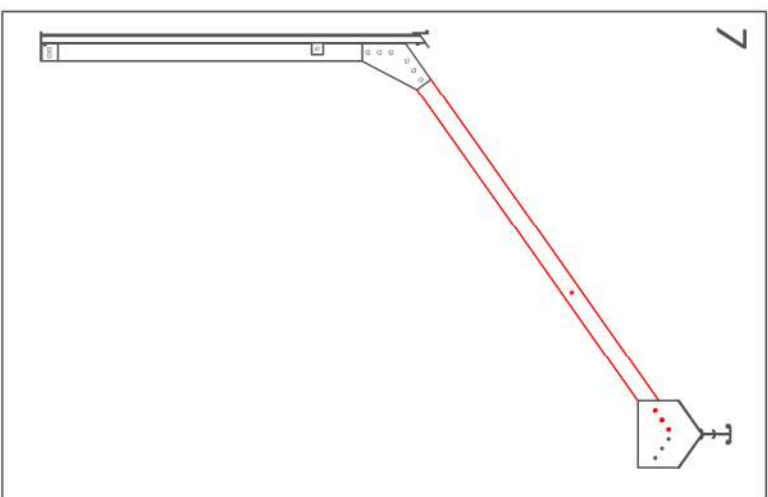
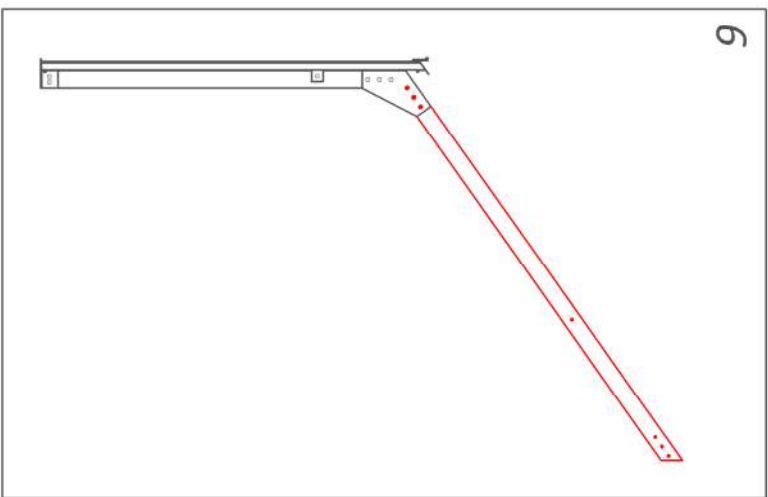
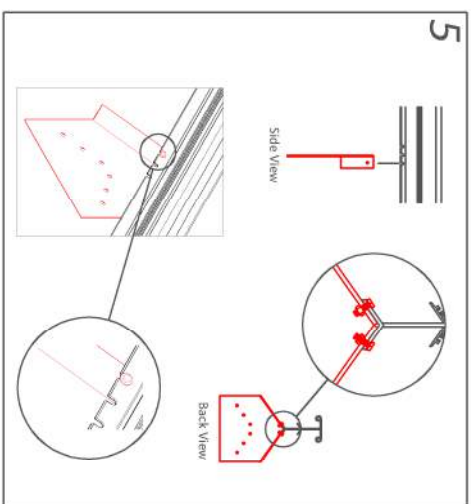
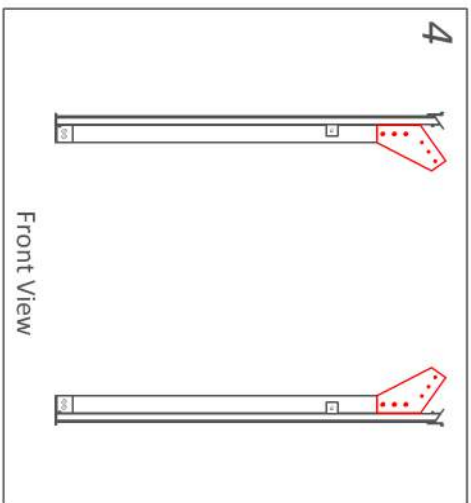

**Parts List:**

(Typical non-commercial Truss)

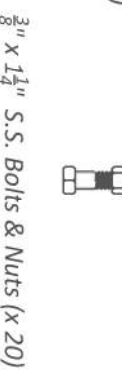
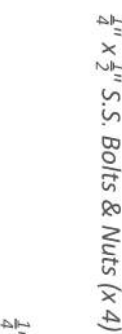
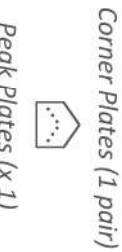
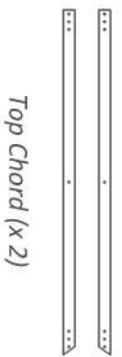

PRO TIPS



Do not use an Impact Driver when tightening your truss fasteners as it can cause the nuts to seize.

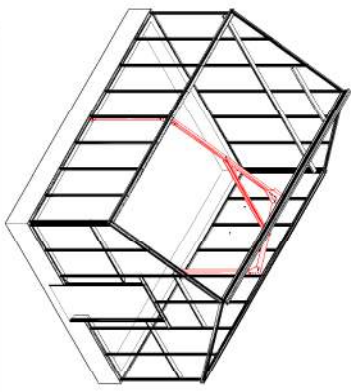

STAGE 10C: TRUSS (if applicable)

STEPS:

- 9. ATTACH THE COLLAR TIE TO THE TOP CHORDS w/  $\frac{3}{8}$ " x  $1\frac{1}{4}$ " BOLTS & NUTS.
  - 10. VERIFY THAT TRUSS WIDTH IS EQUAL AT THE BASE AND GUTTER & MATCH JOB SPECIFIC DRAWINGS.
- ONCE WIDTHS ARE EQUAL, TIGHTEN ALL BOLTS.

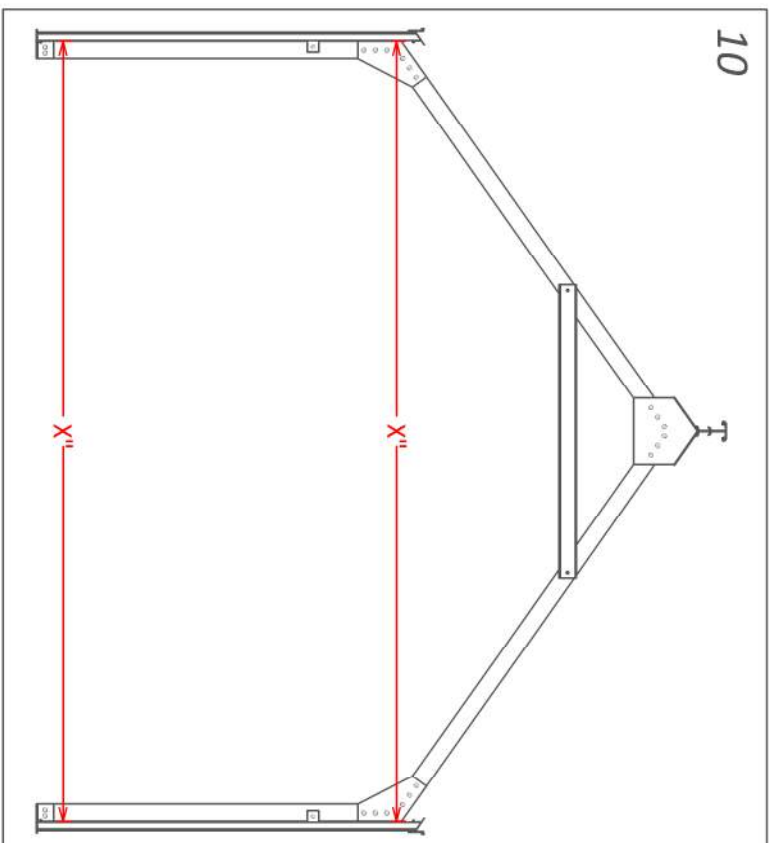
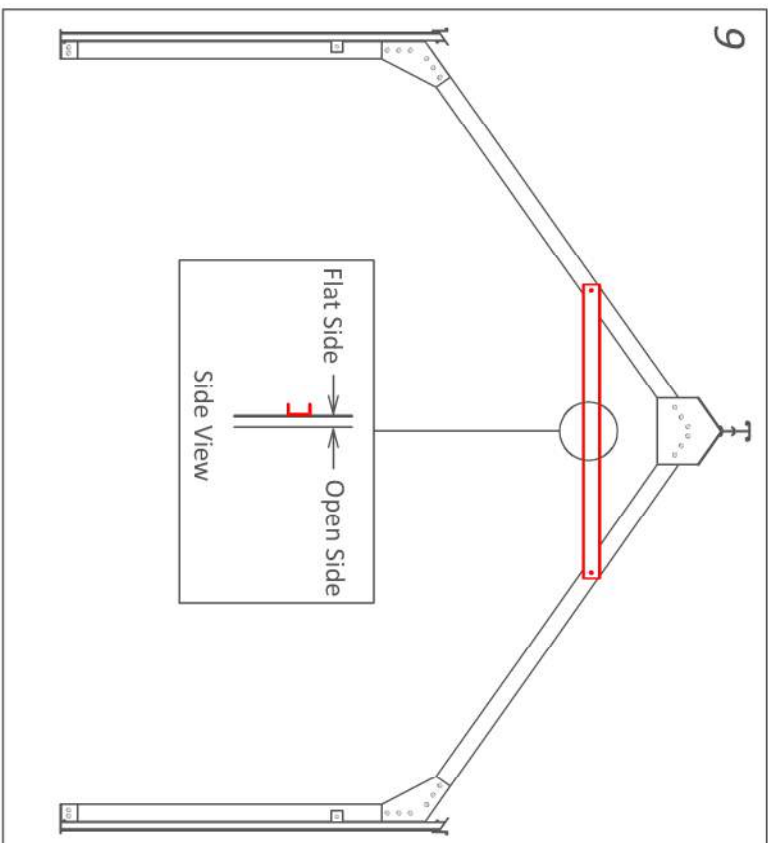

Parts List:

(Typical non-commercial Truss)



Truss Post (x 2)

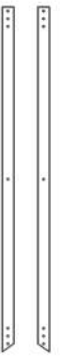

Top Chord (x 2)



Collar Tie (x 1)



Corner Plates (1 pair)



Peak Plates (x 1)



$\frac{1}{4}$ " x  $\frac{1}{2}$ " S.S. Bolts & Nuts (x 4)



$\frac{1}{4}$ " x  $\frac{3}{4}$ " S.S. Bolts & Nuts (x 2)



$\frac{1}{4}$ " Washer (x 2)



$\frac{3}{8}$ " x  $1\frac{1}{4}$ " S.S. Bolts & Nuts (x 20)



**PRO TIPS**



Refer to you Job Specific Drawings for your exact Anchor Dimensions.

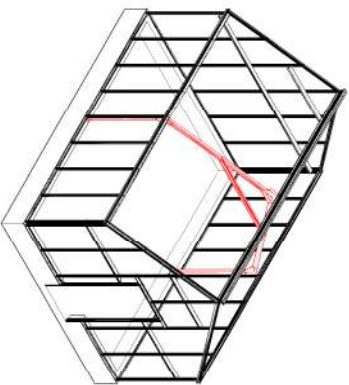

**STAGE 10D: TRUSS ANCHORING (if applicable)  
VERTICAL POST ANCHORING (if applicable)**

**Wood Foundation**

- STEPS:**  
 12. DRILL A HOLE IN FOUNDATION USING EXISTING HOLES IN TRUSS CLEAT AS A PILOT.  
 13. FASTEN TRUSS TO FOUNDATION W/ LAG BOLTS & WASHERS.

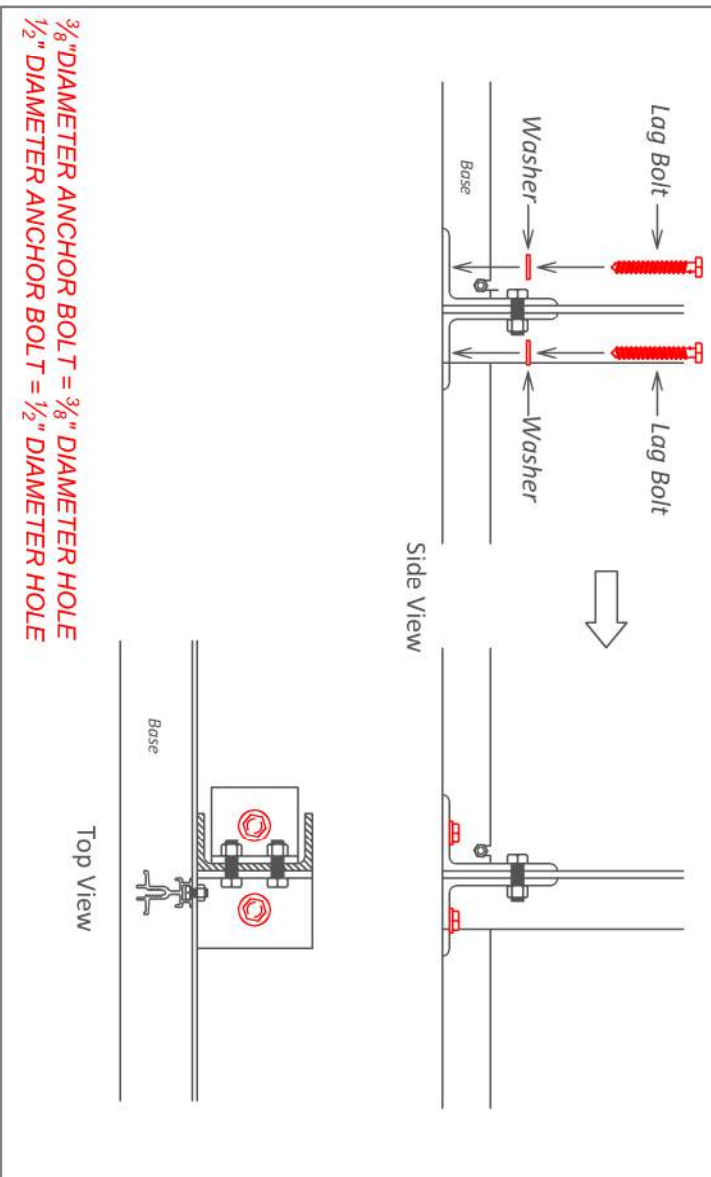

**Concrete Foundation**

- STEPS:**  
 12. DRILL A HOLE IN FOUNDATION USING EXISTING HOLES IN TRUSS CLEAT AS A PILOT.  
 13. ATTACH NUT & WASHER TO ANCHOR.  
 14. HAMMER ANCHOR INTO FOUNDATION.  
 15. TIGHTEN NUTS.

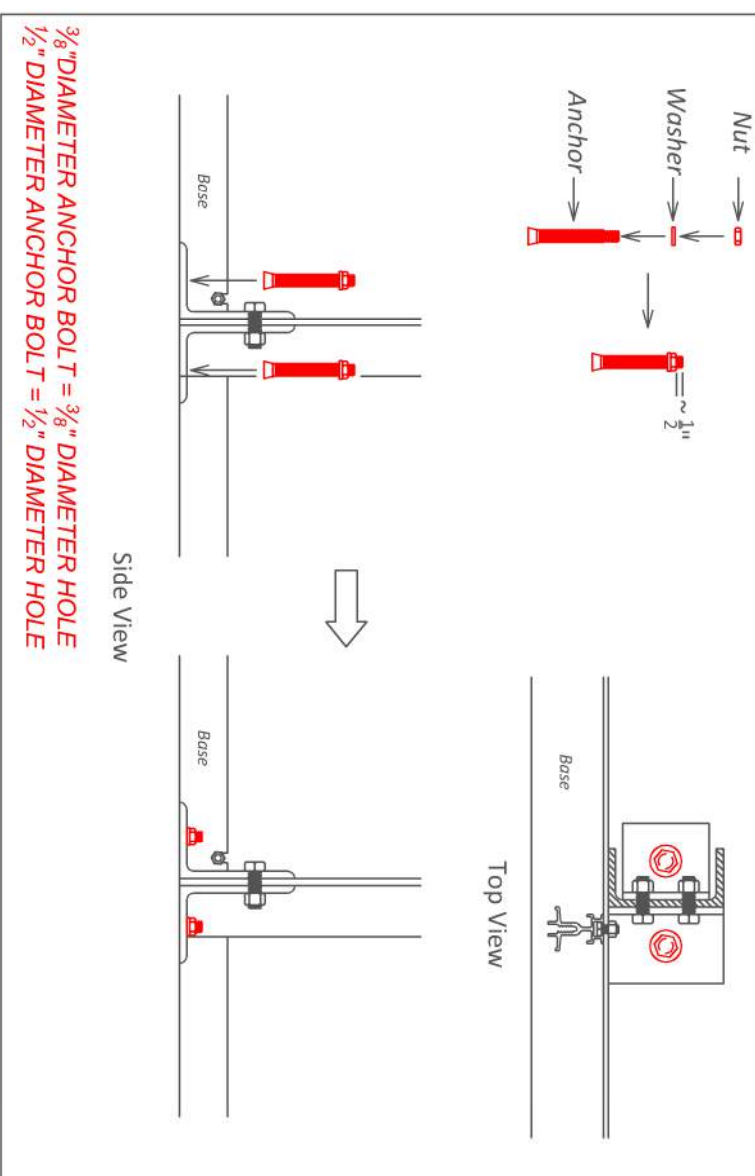

**Parts List:**

(Typical non-commercial Truss)



Lag Bolt & Washer



Concrete Anchor w/ Nut & Washer

**PRO TIPS**



Not all greenhouses have Purlins and some have many. Refer to your job-specific drawings for the Purlin Type and Quantity that applies to your exact greenhouse.

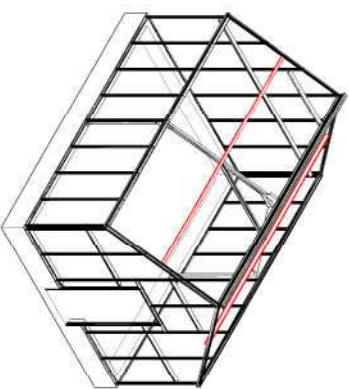

**STAGE 11: PURLINS**

**STEPS:**

1. MOVE PURLIN INTO APPROXIMATE POSITION BELOW END RAFTERS (BUT ABOVE TRUSS).\*
2. INSERT APPROPRIATE BOLT INTO THE TRACK ON THE UNDERSIDE OF THE END RAFTER & CONNECT THE PURLIN TO THE END RAFTER. (REPEAT FOR BOTH ENDS)
3. CONNECT PURLIN TO TRUSS TOP CHORD (IF APPLICABLE)

REPEAT FOR REMAINING PURLIN(S)

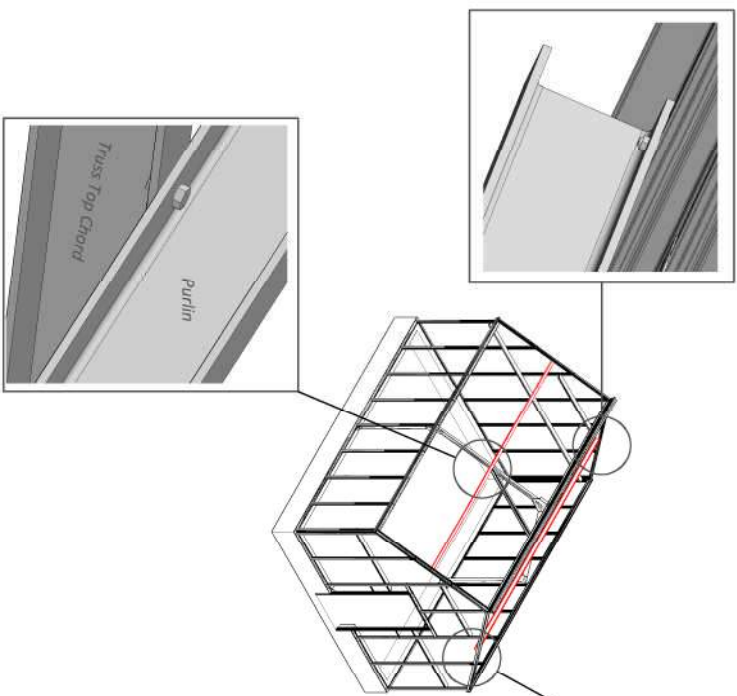
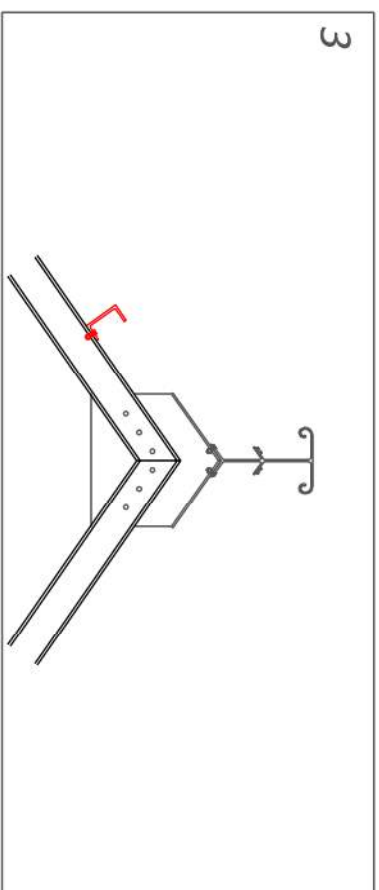
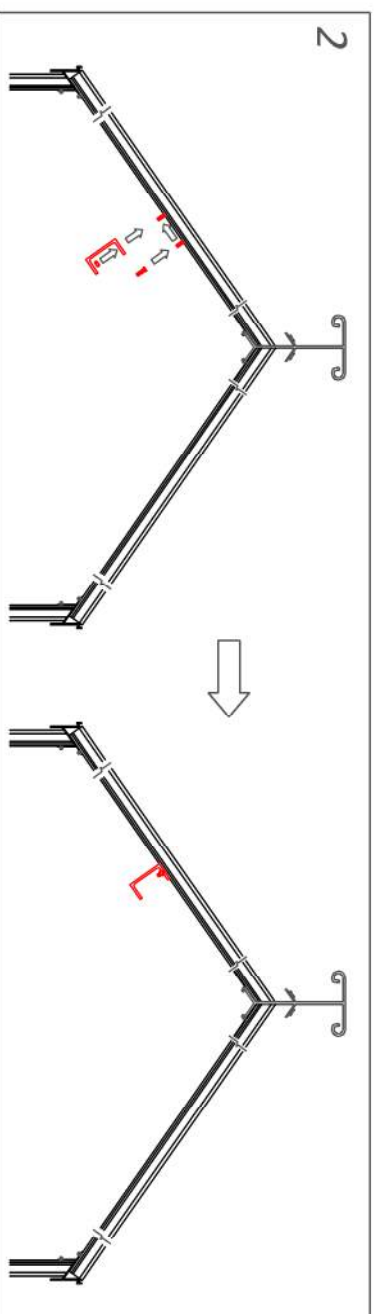
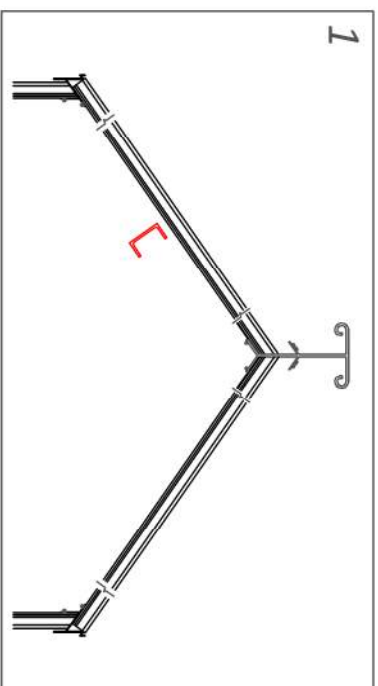

**Parts List:**

*Typical Purlin Options*

1" x 2" x 1/8" Channel (Purlin)

1/4" x 1/2" S.S. Bolts & Nuts  
(Connecting to End Rafters)

1" x 3" x 1/8" Channel (Purlin)

1/4" x 1/2" S.S. Bolts & Nuts  
(Connecting to End Rafters)

1/4" x 3/4" S.S. Bolts & Nuts  
(Connecting to Truss)

1 1/2" x 3" x 3/16" Channel (Purlin)

1/4" x 3/4" S.S. Bolts & Nuts  
(Connecting to End Rafters)

3/8" x 1 1/4" S.S. Bolts & Nuts  
(Connecting to Truss)

\* Proper Purlin location is indicated on your job -specific drawings, generally as a measurement from the Ridge to the center of the Purlin. If your greenhouse has a Truss, the correct Purlin location can also be determined by the location of the holes drilled in the uppermost surface of the Truss Top Chord

**PRO TIPS**



The Roof Vent Slider Sliders will come pre-attached to the Roof Glazing Bars. Do not remove them.

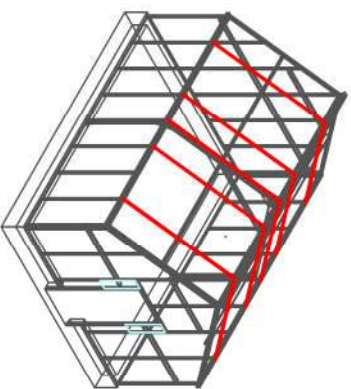

**STAGE 12: ROOF GLAZING BARS - UNDER RIDGE**

**STEPS:**

1. APPLY FOAM TAPE TO ALL GLAZING BARS.
2. ATTACH GLAZING BAR WITH VENT SLIDER #1 TO THE CORRESPONDING SPOT #1 ON THE RIDGE, PURLIN & GUTTER. (Purlin & Gutter will not be numbered)

REPEAT FOR REMAINING GLAZING BARS WITH VENT SLIDERS

3. ATTACH GLAZING BARS WITHOUT VENT SLIDERS TO RIDGE, PURLIN & GUTTER



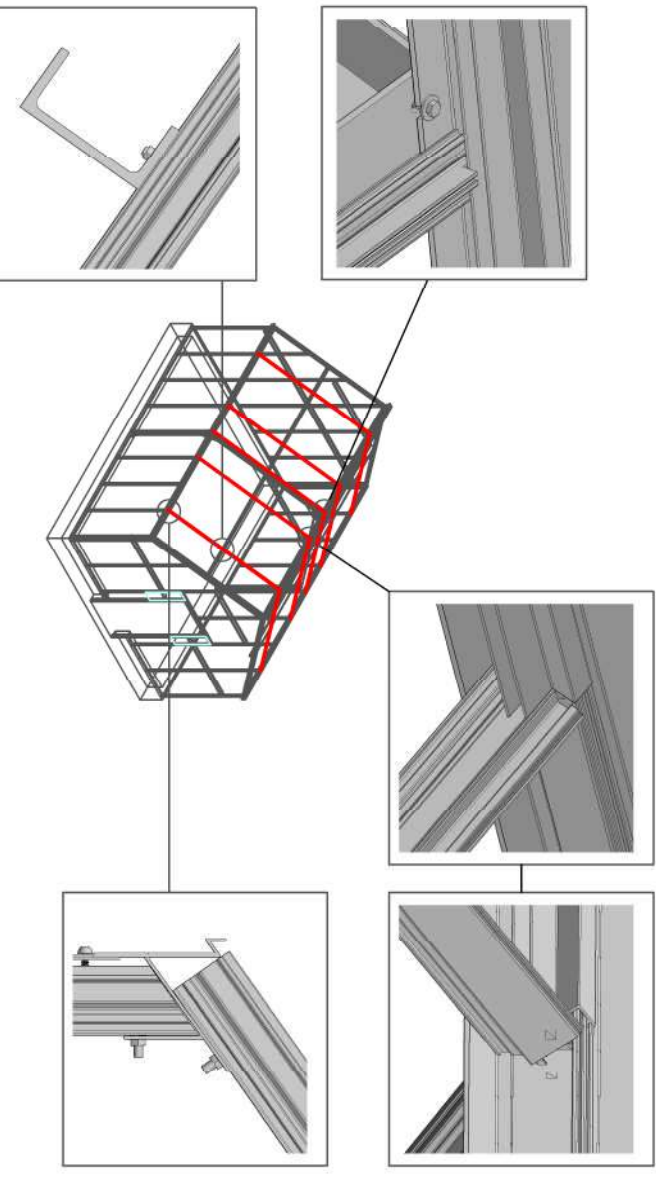
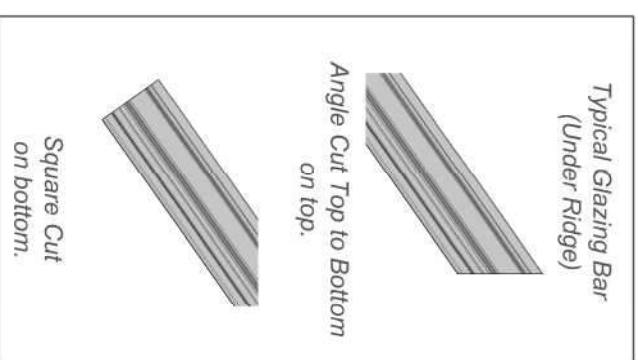
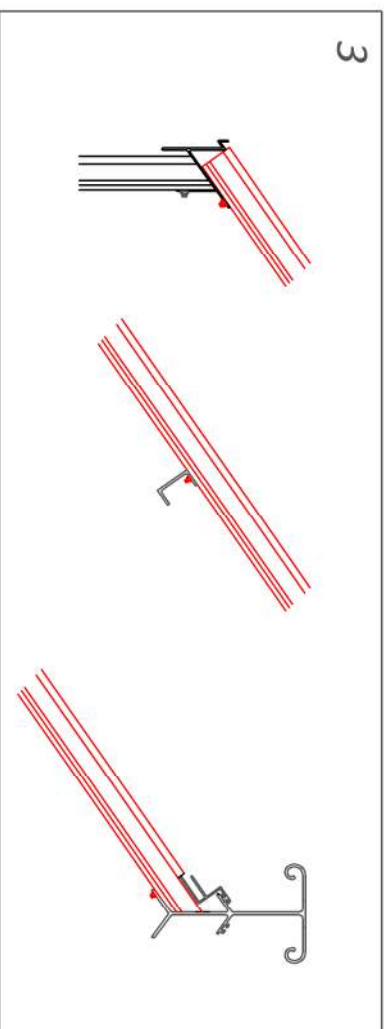
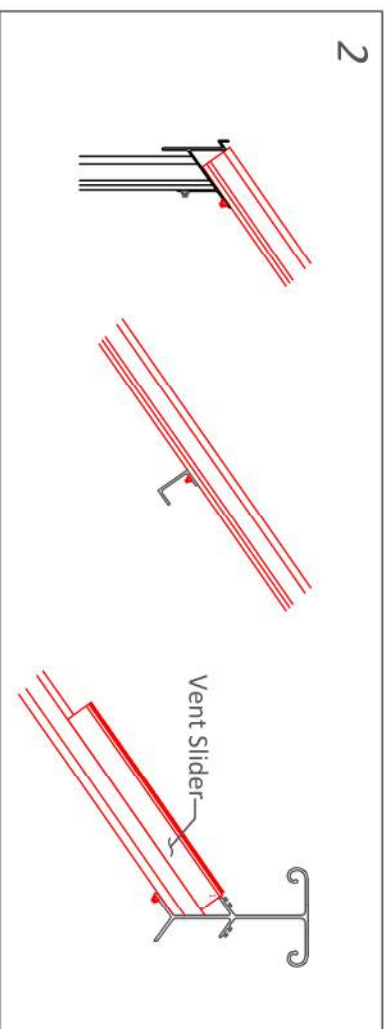
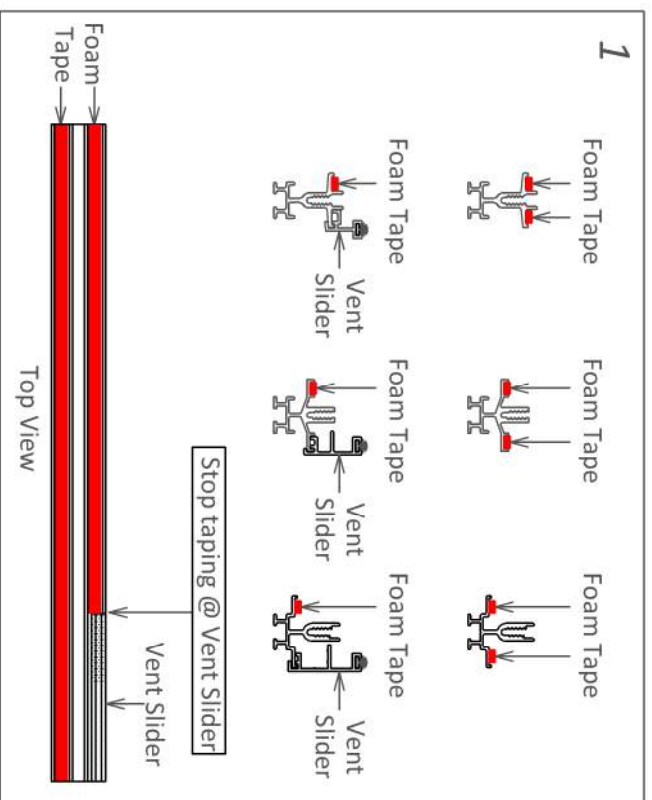



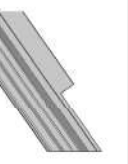

REPEAT FOR ALL REMAINING GLAZING BARS THAT CONNECT TO RIDGE.

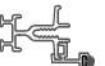

On Greenhouses with 6mm or 16mm Glazing in the roof, the Roof Glazing Bars that fasten to the Ridge and do not have Vent Sliders attached will have a notch cut out of the top end.



**Parts List:**

-   
 Glazing Bar  
 (3mm Single Glass)
-   
 Glazing Bar w/Slider  
 (3mm Single Glass)
-   
 Glazing Bar  
 (6mm Twinwall Poly.)
-   
 Glazing Bar w/Slider  
 (6mm Single Glass)
-   
 Glazing Bar w/Slider  
 (6mm )
-   
 Glazing Bar  
 (16mm Firewall Poly.)
-   
 Glazing Bar  
 (16mm Double Glass)
-   
 Glazing Bar w/Slider  
 (16mm )
-   
 Foam Tape  
 1/4" x 1/2" S.S. Bolts & Nuts



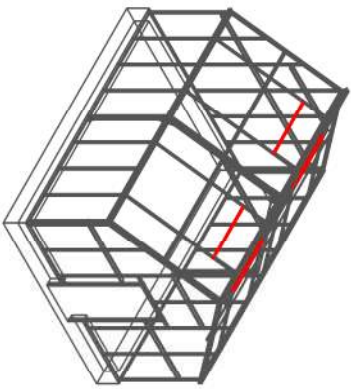



**STAGE 13: VENT FRAME BOTTOMS**

**STEPS:**

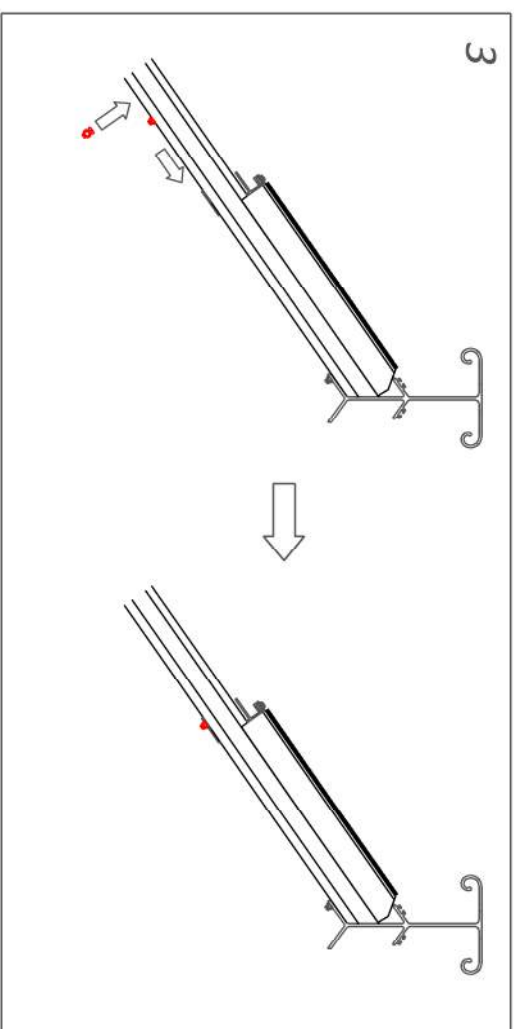
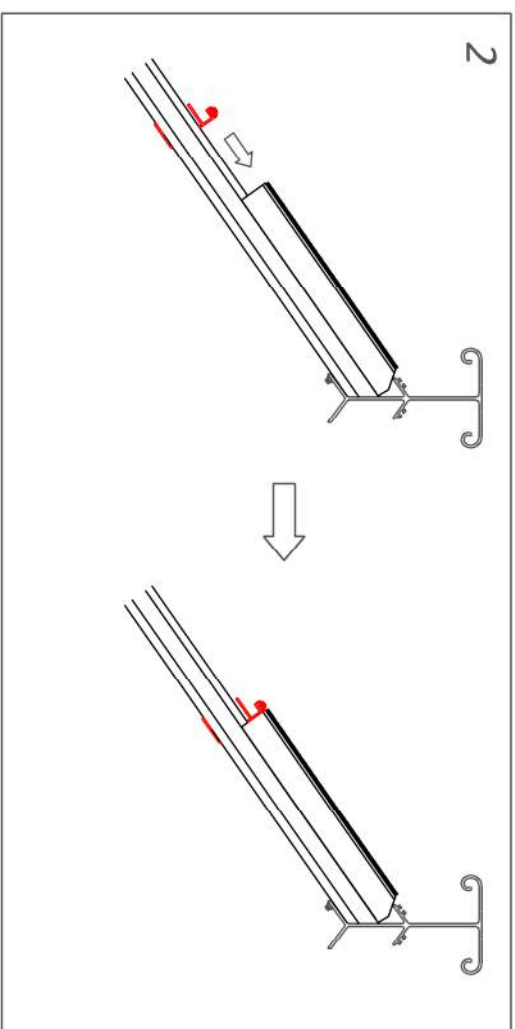
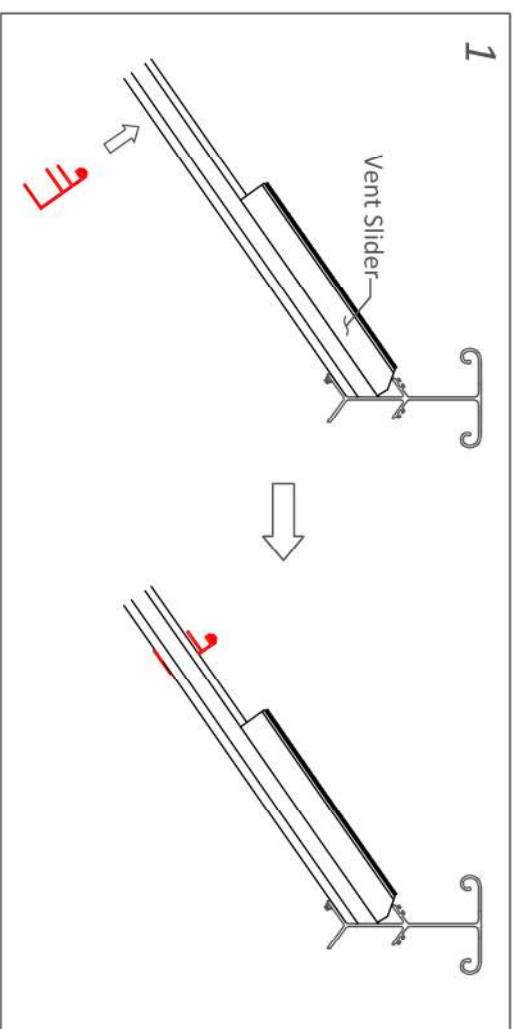
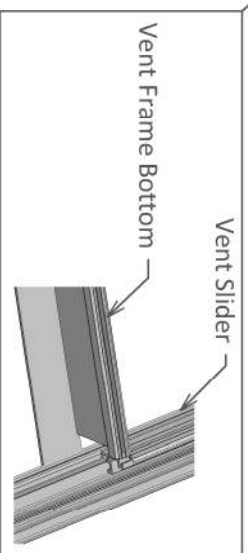
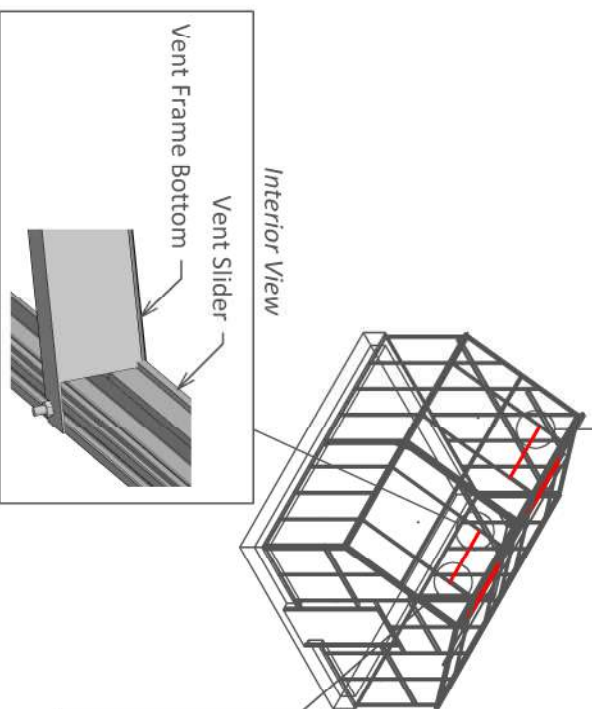
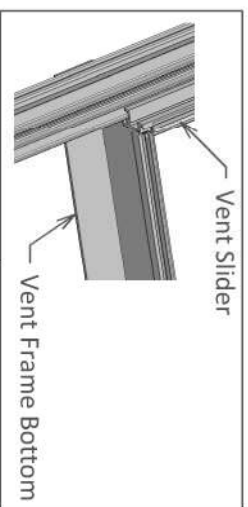
1. FIT THE VENT FRAME BOTTOM BETWEEN THE ROOF GLAZING BARS WHICH HAVE VENT SLIDERS ATTACHED.
2. SLIDE THE VENT FRAME BOTTOM TOWARDS THE RIDGE UNTIL IT IS TIGHT TO THE VENT SLIDERS.
3. SECURE THE VENT FRAME BOTTOM TO THE GLAZING BARS.





**Parts List:**

- 

Vent Frame Bottom  
(3mm Single Glass)
- 

Vent Frame Bottom  
(6mm Twinwall Poly.)
- 

Vent Frame Bottom  
(6mm Single Glass)
- 

Vent Frame Bottom  
(16mm Fivewall Poly.)
- 

Vent Frame Bottom  
(16mm Double Glass)

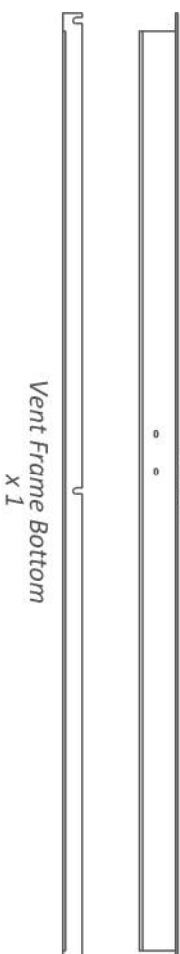

Top View

Vent Frame Bottom  
x 1

- 

$\frac{1}{4}$ " x  $\frac{1}{2}$ " S.S. Bolts & Nuts



**PRO TIPS**

Vent Sliders should be tight to the Ridge once the Vent Frame Bottoms have been installed.

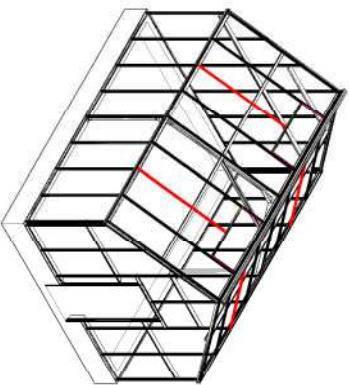

**STAGE 14: ROOF GLAZING BARS - UNDER VENT**

- STEPS:**
1. APPLY FOAM TAPE TO ALL GLAZING BARS.
  2. ATTACH GLAZING BAR TO VENT FRAME BOTTOM, PURLIN & GUTTER.
- REPEAT FOR ALL REMAINING GLAZING BARS.

**IF YOUR GREENHOUSE HAS SIDE WALL DIAGONAL BRACES, INSTALL THEM NOW BEFORE STARTING ON THE GLAZING INSTALLATION. REFER TO PAGE ACC 7-8 AT THE BACK OF THIS MANUAL IF APPLICABLE.**

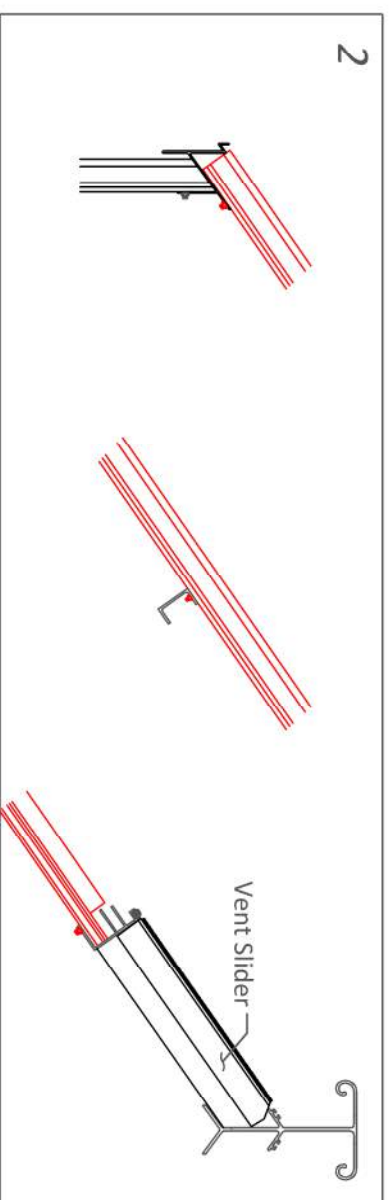
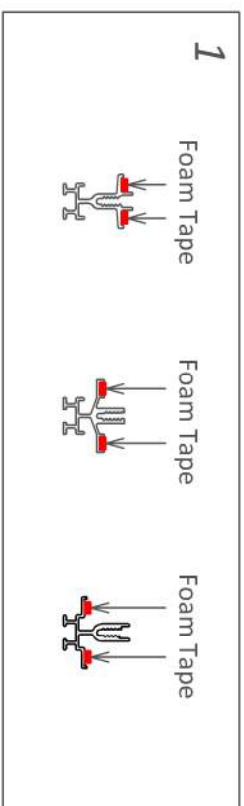
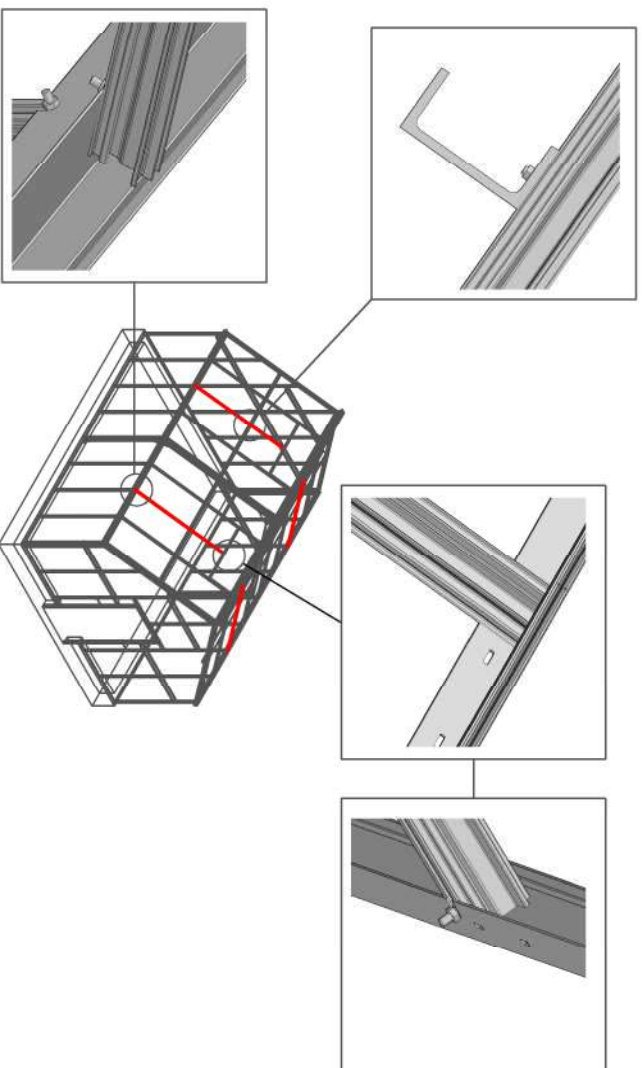

**PRO TIPS**

Smile. You never know who's watching.

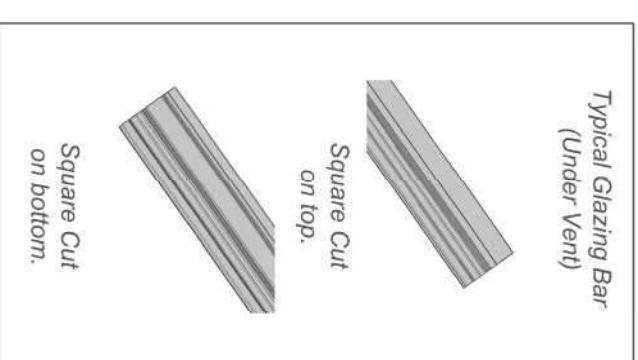

On Greenhouses with 6mm Glazing in the roof, the Roof Glazing Bars below the Roof Vent will have a notch cut out of the top end.

**Parts List:**

- Glazing Bar  
(3mm Single Glass)
- Glazing Bar  
(6mm Twinwall Poly.)
- Glazing Bar  
(6mm Single Glass)
- Glazing Bar  
(16mm Fivewall Poly.)
- Glazing Bar  
(16mm Double Glass)
- Foam Tape
- ¼" x ½" S.S. Bolts & Nuts

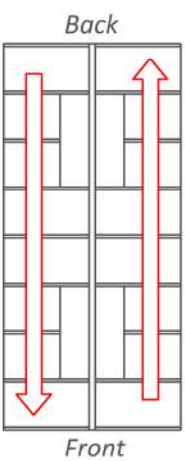
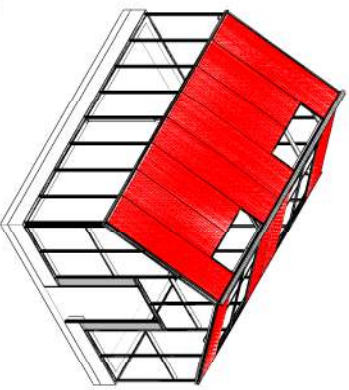

GLAZE & CAP THE ROOF IN ORDER FROM BACK TO FRONT AND THEN FRONT TO BACK. COMPLETE ONE SIDE BEFORE BEGINNING THE NEXT.

**STAGE 15A: ROOF GLAZING - (6MM TWINWALL POLYCARBONATE)**

- STEPS:**
1. PEEL THE BROWN PAPER FROM THE FOAM TAPE ON THE ROOF GLAZING BARS.
  2. MARK ONE OUTSIDE CORNER OF THE POLYCARBONATE PANELS WITH A FELT PEN.
  3. PEEL THE FILM OFF BOTH SIDES OF THE POLYCARBONATE PANEL.
  4. PLACE THE H-CHANNEL ONTO THE BOTTOM OF A POLYCARBONATE PANEL.
- CONTINUE ON NEXT PAGE

*If using a cordless drill to fasten the Caps, set your drill to a low Torque Setting. Screws should be snug to the cap plus a quarter turn.*

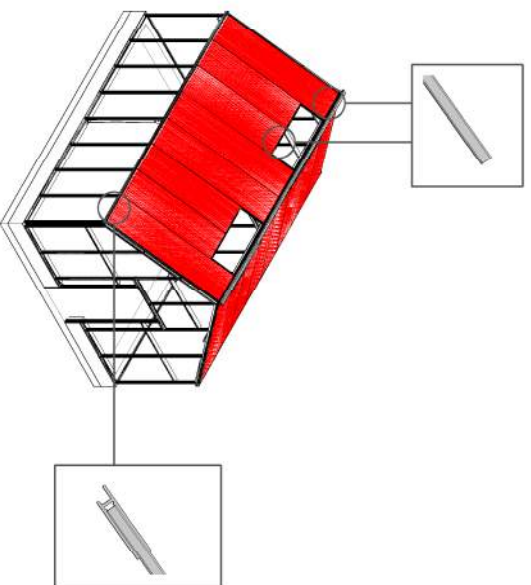

**Parts List:**

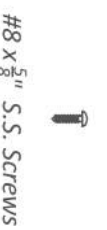
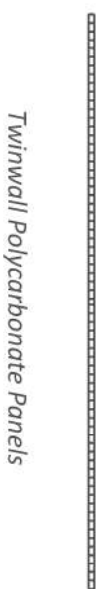

**1**

Peel paper from Foam Tape

**2**

Outside (blue film)

**3**

**4**

Inside Outside

**PRO TIPS**

Have one person working outside the greenhouse and one on the inside to help fit the polycarbonate panels into the Ridge.

Typical Polycarbonate (Roof)

Square Cut on top.

Square Cut on bottom.

**\*WARNINGS\***

- DO NOT STORE POLYCARBONATE PANELS IN DIRECT SUNLIGHT- The Plastic Film can melt onto the panels if they get too hot.

-DO NOT LAY POLYCARBONATE PANELS DIRECTLY ON THE GRASS- Doing so can burn / kill the grass

Due to circumstances beyond our control, the polycarbonate may not have Blue Film identifying the outside surface. In this situation, the outside surface will be identified with Text.

On hot days, you may find that the Glazing Foam is too sticky. Spraying the foam with a light soapy water will make installing the Polycarbonate easier.

Polycarbonate Panels, Glazing Caps & h-Channels will come packaged specific to their location in the greenhouse. Open the Bundles only as you need them.

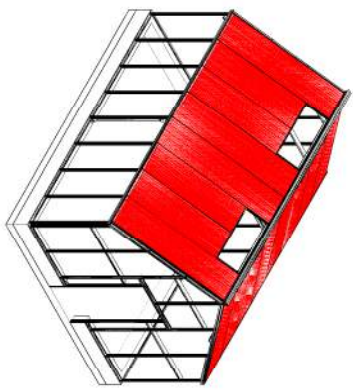

**STAGE 15B: ROOF GLAZING -  
(6MM TWINWALL POLYCARBONATE)**

**STEPS:**

- 5. INSERT THE TOP OF THE POLYCARBONATE PANEL INTO THE RIDGE.
  - 6. INSERT THE H-CHANNEL AT THE BOTTOM OF THE PANEL INTO THE GUTTER.
- REPEAT

- 7. INSERT THE TOP OF THE POLYCARBONATE PANEL INTO THE VENT FRAME BOTTOM.
  - 8. REPEAT STEP 6.
- REPEAT

CONTINUE ON NEXT PAGE

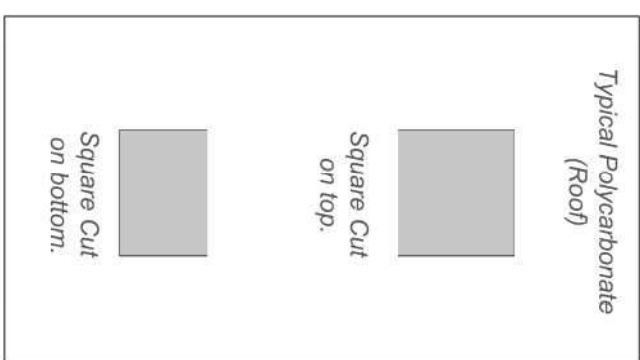
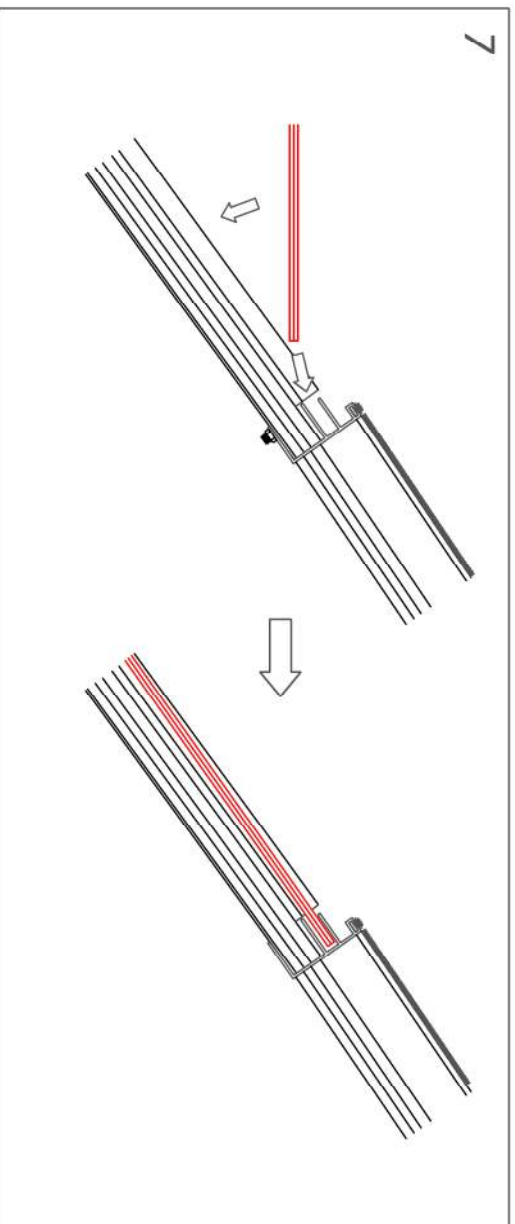
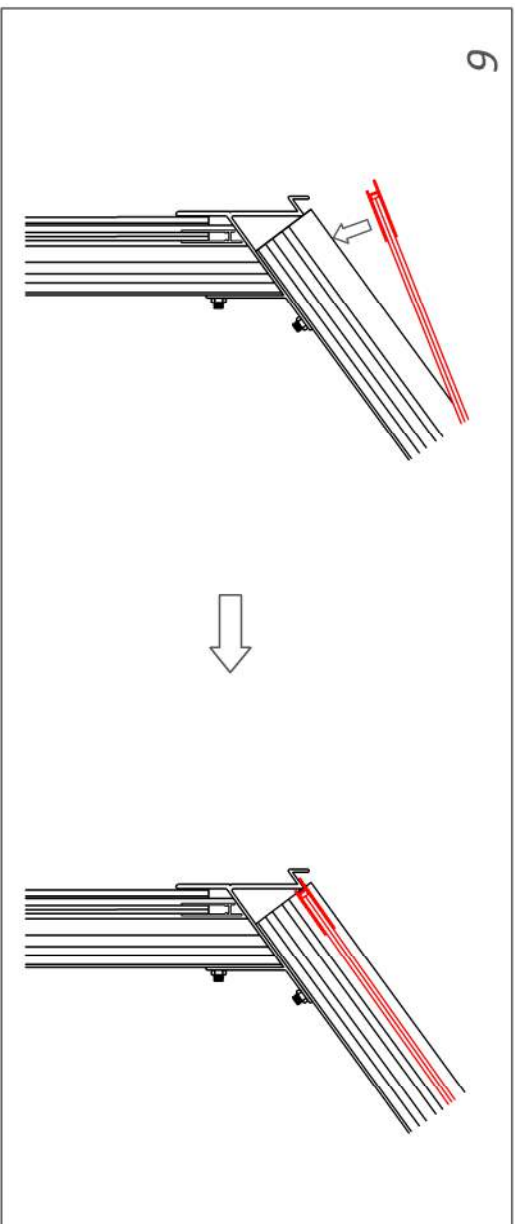
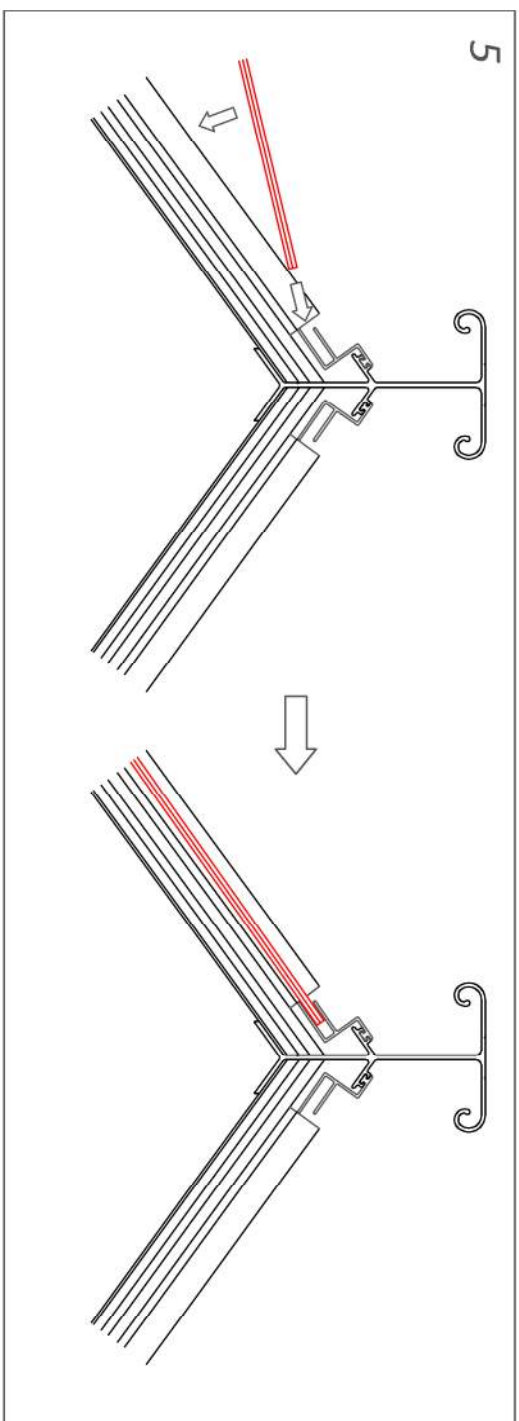
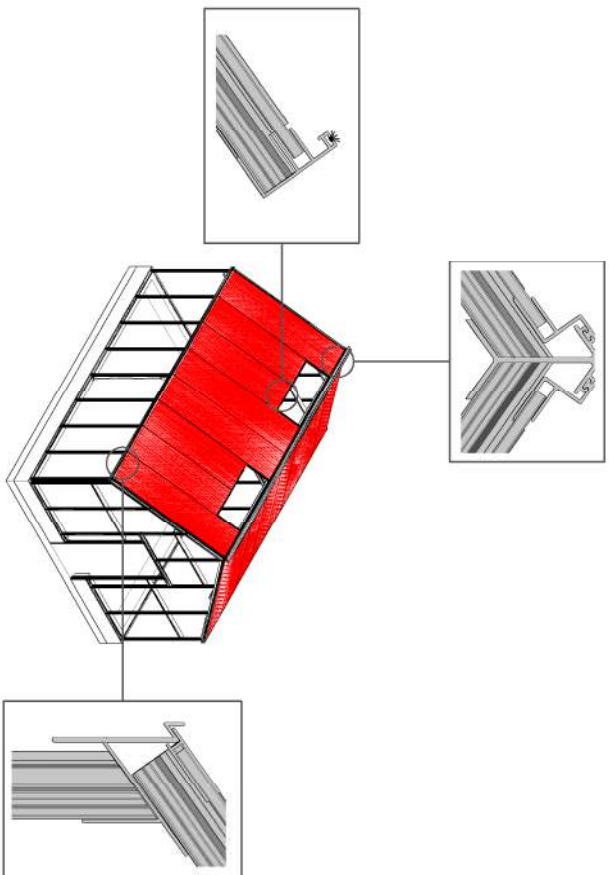

**PRO TIPS**



Have one person working outside the greenhouse and one on the inside to help fit the polycarbonate panels into the Ridge.

**Parts List:**



Glazing Caps



Glazing Caps (Ripped)



h-Channels



Twinwall Polycarbonate Panels



#8 x 5/8" S.S. Screws



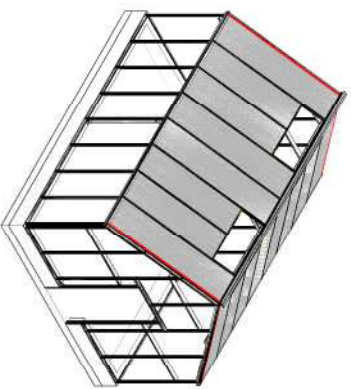

**STAGE 15C: ROOF END CAPS-  
(6MM TWINWALL POLYCARBONATE)**

- STEPS:**
9. LAY THE RIPPED CAP ON THE END GLAZING BAR AND TUCK BENEATH THE END RAFTER.(CAP SHOULD SIT TIGHT TO THE GUTTER)
  10. SECURE THE CAP TO THE GLAZING BAR.
- REPEAT FOR ALL CORNERS  
CONTINUE ON NEXT PAGE

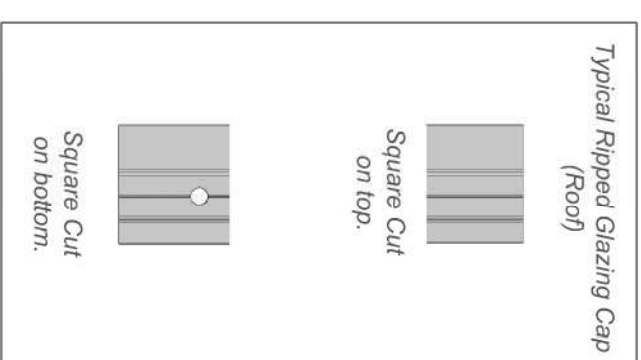
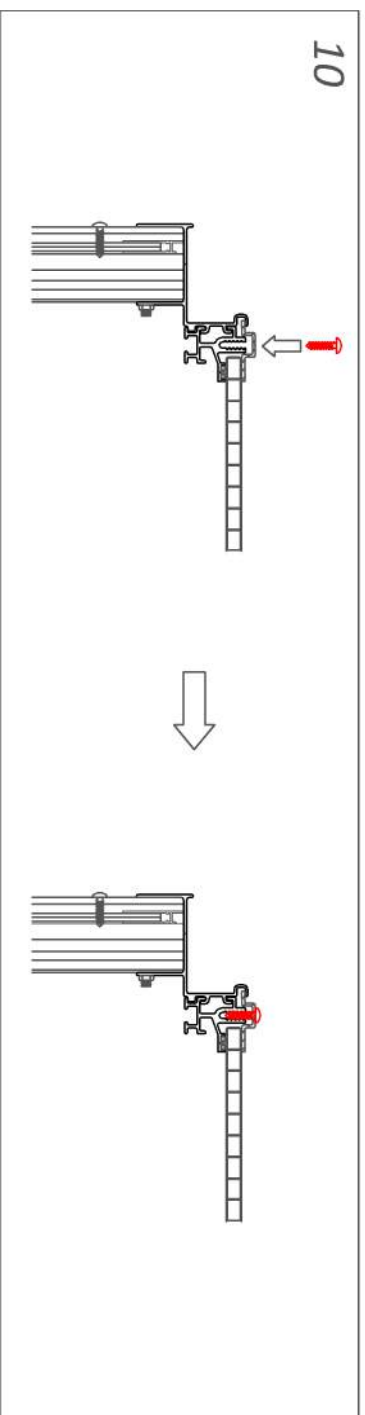
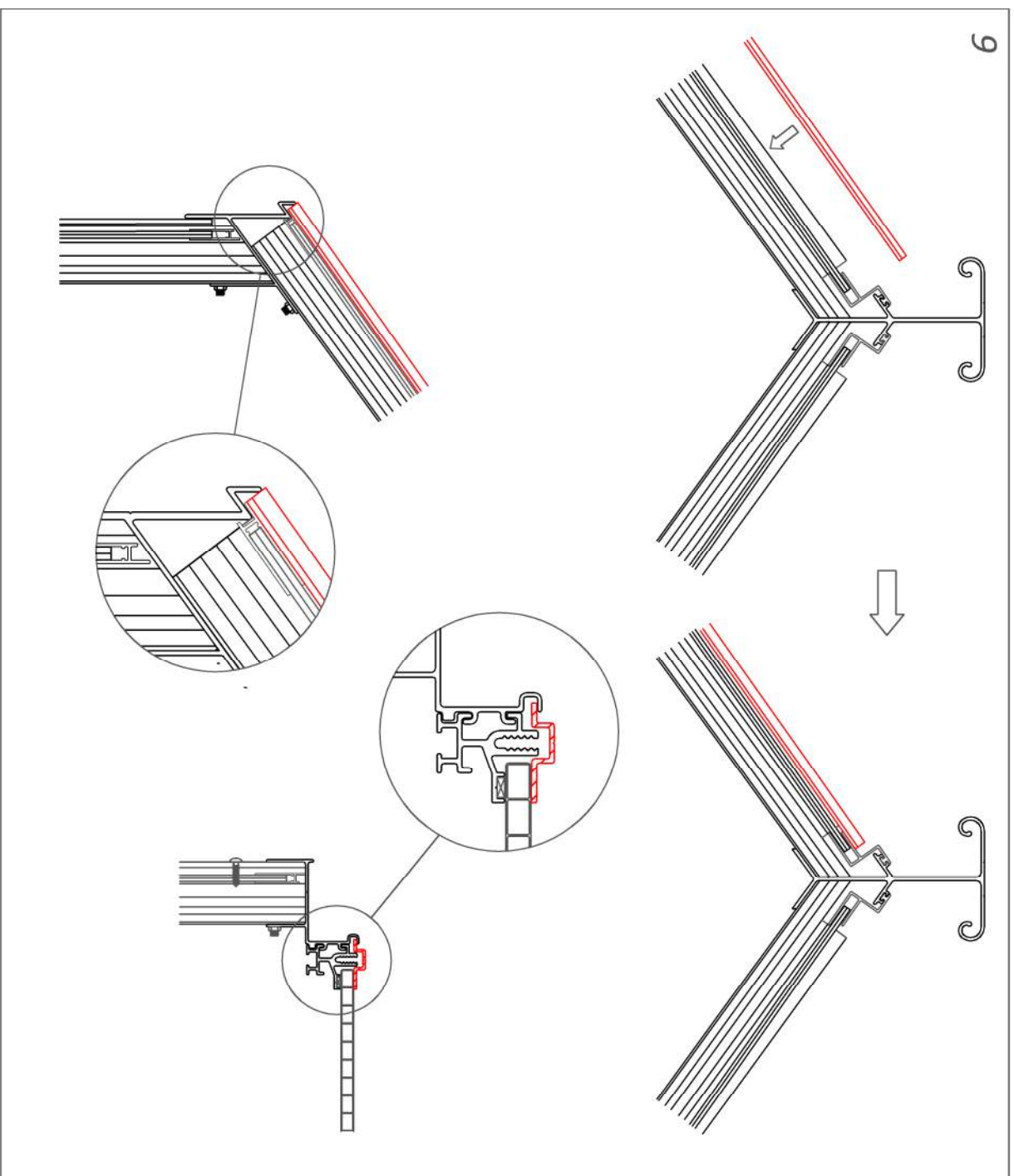
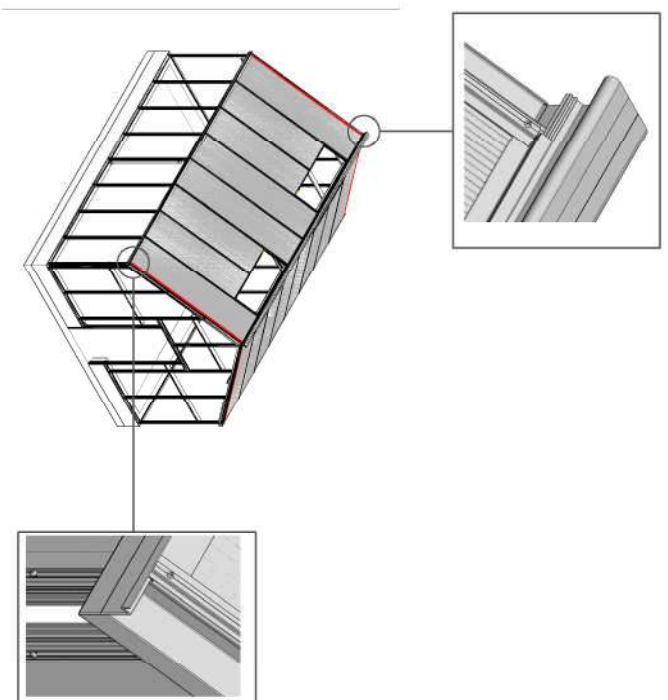

**Parts List:**



Glazing Caps



Glazing Caps (Ripped)



h-Channels



Twinwall Polycarbonate Panels



#8 x  $\frac{5}{8}$ " S.S. Screws



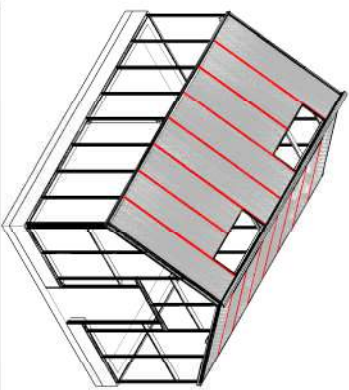

**STAGE 15D: ROOF GLAZING -  
(6MM TWINWALL POLYCARBONATE)**

- STEPS:**  
 11. LAY THE CAP ON THE GLAZING BAR (CAP SHOULD SIT TIGHT TO THE GUTTER)  
 12. SECURE THE CAP TO THE GLAZING BAR.  
 REPEAT FOR ALL REMAINING ROOF CAPS

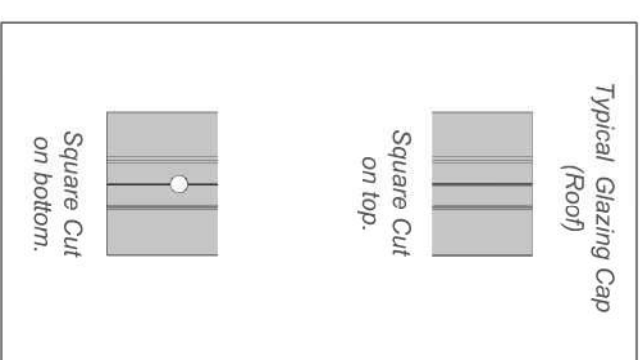
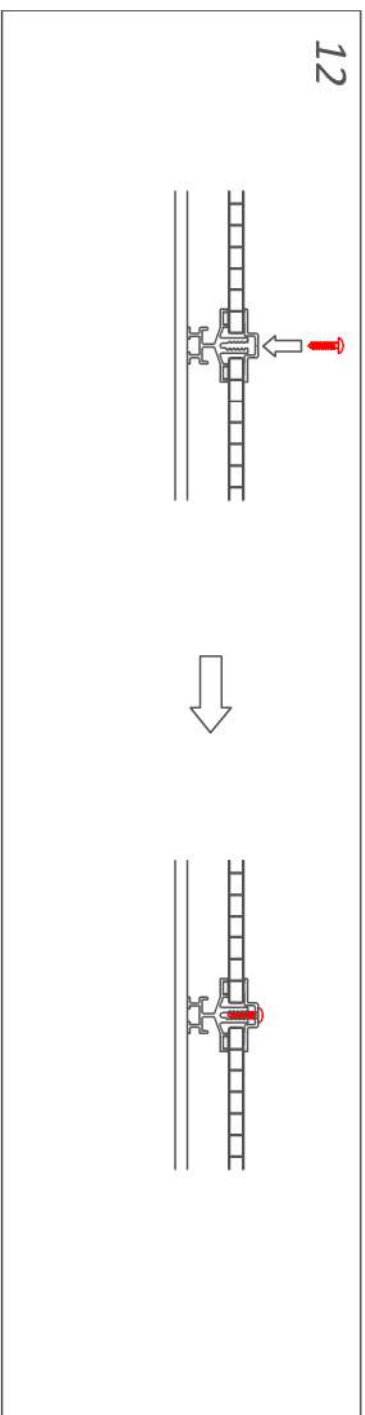
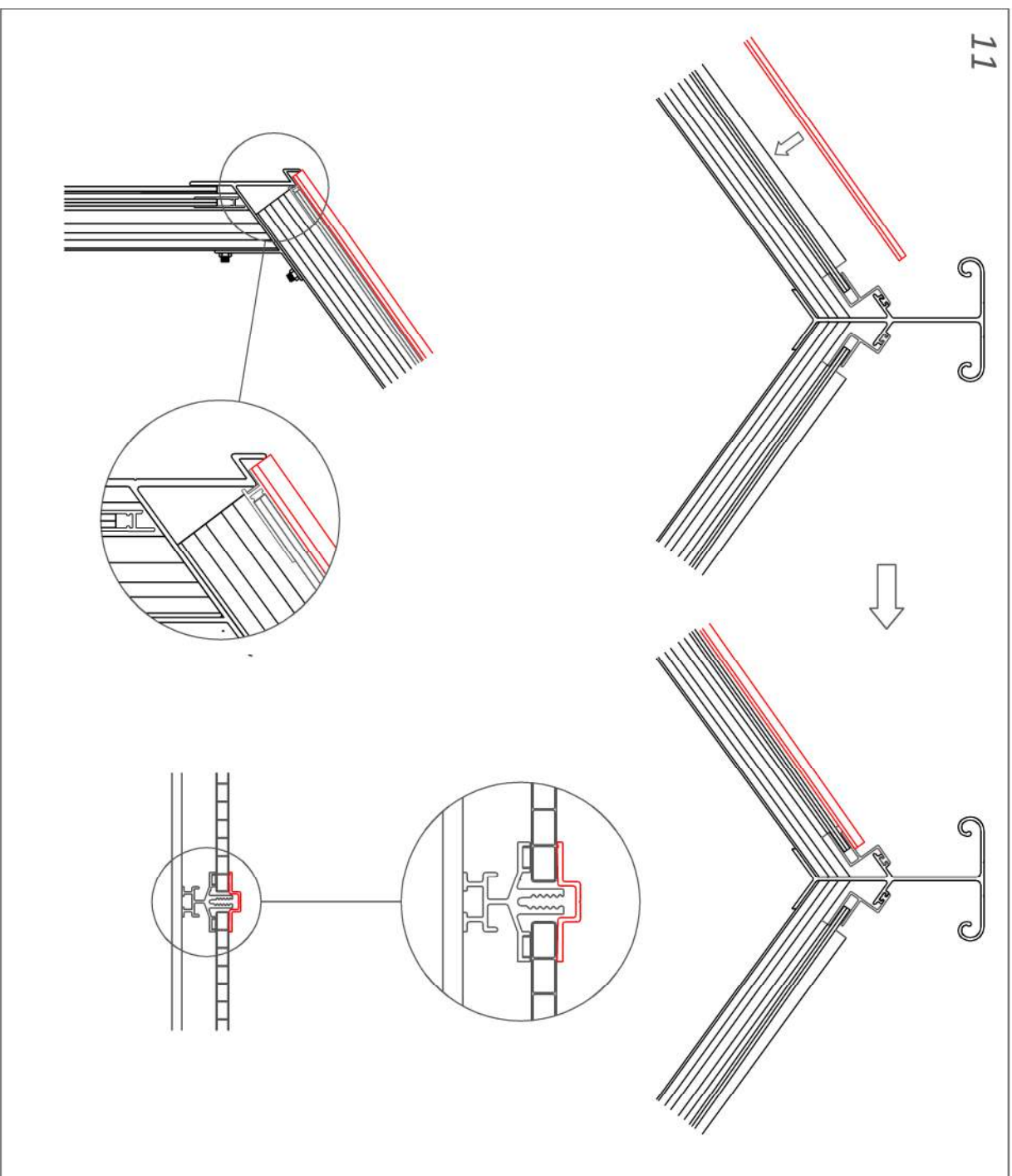
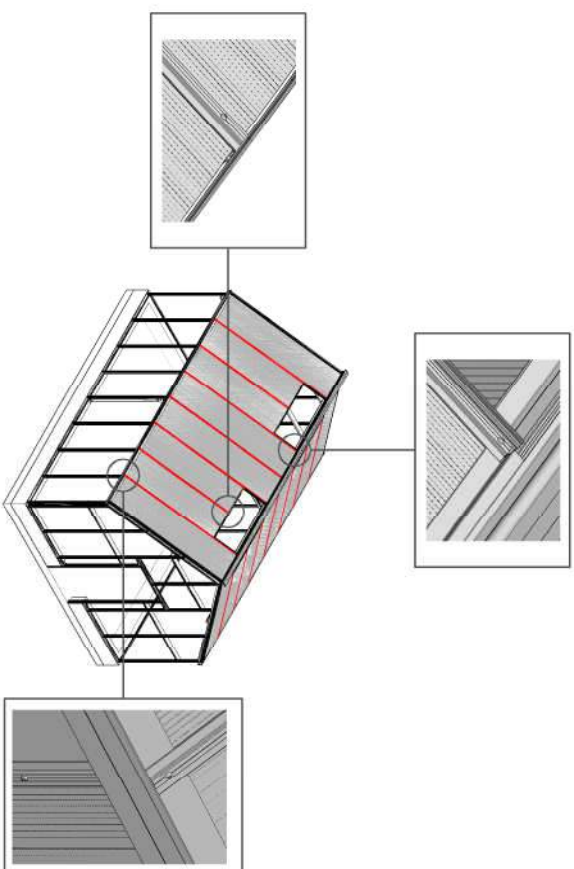

**Parts List:**



Glazing Caps



Glazing Caps (Ripped)



h-Channels



Twinwall Polycarbonate Panels



#8 x 5/8" S.S. Screws

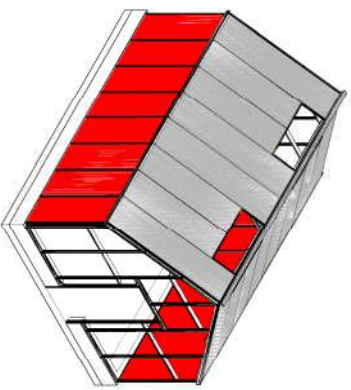

**STAGE 16A: SIDE WALL GLAZING - (6MM TWINWALL POLYCARBONATE)**

- STEPS:**
1. PEEL THE BROWN PAPER FROM THE FOAM TAPE ON THE SIDE WALL GLAZING BARS.
  2. MARK ONE OUTSIDE CORNER OF THE POLYCARBONATE PANEL WITH A FELT PEN.
  3. PEEL THE FILM OFF BOTH SIDES OF THE POLYCARBONATE PANEL.
  4. PLACE THE H-CHANNEL ON THE TOP & BOTTOM OF A POLYCARBONATE PANEL.
- CONTINUE ON NEXT PAGE

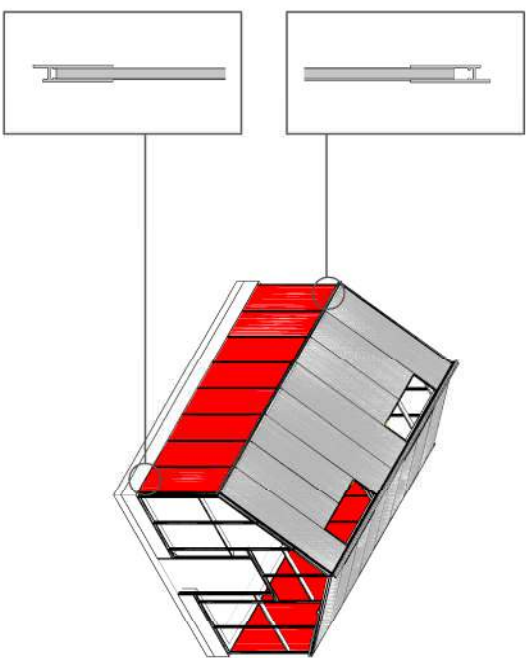

**Parts List:**



Glazing Caps



Glazing Caps (Ripped)



h-Channels



Twinwall Polycarbonate Panels



#8 x 5/8" S.S. Screws

**1**

Peel paper from Foam Tape

**2**

Outside (blue film)

**3**

**4**

Inside Outside

**PRO TIPS**

Marking the top outside corner of the polycarbonate panel will help you to identify the outside surface once the film is peeled..

Typical Polycarbonate (Side Wall)

Square Cut on top.

Square Cut on bottom.

**\*WARNINGS\***

**- DO NOT STORE POLYCARBONATE PANELS IN DIRECT SUNLIGHT-**  
The Plastic Film can melt onto the panels if they get too hot.

**-DO NOT LAY POLYCARBONATE PANELS DIRECTLY ON THE GRASS-**  
Doing so can burn / kill the grass

Due to circumstances beyond our control, the polycarbonate may not have Blue Film identifying the outside surface. In this situation, the outside surface will be identified with Text.

On hot days, you may find that the Glazing Foam is too sticky. Spraying the foam with a light soapy water will make installing the Polycarbonate easier.

Polycarbonate Panels, Glazing Caps & h-Channels will come packaged specific to their location in the greenhouse. Open the Bundles only as you need them.

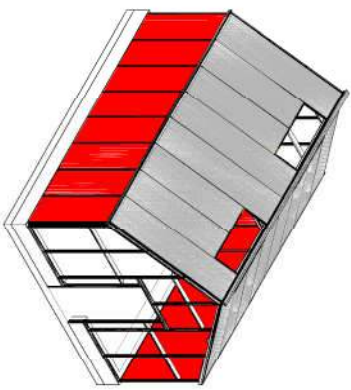

**STAGE 16B: SIDE WALL GLAZING -  
(6MM TWINWALL POLYCARBONATE)**

**STEPS:**

5. SLIP THE TOP OF THE POLYCARBONATE PANEL BENEATH THE GUTTER.
6. PUSH THE BOTTOM OF THE POLYCARBONATE PANEL INTO POSITION.
7. PUSH THE TOP H-CHANNEL UP UNTIL IT TOUCHES THE UNDERSIDE OF THE GUTTER.

REPEAT FOR ALL SIDE WALL GLAZING

CONTINUE ON NEXT PAGE

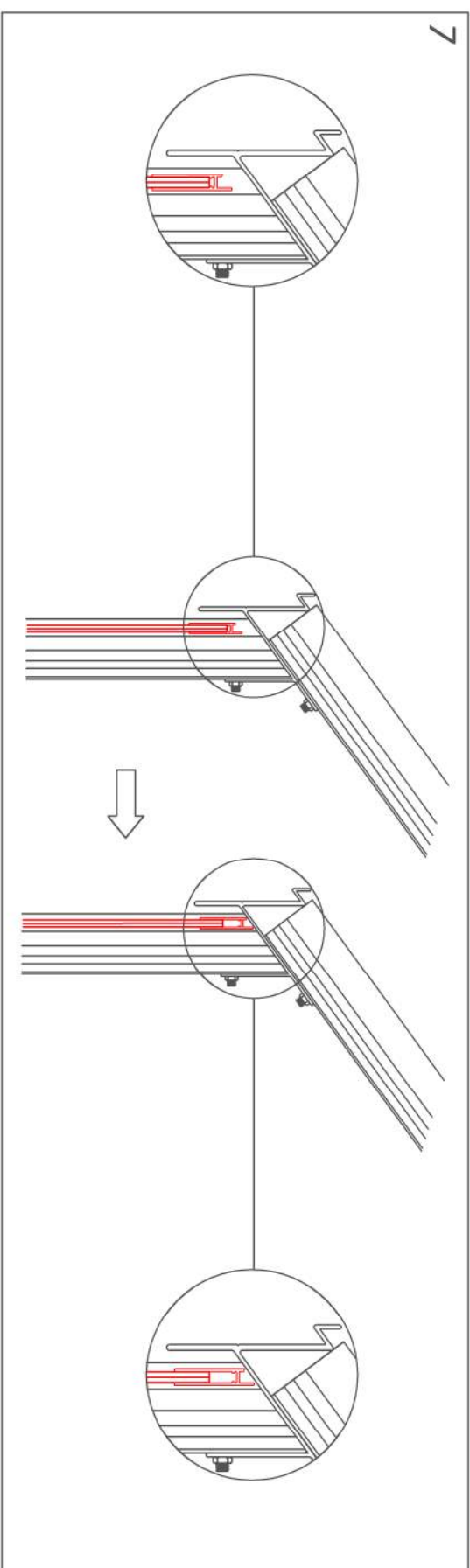
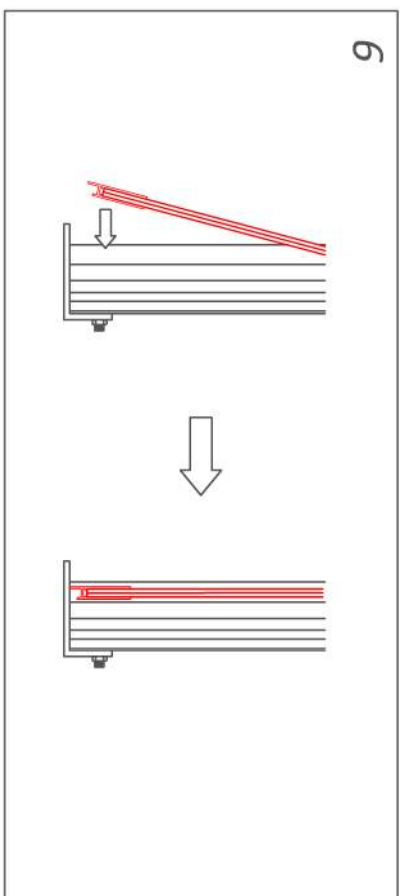
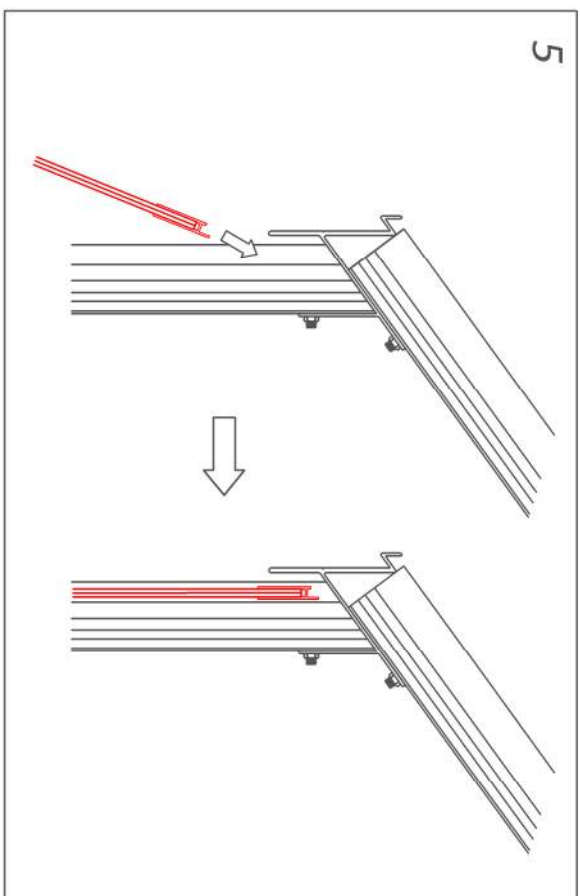
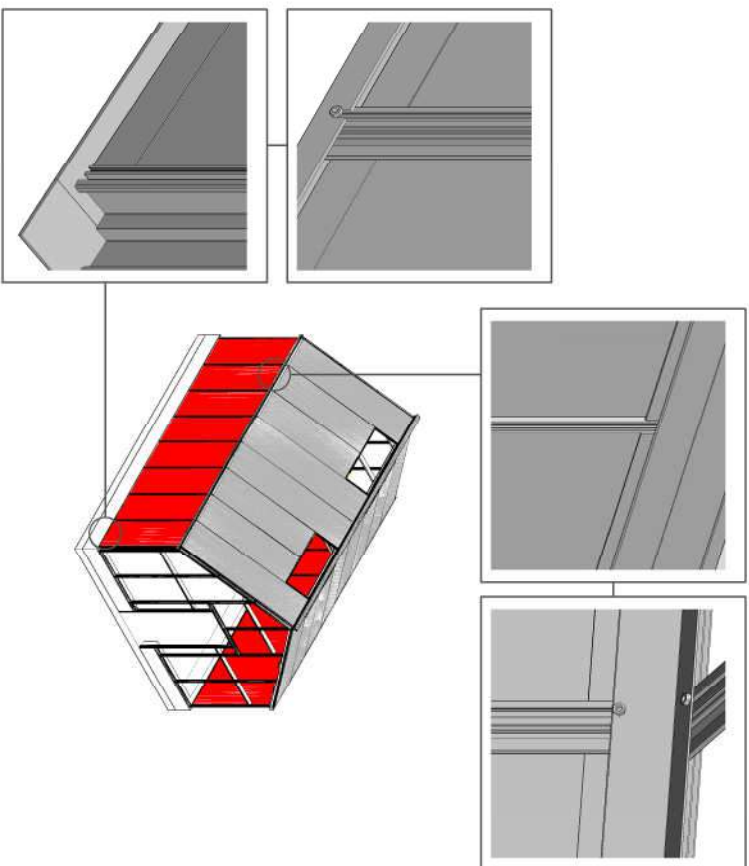

**PRO TIPS**



Start by glazing the 4 corners on the side walls of the greenhouse. This will help to square the frame from front to back. Don't be afraid to shift the Frame as necessary.

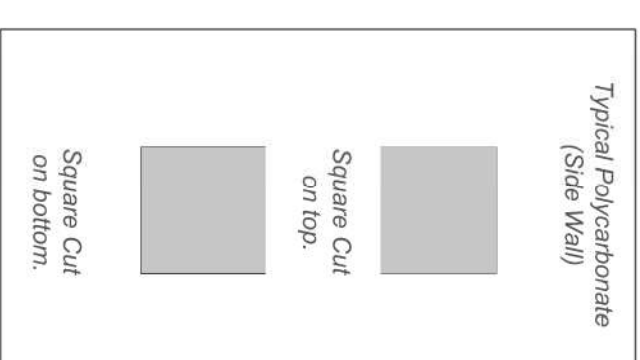

**Parts List:**



Glazing Caps



Ripped Glazing Caps



h-Channels



Twinwall Polycarbonate Panels



#8 x 5/8" S.S. Screws

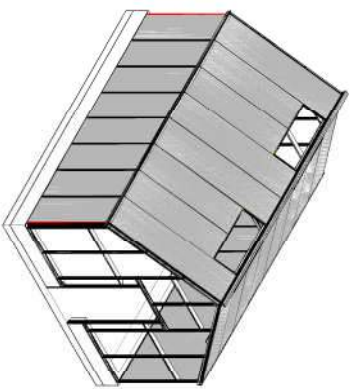

### STAGE 16C: SIDE WALL CORNER CAPS - (6MM TWINWALL POLYCARBONATE)

**STEPS:**

- 8. TUCK THE TOP OF THE RIPPED CAP BENEATH THE GUTTER AND INSIDE THE CORNER POST.
- 9. SECURE THE CAP TO THE GLAZING BAR.

REPEAT FOR ALL CORNERS

CONTINUE ON NEXT PAGE

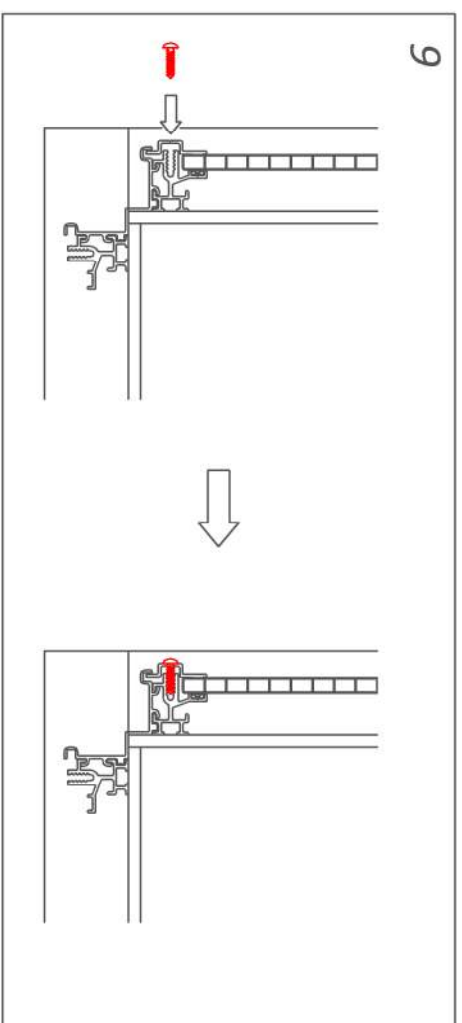
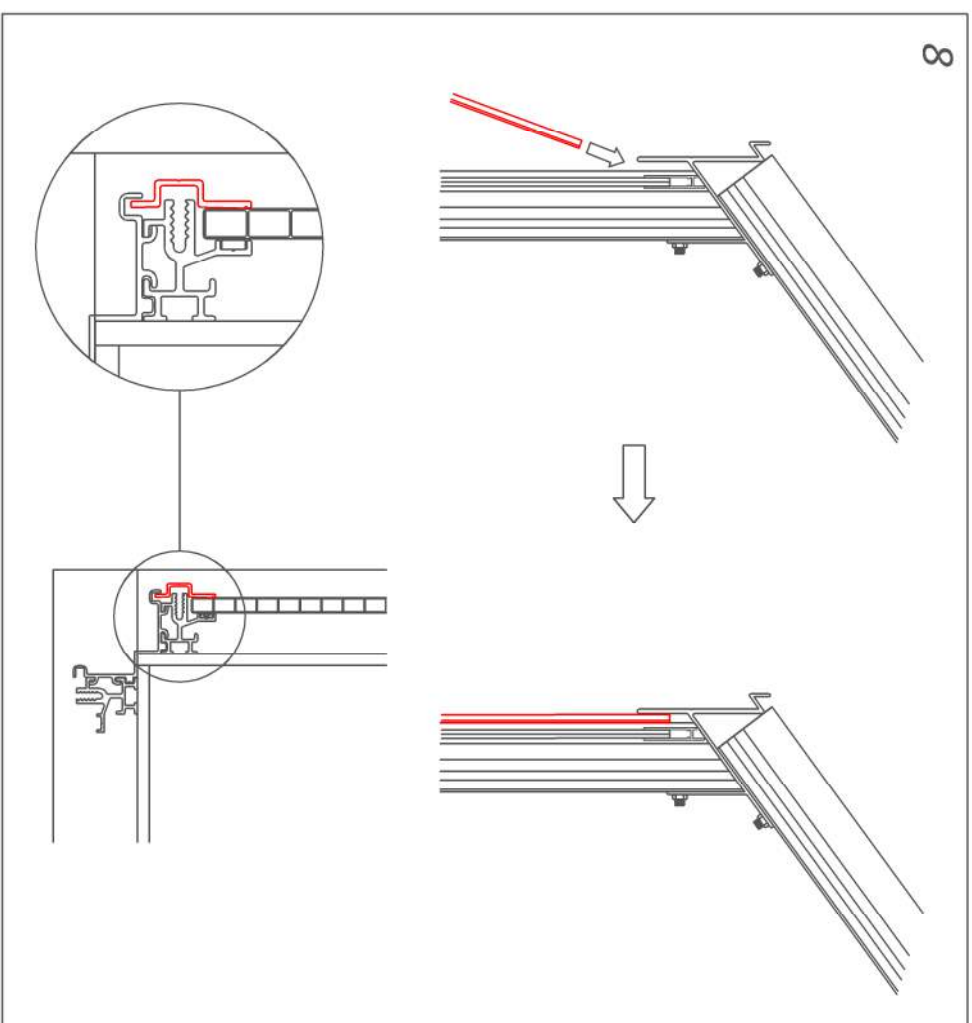
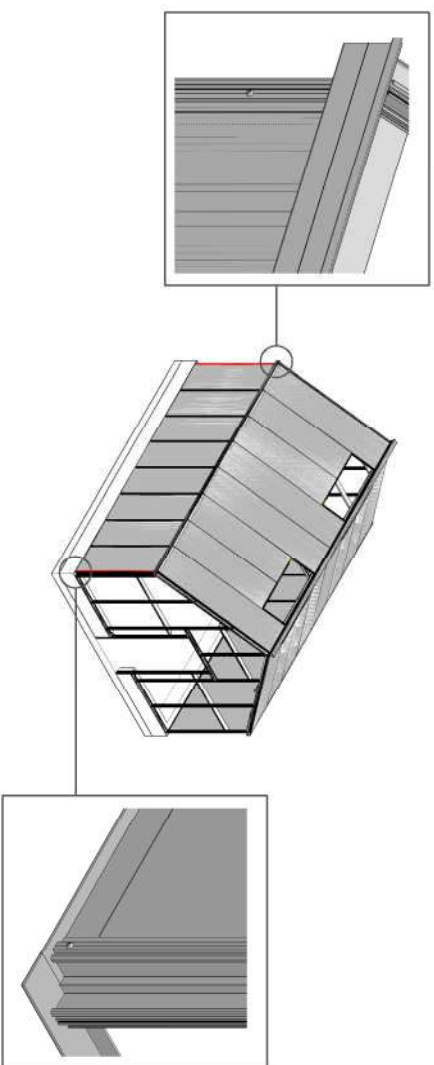

### PRO TIPS

All Glazing Caps are cut and punched so that the holes will line up horizontally if installed right side up.

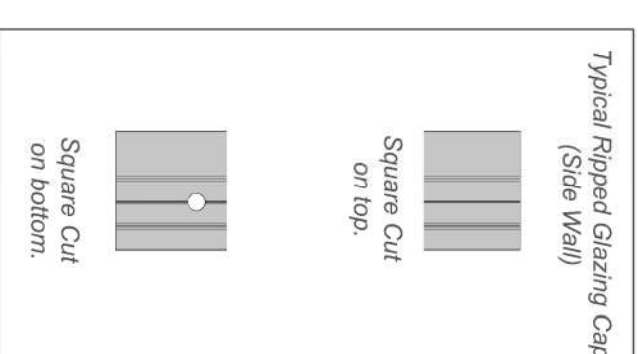

**Parts List:**



Glazing Caps



Ripped Glazing Caps



h-Channels



Twinwall Polycarbonate Panels



#8 x 5/8" S.S. Screws

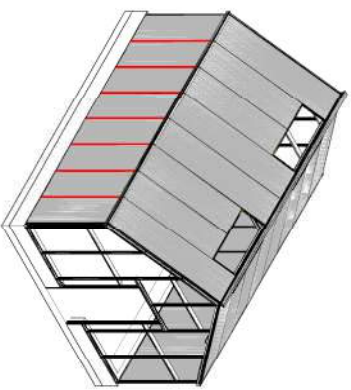

**STAGE 16D: SIDE WALL CAPS -  
(6MM TWINWALL POLYCARBONATE)**

**STEPS:**

10. TUCK THE TOP OF THE CAP BENEATH THE GUTTER.
  11. SECURE THE CAP TO THE GLAZING BAR.
- REPEAT FOR ALL REMAINING CAPS

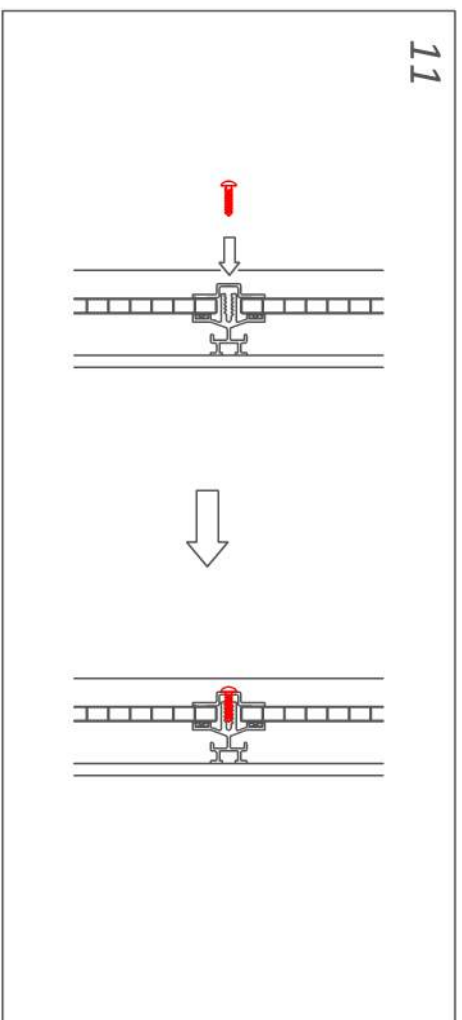
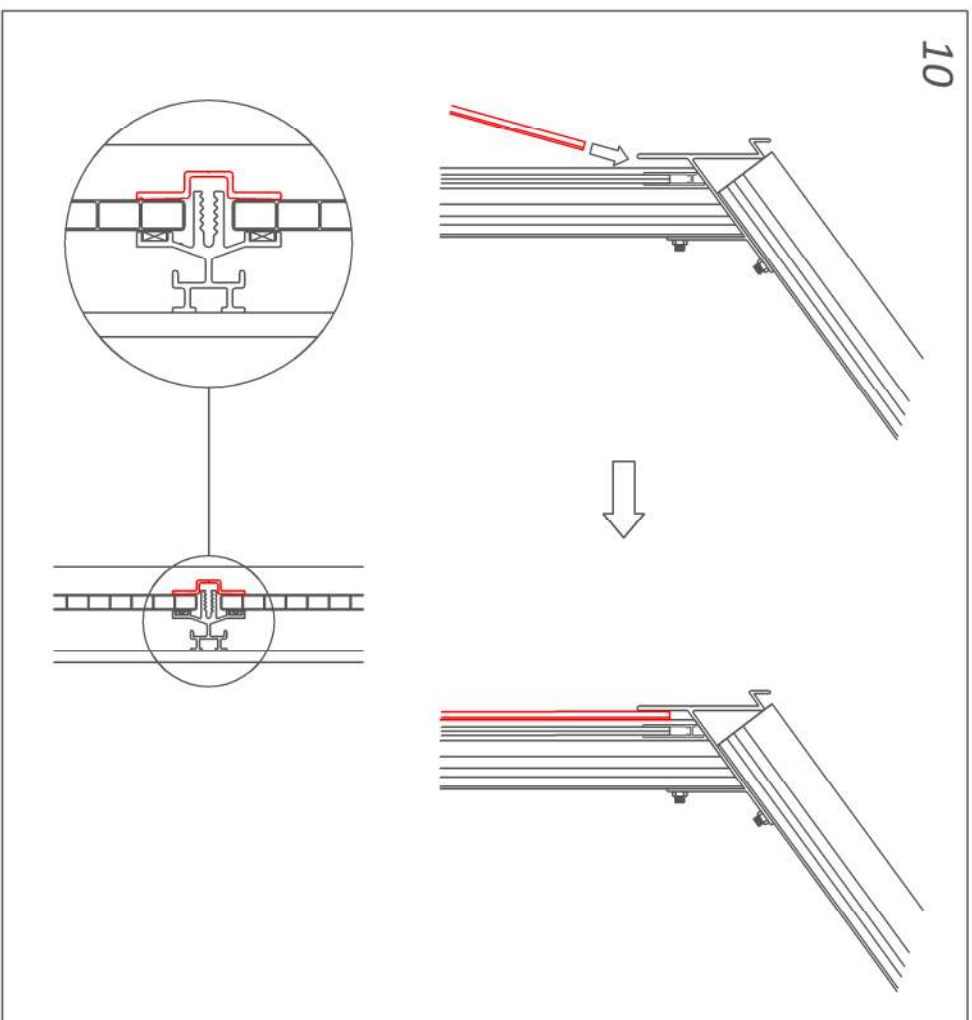
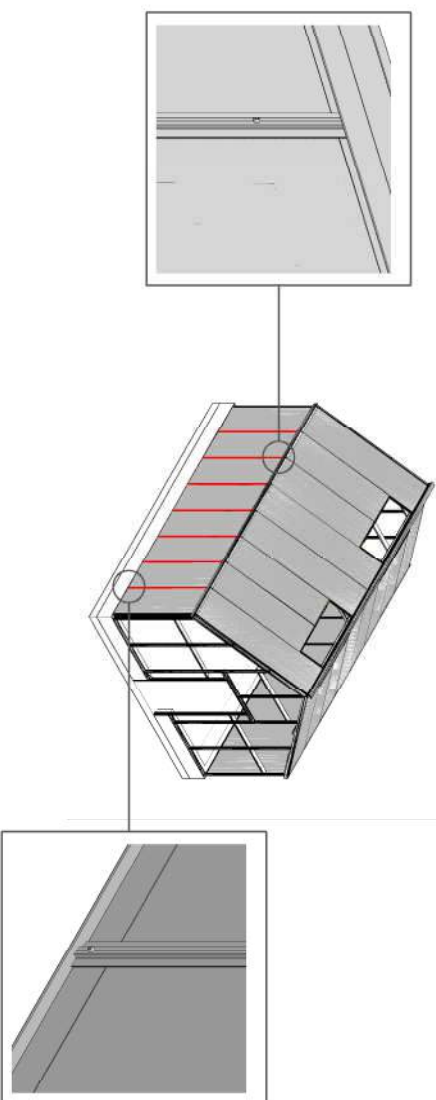

**PRO TIPS**

All Side Wall Caps should sit flush on top of the Base and be tucked underneath the gutter.

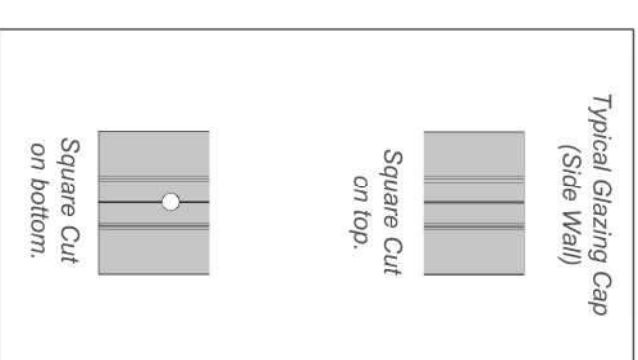

**Parts List:**



Glazing Caps



Ripped Glazing Caps



h-Channels



Twinwall Polycarbonate Panels



#8 x 5/8" S.S. Screws

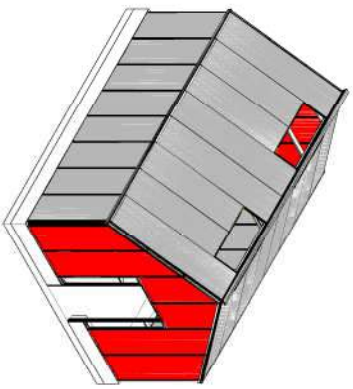

**STAGE 17A: GABLE GLAZING -  
(6MM TWINWALL POLYCARBONATE)**

- STEPS:**
1. PEEB THE BROWN PAPER FROM THE FOAM TAPE ON THE GABLE WALL GLAZING BARS .
  2. MARK ONE OUTSIDE CORNER OF THE POLYCARBONATE PANEL WITH A FELT PEN.
  3. PEEB THE FILM OFF BOTH SIDES OF THE POLYCARBONATE PANEL.
  4. PLACE THE H-CHANNEL ON THE TOP & BOTTOM OF A POLYCARBONATE PANEL
- CONTINUE ON NEXT PAGE

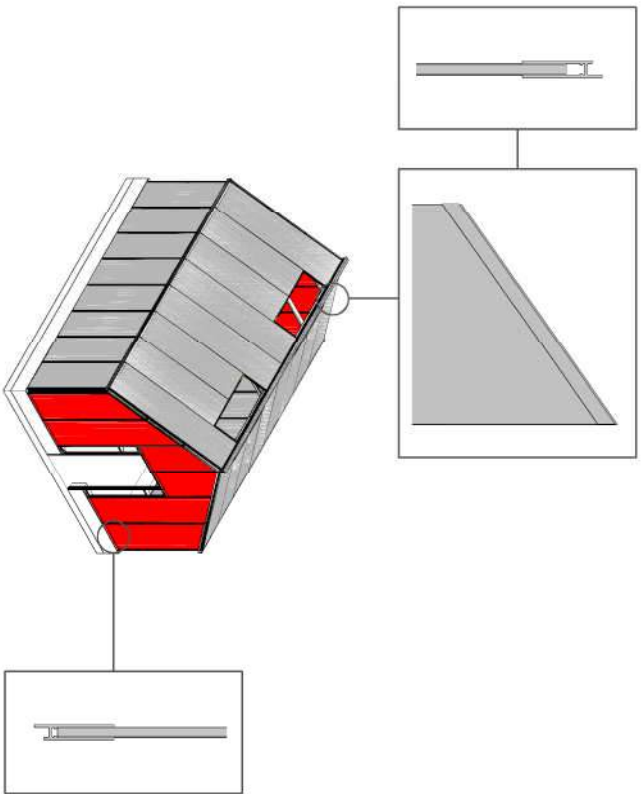

**1**

Peel paper from  
Foam Tape

**2**

**3**

**4**

**PRO TIPS**

*h-Channels for the top of the Polycarbonate are cut at angle on both ends to match the roof pitch of the greenhouse.*

Typical Polycarbonate  
(Gable Wall)

*Polycarbonate Panels, Glazing Caps & h-Channels will come packaged specific to their location in the greenhouse. Open the Bundles only as you need them.*

**Parts List:**



Glazing Caps



Glazing Caps (Ripped)



h-Channels



Twinwall Polycarbonate Panels



#8 x  $\frac{5}{8}$ " S.S. Screws

**PRO TIPS**



Start by glazing the 4 corners on the gable walls of the greenhouse. This will help to square the frame from left to right. Don't be afraid to shift the Frame as necessary.

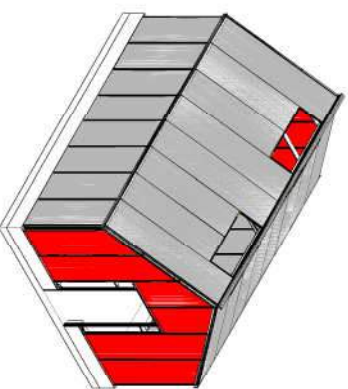

**STAGE 17B: GABLE GLAZING - (6MM TWINWALL POLYCARBONATE)**

**STEPS:**

5. SLIP THE TOP OF THE POLYCARBONATE PANEL BENEATH THE END RAFTER.
6. PUSH THE BOTTOM OF THE POLYCARBONATE PANEL INTO POSITION.
7. PUSH THE TOP H-CHANNEL UP UNTIL IT TOUCHES THE UNDERSIDE OF THE END RAFTER.

REPEAT FOR ALL ANGLE-CUT GABLE GLAZING

CONTINUE ON NEXT PAGE

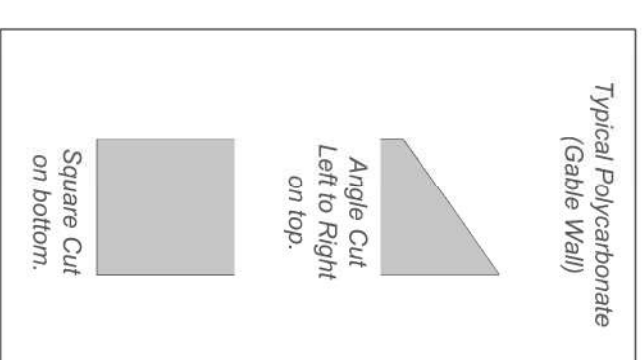
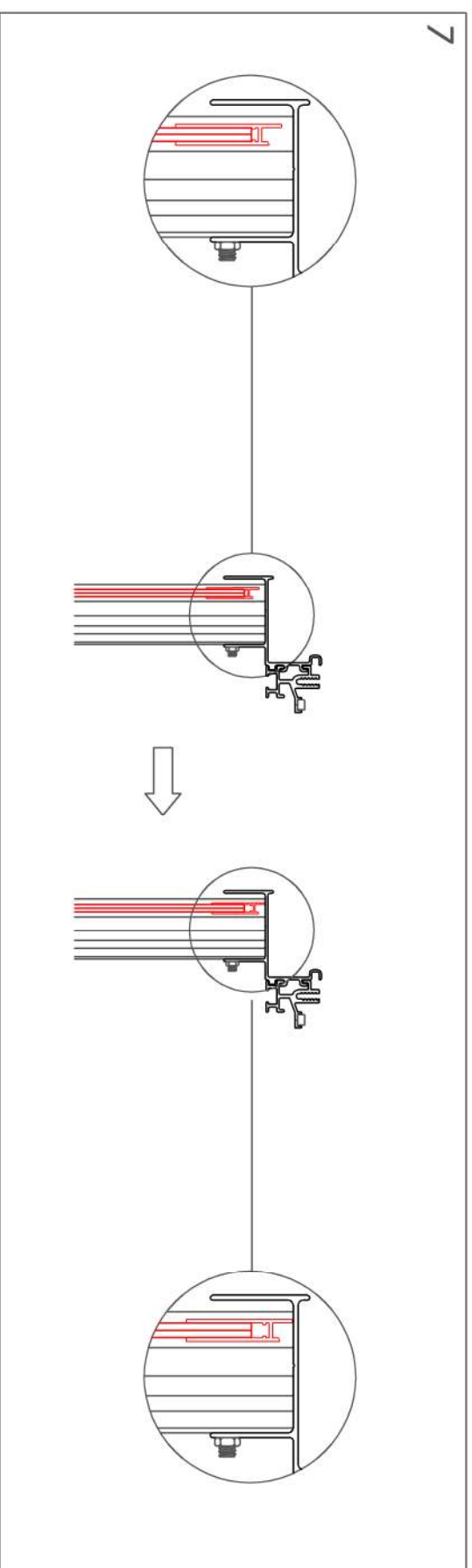
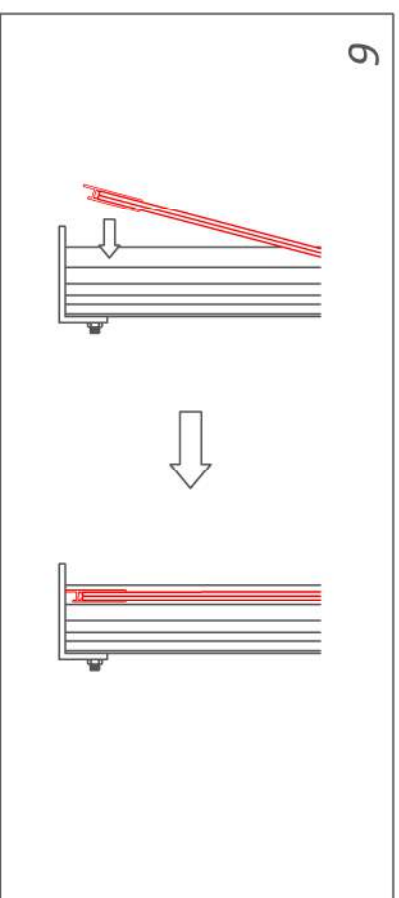
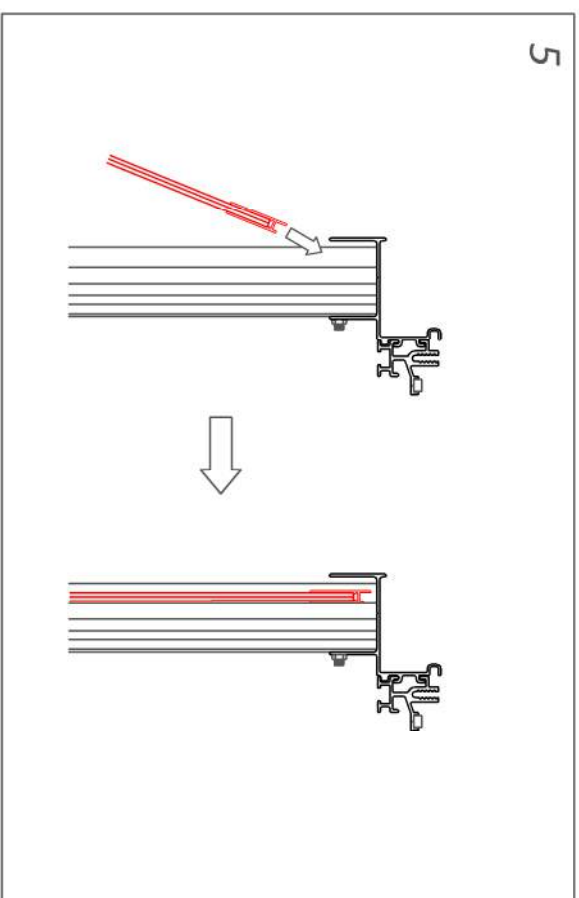
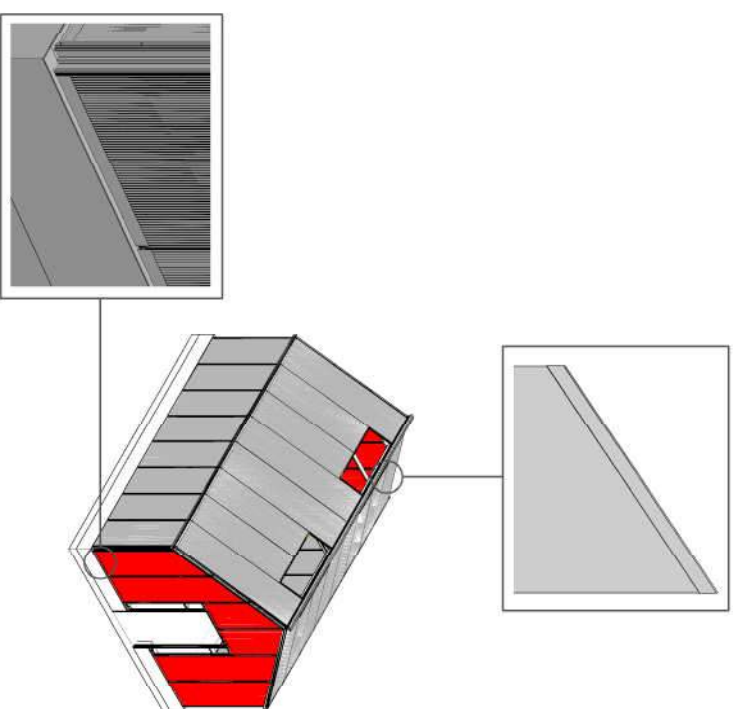

**Parts List:**



Glazing Caps



Glazing Caps (Ripped)



h-Channels



Twinwall Polycarbonate Panels



#8 x  $\frac{5}{8}$ " S.S. Screws

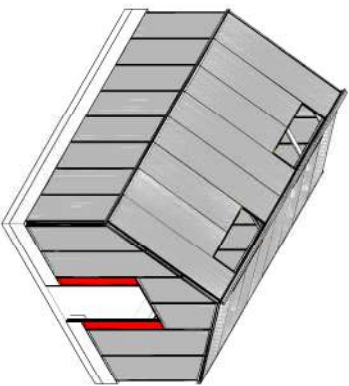

**STAGE 17C: BESIDE DOOR GLAZING - (6MM TWINWALL POLYCARBONATE)**

**STEPS:**

8. PLACE THE H-CHANNELS ONTO THE TOP & BOTTOM OF THE NARROW POLYCARBONATE PANELS INTENDED FOR BESIDE THE DOOR.
  9. FILL THE GAP BETWEEN THE BASE AND THE DOOR FRAME WITH CAULKING.
  10. SLIP THE POLYCARBONATE PANELS INTO THE TRACK ON THE SIDE OF THE DOOR FRAME & ROTATE INTO POSITION.
  11. PUSH THE TOP H-CHANNEL UP UNTIL IT TOUCHES THE BOTTOM OF THE DOOR HEADER.
- CONTINUE ON NEXT PAGE

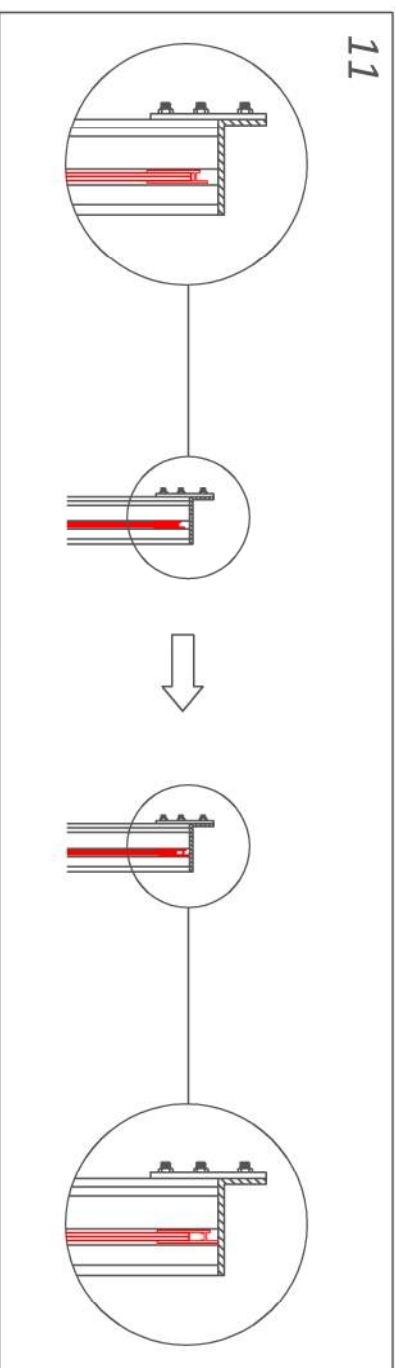
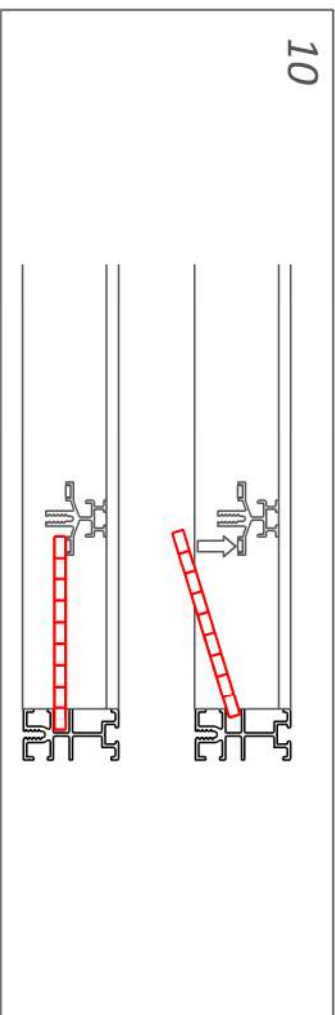
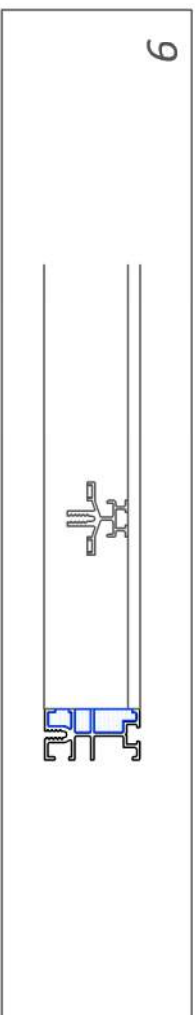
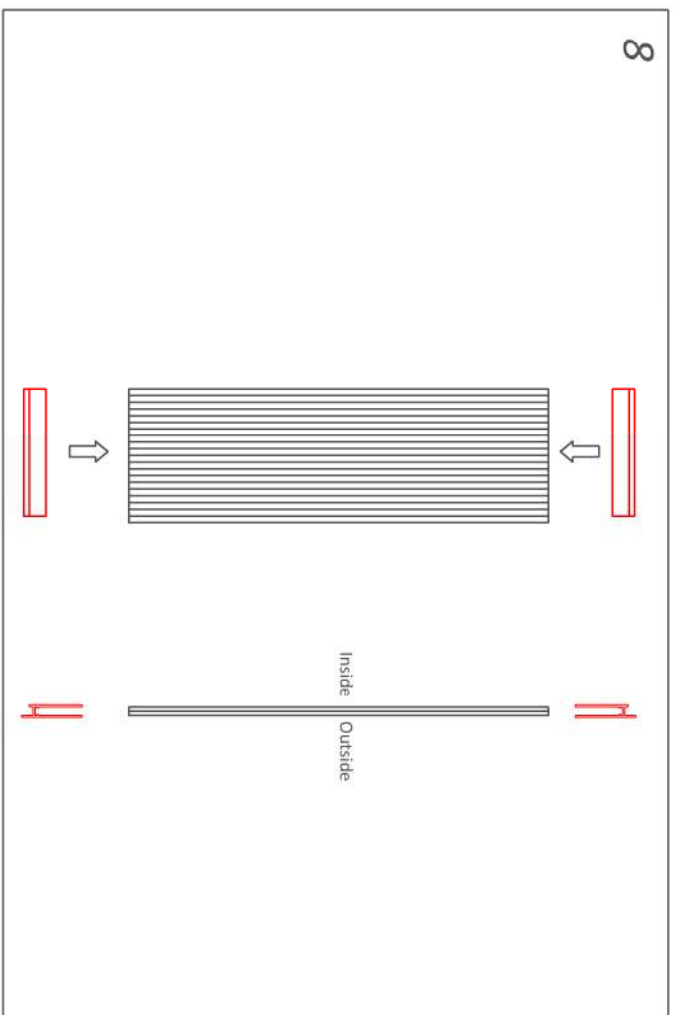
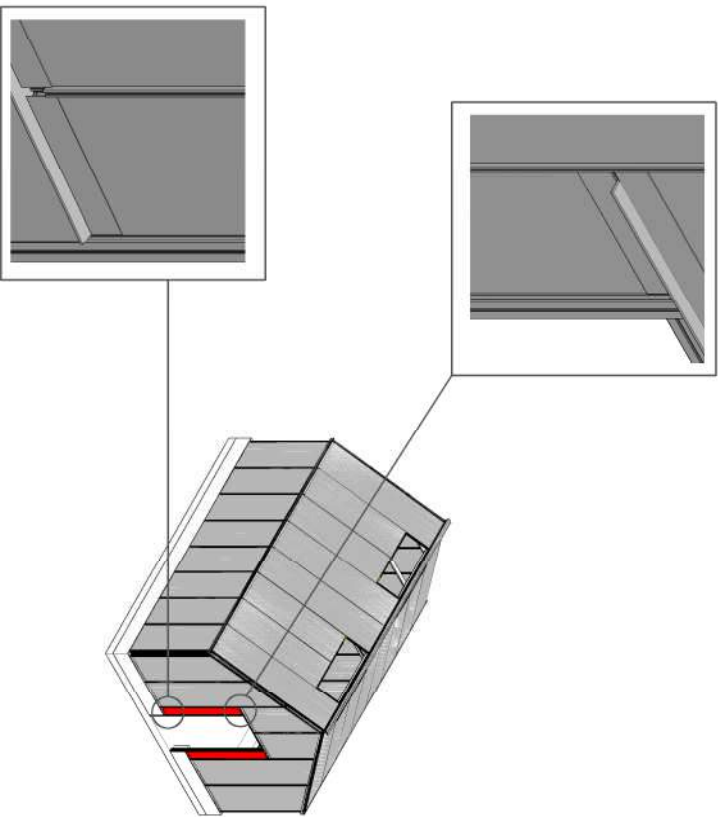

**PRO TIPS**

Marking the top outside corner of the polycarbonate panel will help you to identify the outside surface once the film is peeled..



**Parts List:**



Glazing Caps



Glazing Caps (Ripped)



h-Channels



Caulking



Twinwall Polycarbonate Panels



Twinwall Polycarbonate Panels (Narrow - Beside Door)



#8 x  $\frac{5}{8}$ " S.S. Screws



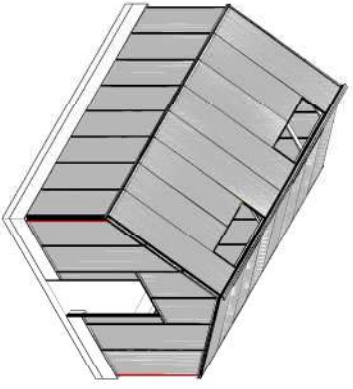

**STAGE 17D: GABLE CORNER CAPS -  
(6MM TWINWALL POLYCARBONATE)**

STEPS:

- 12. TUCK THE TOP OF THE RIPPED CAP BENEATH THE END RAFTER AND INSIDE THE CORNER POST.
- 13. SECURE THE CAP TO THE GLAZING BAR.

REPEAT FOR ALL CORNERS

CONTINUE ON NEXT PAGE

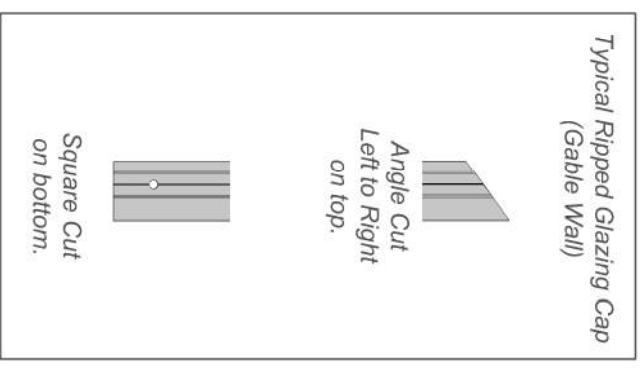
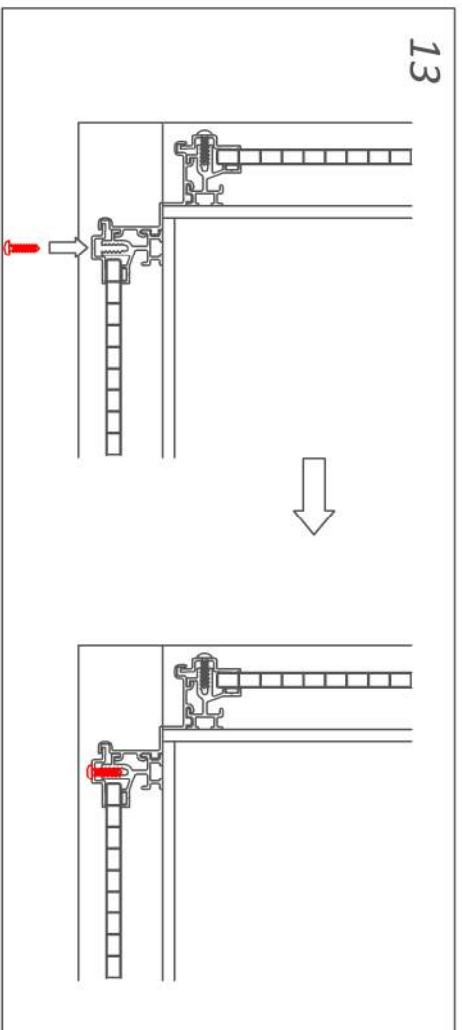
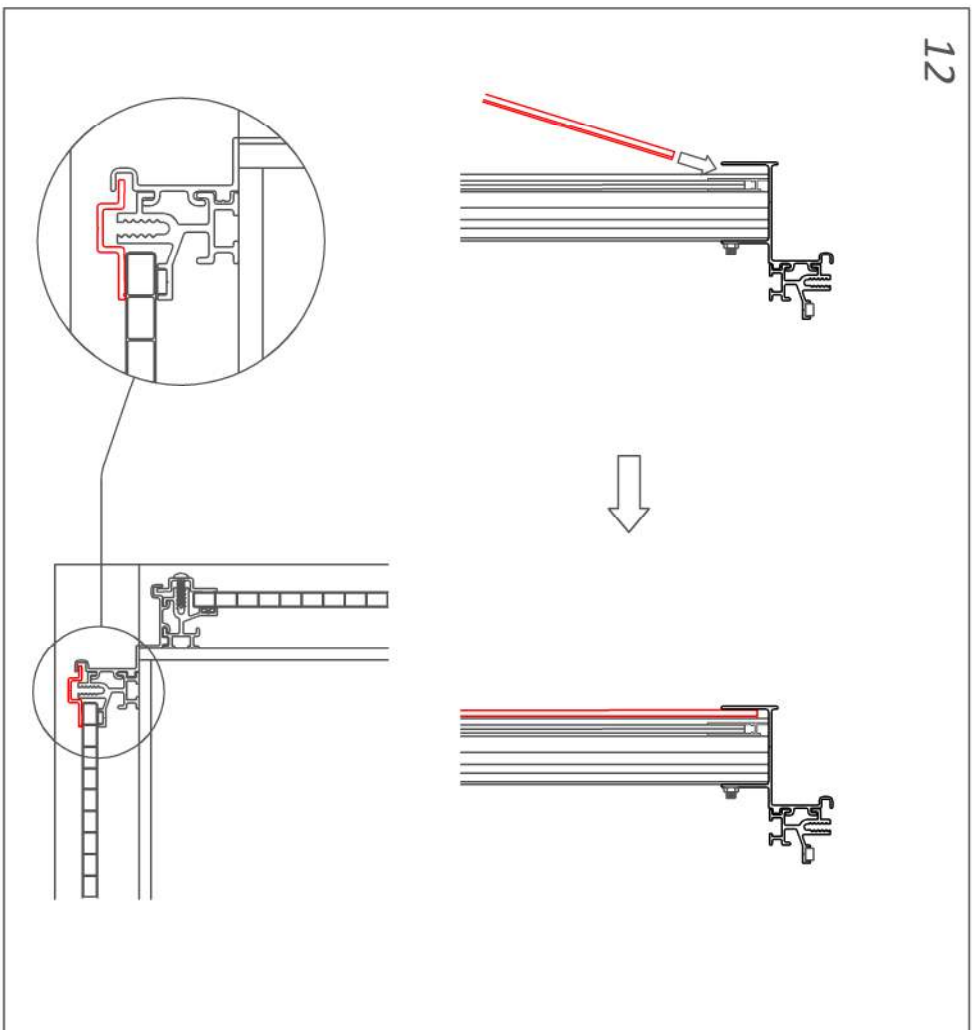
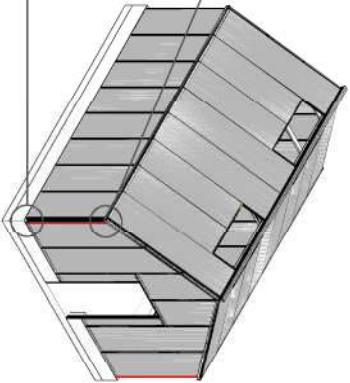
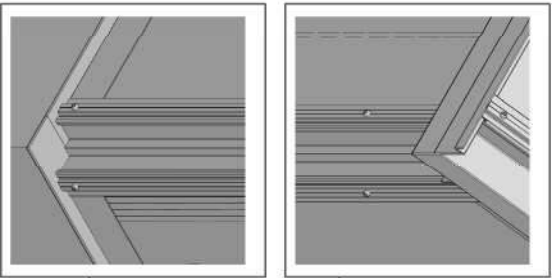

Parts List:



Glazing Caps



Glazing Caps (Ripped)



h-Channels



Twinwall Polycarbonate Panels



#8 x 5/8" S.S. Screws

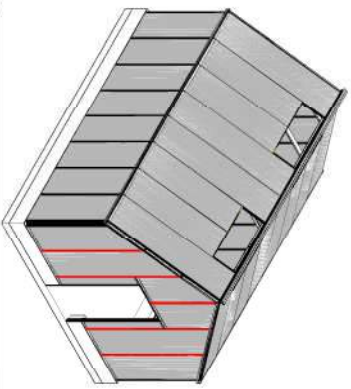

**STAGE 17E: GABLE CAPS -  
(6MM TWINWALL POLYCARBONATE)**

STEPS:

14. TUCK THE TOP OF THE CAP BENEATH THE END RAFTER.
  15. SECURE THE CAP TO THE GLAZING BAR.
- REPEAT FOR ALL REMAINING CAPS

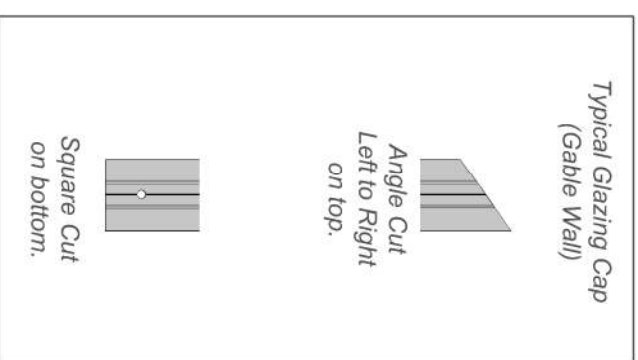
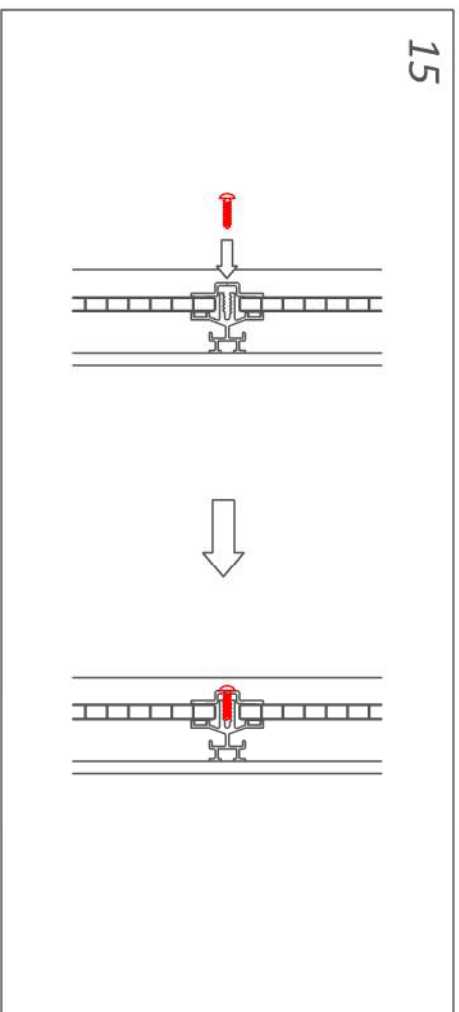
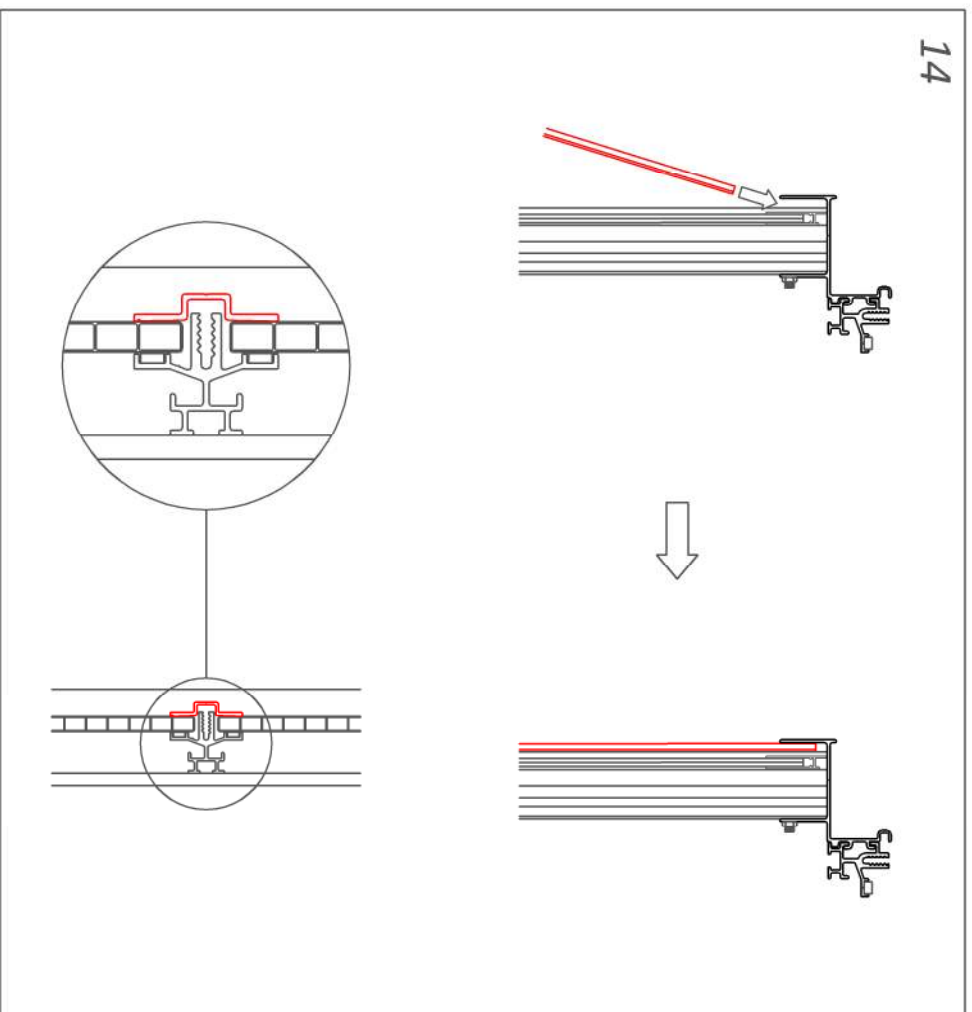
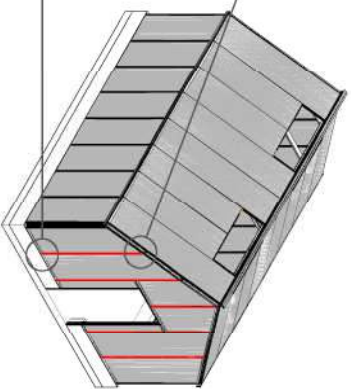
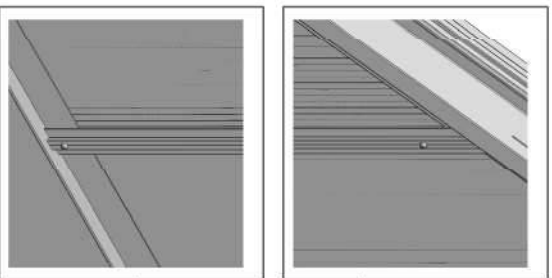

Parts List:



Glazing Caps



Glazing Caps (Ripped)



h-Channels



Twinwall Polycarbonate Panels



#8 x  $\frac{5}{8}$ " S.S. Screws

# STAGE 18: SEALING - (6MM TWINWALL POLYCARBONATE)

- CLEAR SILICONE (PROGLAZE)
- COLORED CAULKING (TREMCO 830)

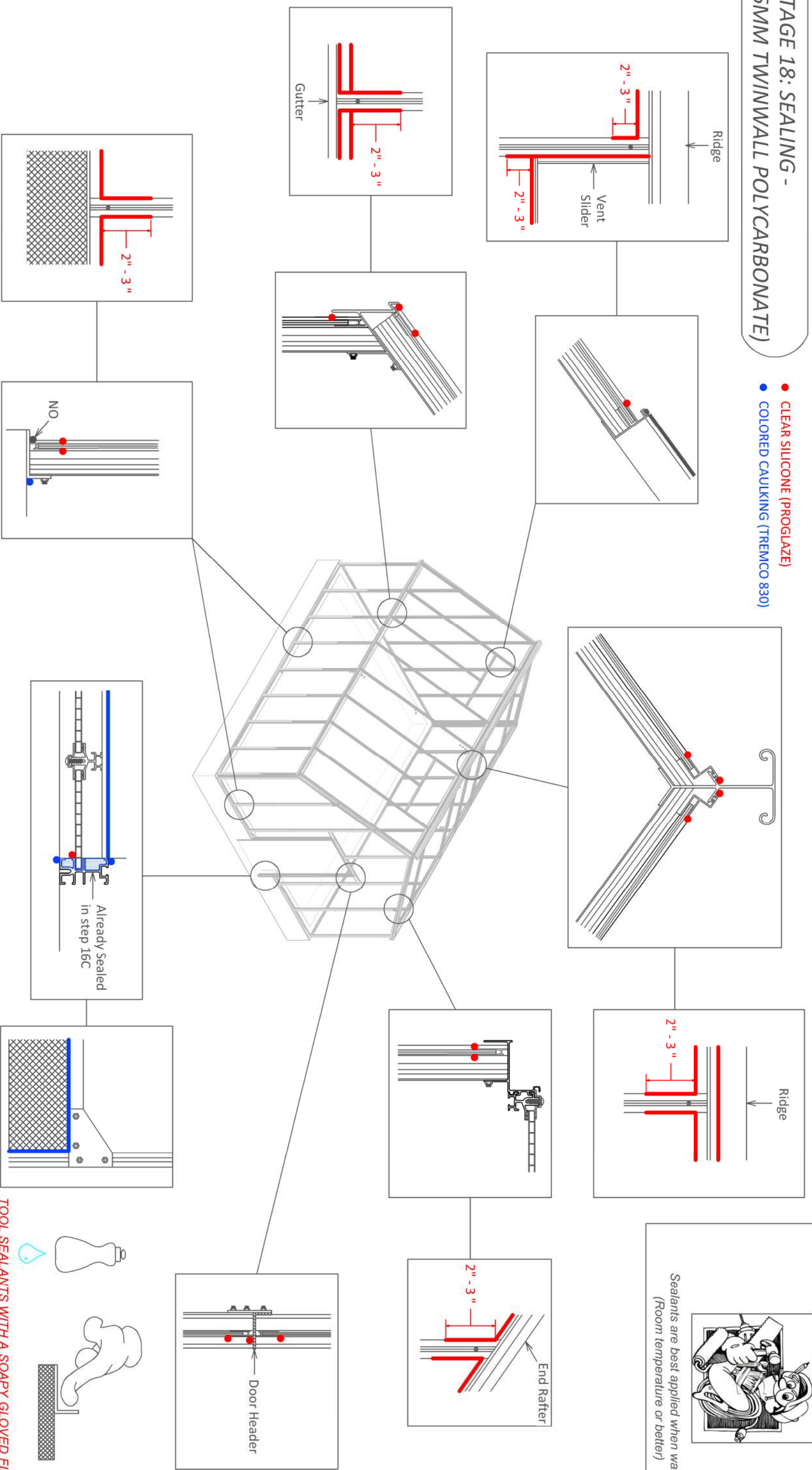

## Parts List:

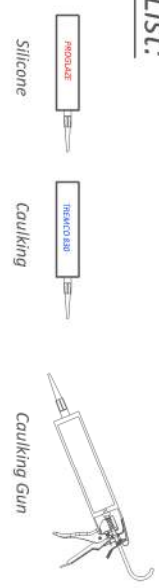

## PRO TIPS



Sealants are best applied when warm  
(Room temperature or better)

TOOL SEALANTS WITH A SOAPY GLOVED FINGER  
OR A CAULK-SMOOTHING TOOL.

**STAGE 19A: FOIL TAPE -  
(16MM 5WALL POLYCARBONATE)**

- STEPS:**
1. CUT SOLID & VENTED FOIL TAPES INTO APPROPRIATE LENGTHS.
  2. PEEL THE FILM BACK FROM THE EDGES OF THE POLYCARBONATE PANELS.
  3. MARK ONE OUTSIDE CORNER OF THE POLYCARBONATE PANELS WITH A FELT PEN.
- CONTINUE ON NEXT PAGE

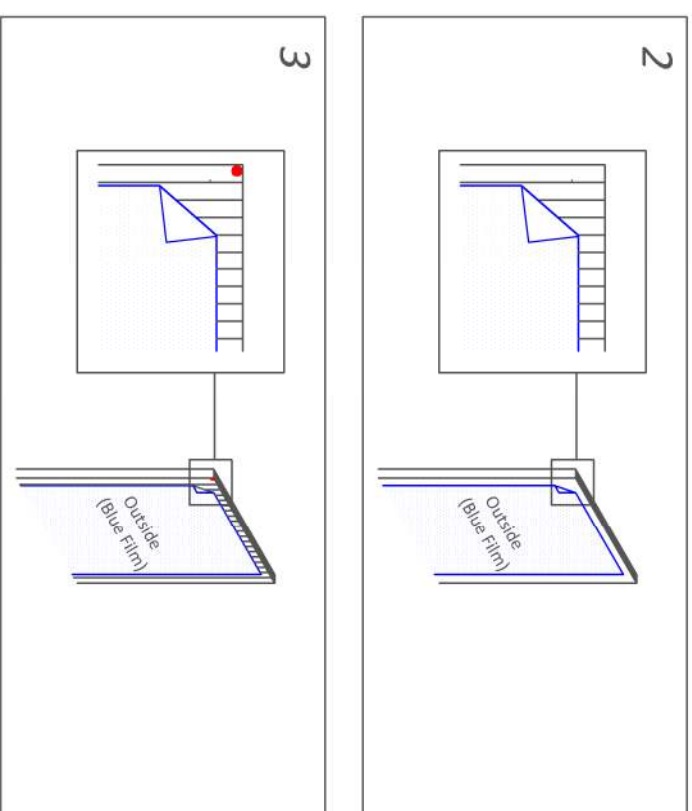
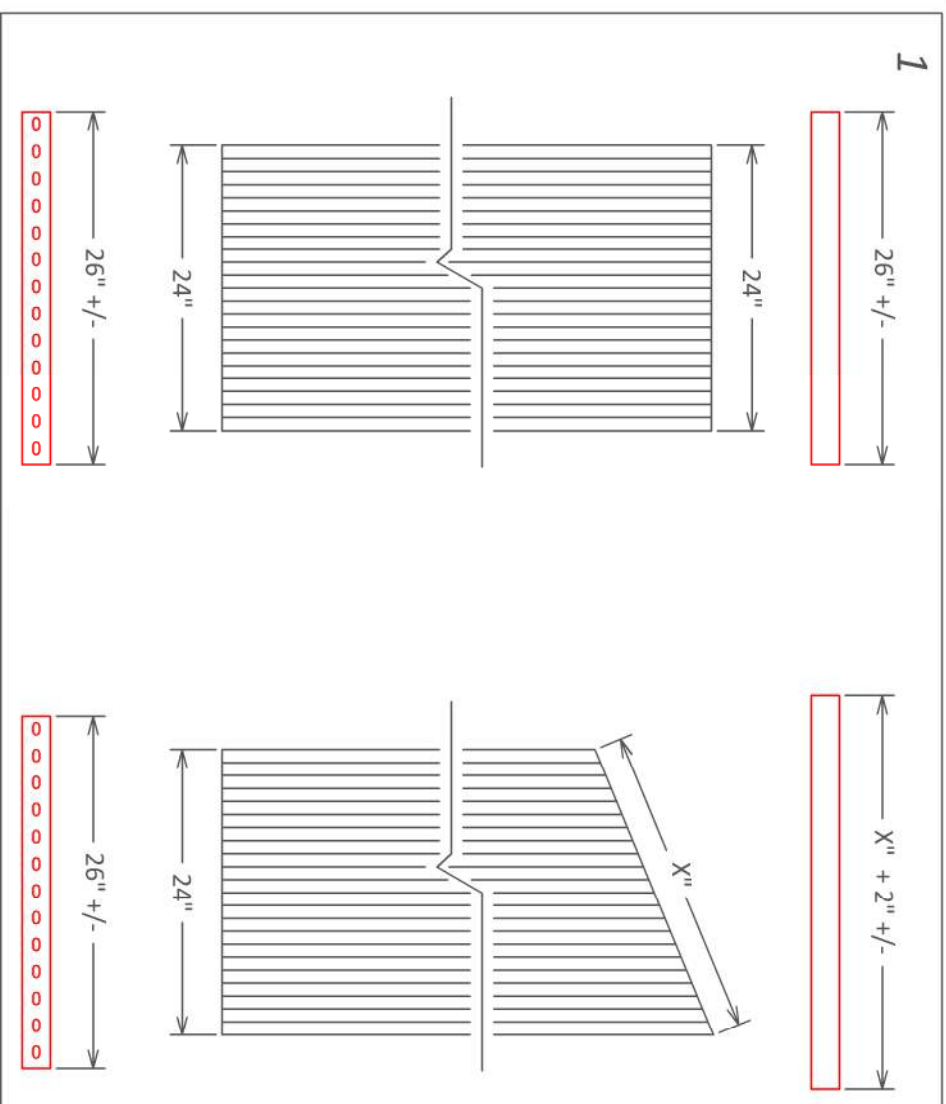
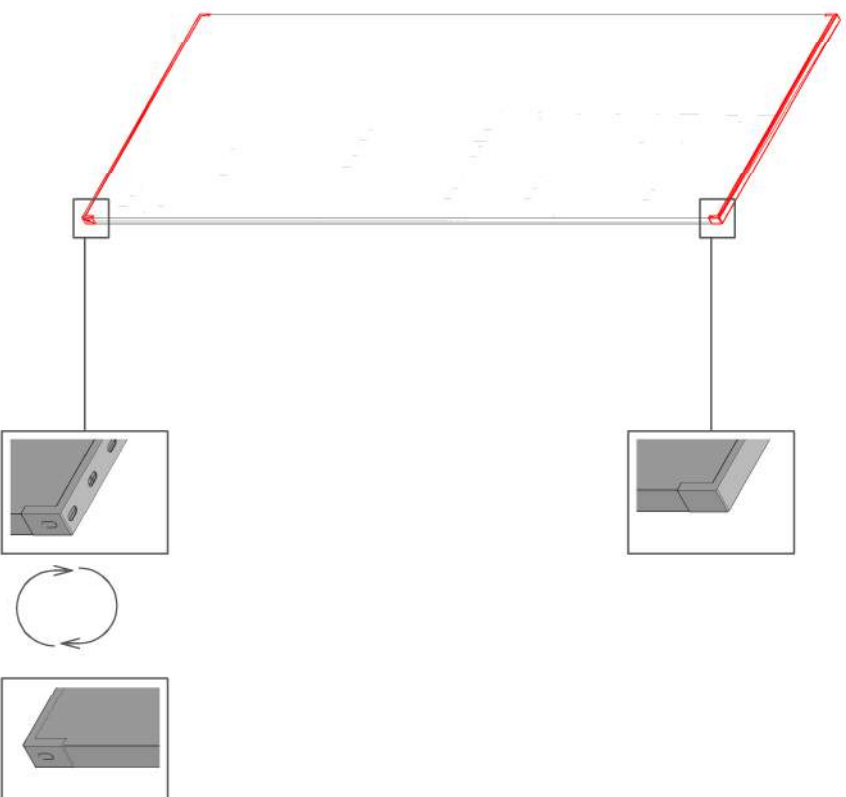

**Parts List:**

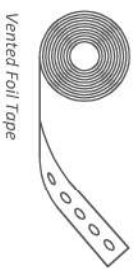
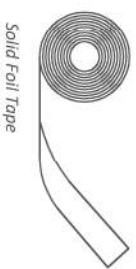

5 Wall Polycarbonate Panels

**PRO TIPS**



When marking the corner of the panels, do so as close to the edge of that panel as possible so that the mark is hidden once installed.

### STAGE 19B: FOIL TAPE - (16MM SMALL POLYCARBONATE)

- STEPS:
4. PLACE A PIECE OF SOLID FOIL TAPE EVENLY ON THE TOP OF A POLYCARBONATE PANEL & SMOOTHLY FOLD THE EDGES OVER.
  5. FLIP THE POLYCARBONATE PANEL OVER.
  6. PLACE A PIECE OF VENTED FOIL TAPE EVENLY ON THE BOTTOM OF A POLYCARBONATE PANEL & SMOOTHLY FOLD THE EDGES OVER.

REPEAT FOR ALL POLYCARBONATE PANELS

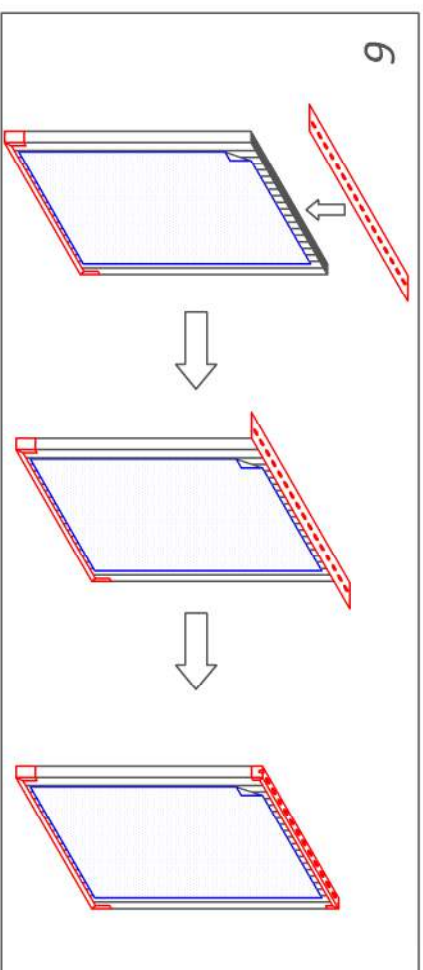
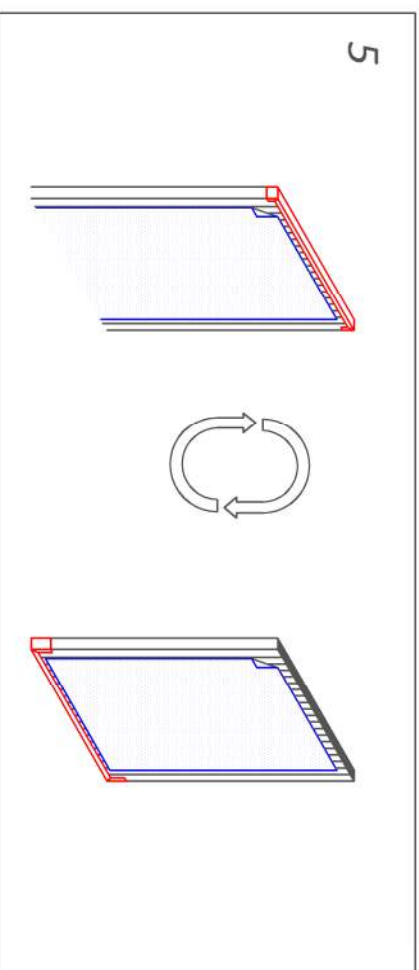
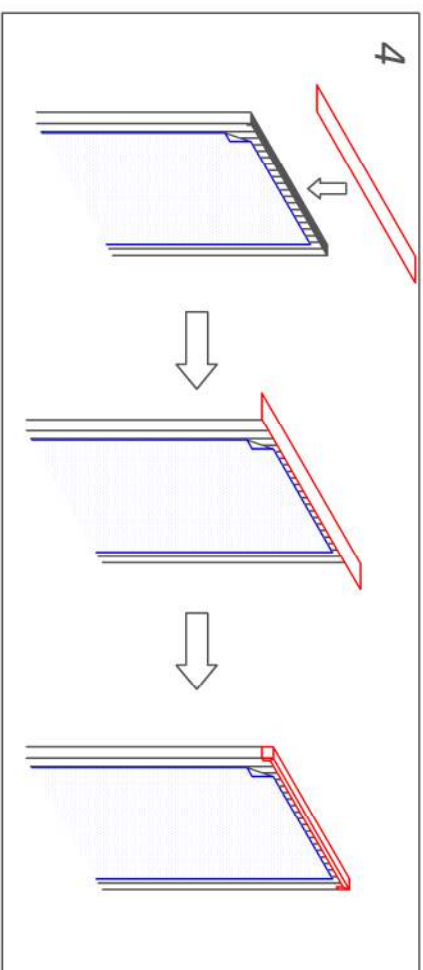
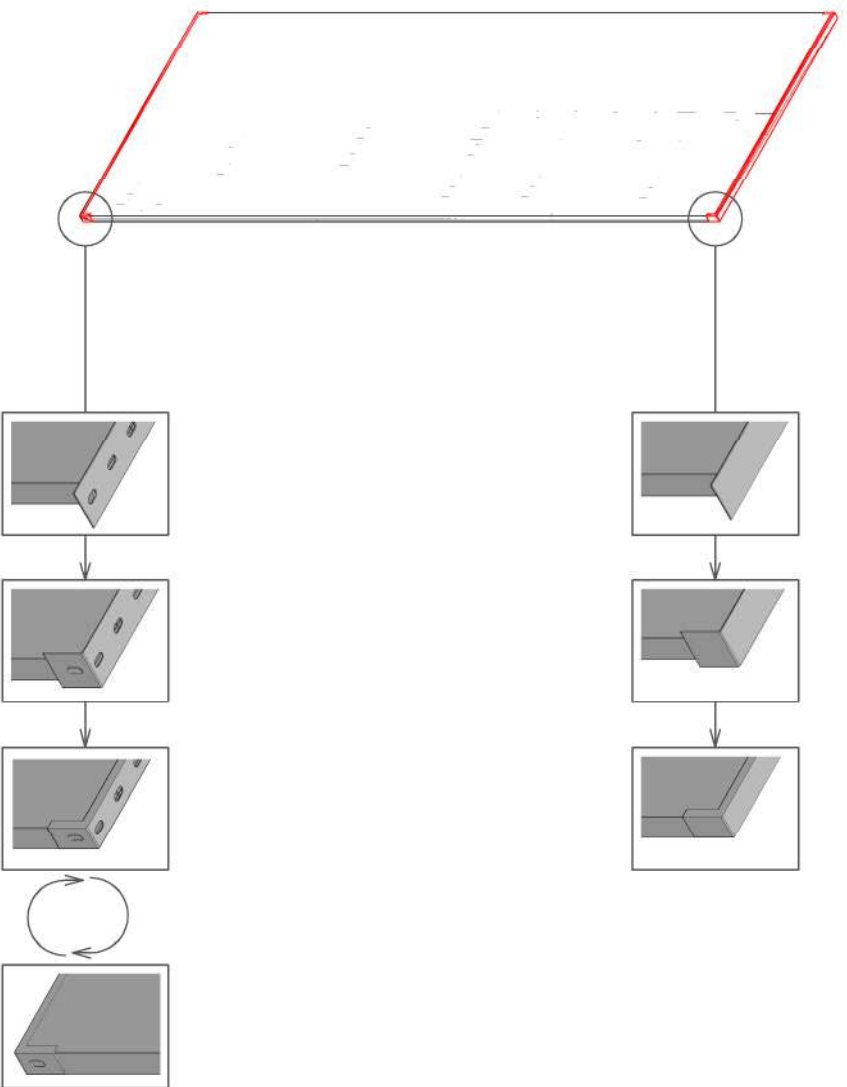

Parts List:

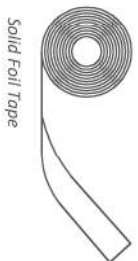

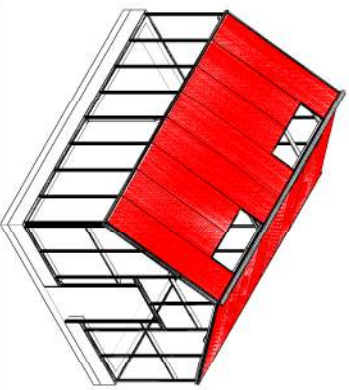

GLAZE & CAP THE ROOF IN ORDER FROM BACK TO FRONT AND THEN FRONT TO BACK. COMPLETE ONE SIDE BEFORE BEGINNING THE NEXT.

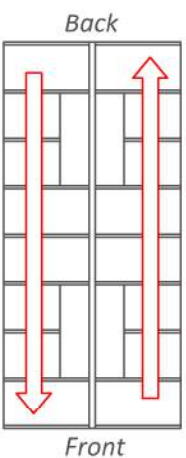

**STAGE 20A: ROOF GLAZING - (16MM 5WALL POLYCARBONATE)**

- STEPS:**
1. PEELE THE BROWN PAPER FROM THE FOAM TAPE ON THE ROOF GLAZING BARS.
  2. PEELE THE FILM OFF BOTH SIDES OF THE POLYCARBONATE PANEL.
  3. PLACE THE H-CHANNEL ONTO THE BOTTOM OF A POLYCARBONATE PANEL.
- CONTINUE ON NEXT PAGE

*If using a cordless drill to fasten the Caps, set your drill to a low Torque Setting. Screws should be snug to the cap plus a quarter turn.*

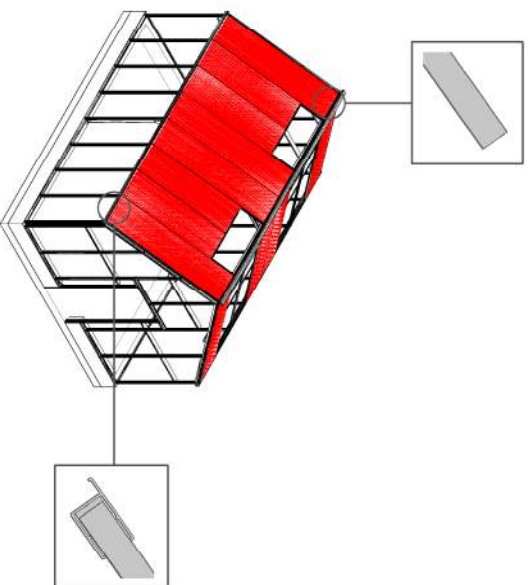

**1**

Peel paper from Foam Tape

**2**

**3**

**PRO TIPS**

Have one person working outside the greenhouse and one on the inside to help fit the polycarbonate panels into the Ridge.

Typical Polycarbonate (Roof)

Square Cut on top.

Square Cut on bottom.

**\*WARNINGS\***

- DO NOT STORE POLYCARBONATE PANELS IN DIRECT SUNLIGHT- The Plastic Film can melt onto the panels if they get too hot.

-DO NOT LAY POLYCARBONATE PANELS DIRECTLY ON THE GRASS- Doing so can burn / Kill the grass

Due to circumstances beyond our control, the polycarbonate may not have Blue Film identifying the outside surface. In this situation, the outside surface will be identified with Text.

On hot days, you may find that the Glazing Foam is too sticky. Spraying the foam with a light soapy water will make installing the Polycarbonate easier.

Polycarbonate Panels, Glazing Caps & h-Channels will come packaged specific to their location in the greenhouse. Open the Bundles only as you need them.

**Parts List:**

- Glazing Caps
- Glazing Caps (Ripped)
- h-Channels (Top)
- h-Channels (Bottom)
- Small Polycarbonate Panels
- Setting Blocks
- #8 x 3/4" S.S. Screws



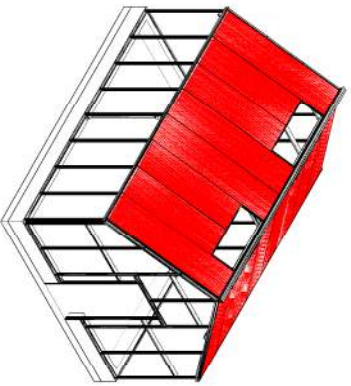

**STAGE 20B: ROOF GLAZING -  
(16MM SMALL POLYCARBONATE)**





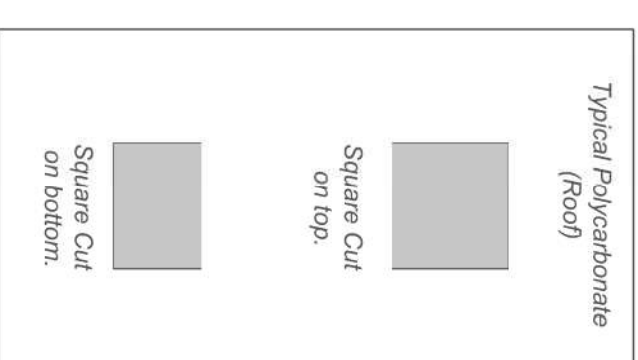
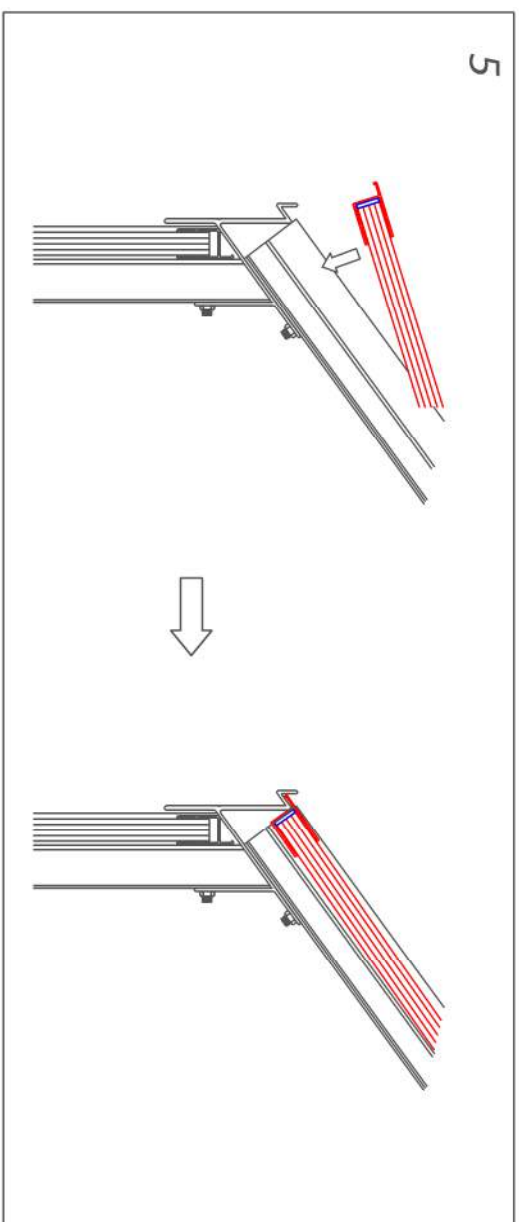
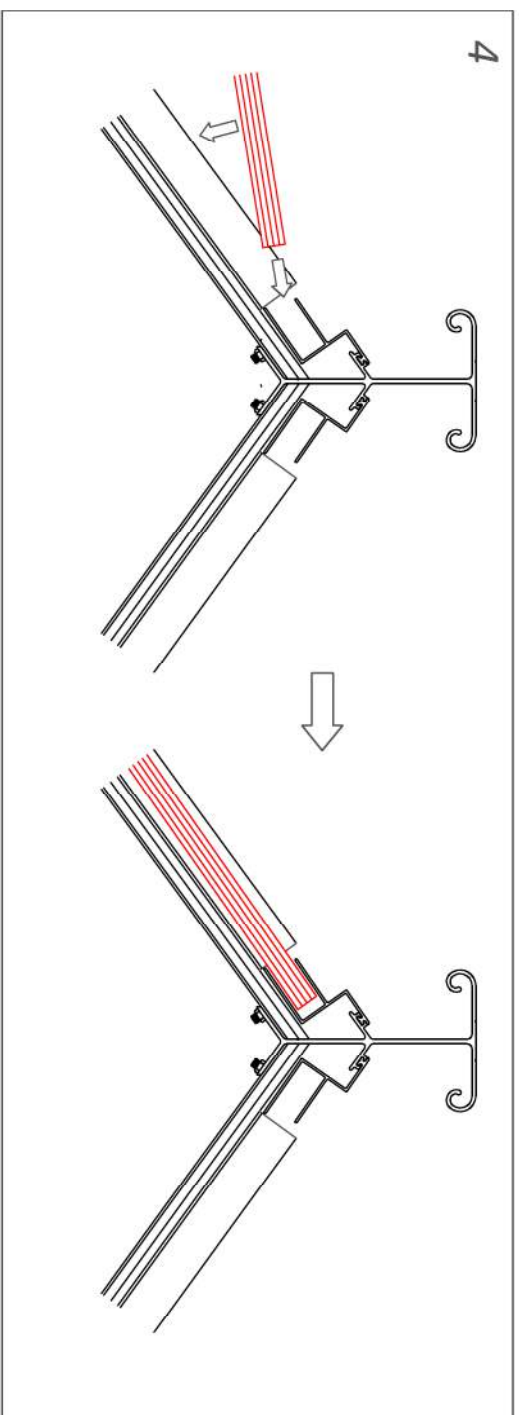
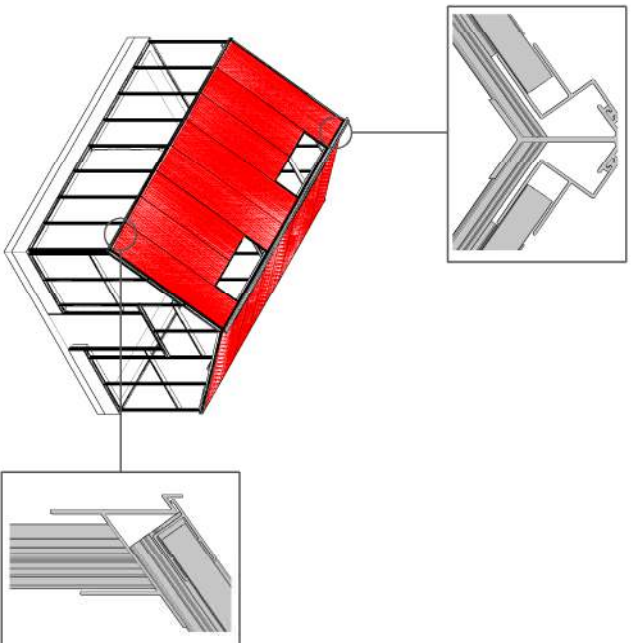

**STEPS:**

4. INSERT THE TOP OF THE POLYCARBONATE PANEL INTO THE RIDGE.
  5. INSERT THE H-CHANNEL AT THE BOTTOM OF THE PANEL INTO THE GUTTER.
- REPEAT

CONTINUE ON NEXT PAGE

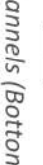

**Parts List:**

-  Glazing Caps
-  Glazing Caps (Ripped)
-  h-Channels (Top)
-  h-Channels (Bottom)
-  Small Polycarbonate Panels
-  Setting Blocks
-  #8 x 3/4" S.S. Screws

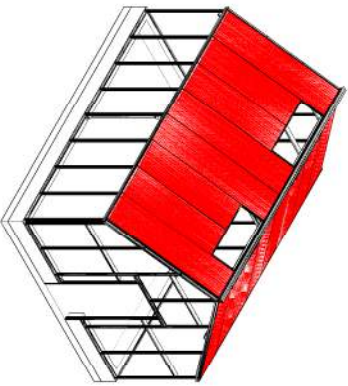

**STAGE 20C: ROOF GLAZING -  
(16MM SMALL POLYCARBONATE)**



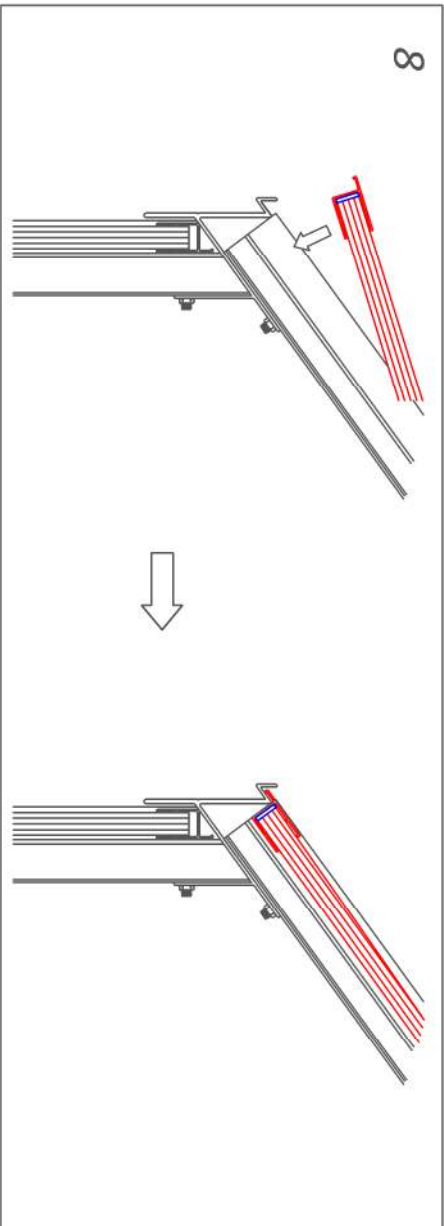
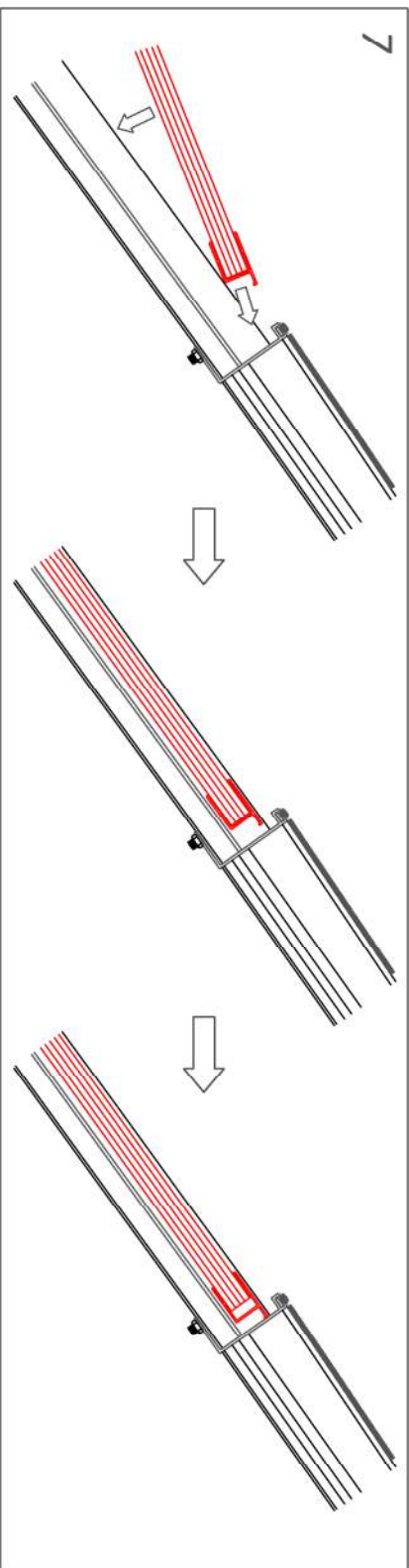
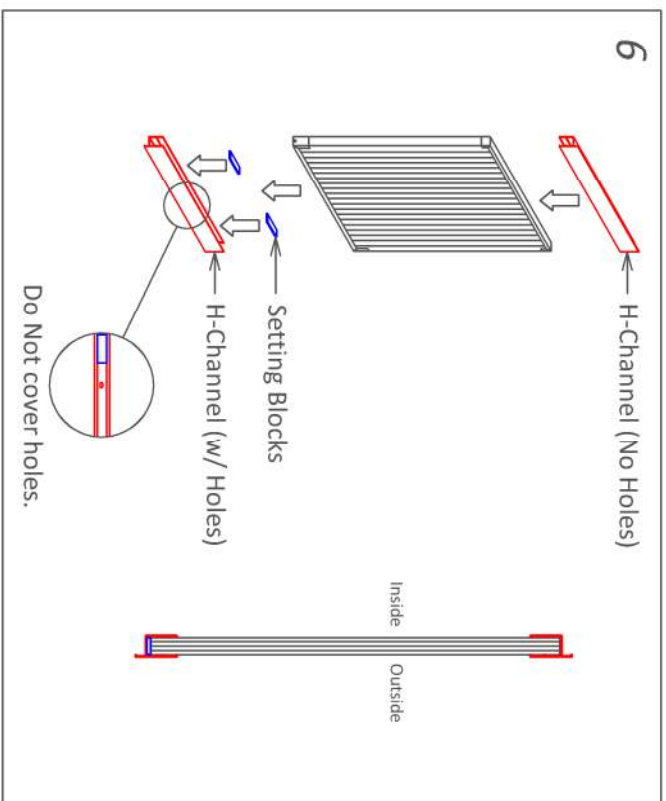
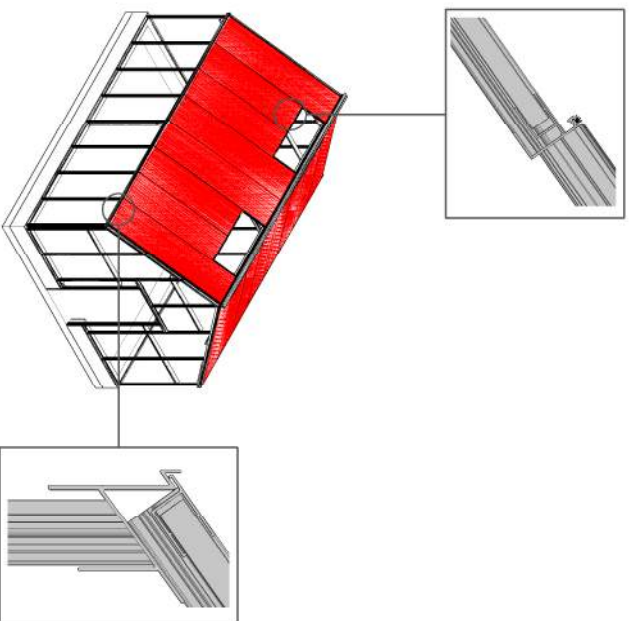

- STEPS:**
6. APPLY H-CHANNELS & SETTING BLOCKS TO TOP AND BOTTOM OF POLYCARBONATE PANELS.
  7. INSERT THE POLYCARBONATE PANEL BELOW THE VENT FRAME BOTTOM & SLIDE THE H-CHANNEL UP UNTIL IT TOUCHES THE VENT FRAME BOTTOM.
  8. INSERT THE H-CHANNEL AT THE BOTTOM OF THE PANEL INTO THE GUTTER.

REPEAT

CONTINUE ON NEXT PAGE

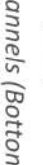

**Parts List:**

-  Glazing Caps
-  Glazing Caps (Ripped)
-  h-Channels (Top)
-  h-Channels (Bottom)
-  Small Polycarbonate Panels
-  Setting Blocks
- #8 x 3/4\" S.S. Screws" data-bbox="65 790 85 805"/> #8 x 3/4" S.S. Screws





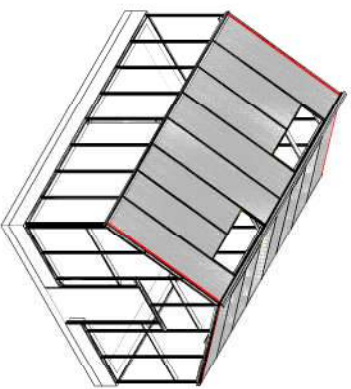

**STAGE 20D: ROOF END CAPS-  
(16MM 5WALL POLYCARBONATE)**

**STEPS:**





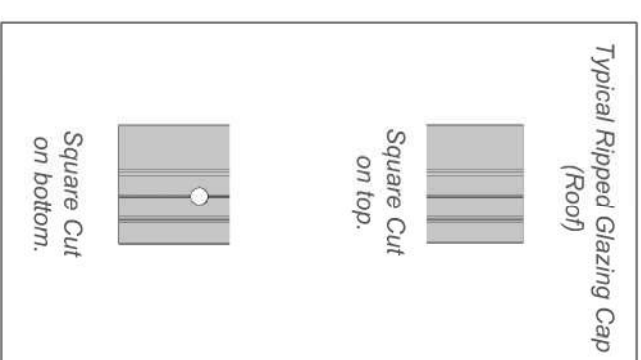
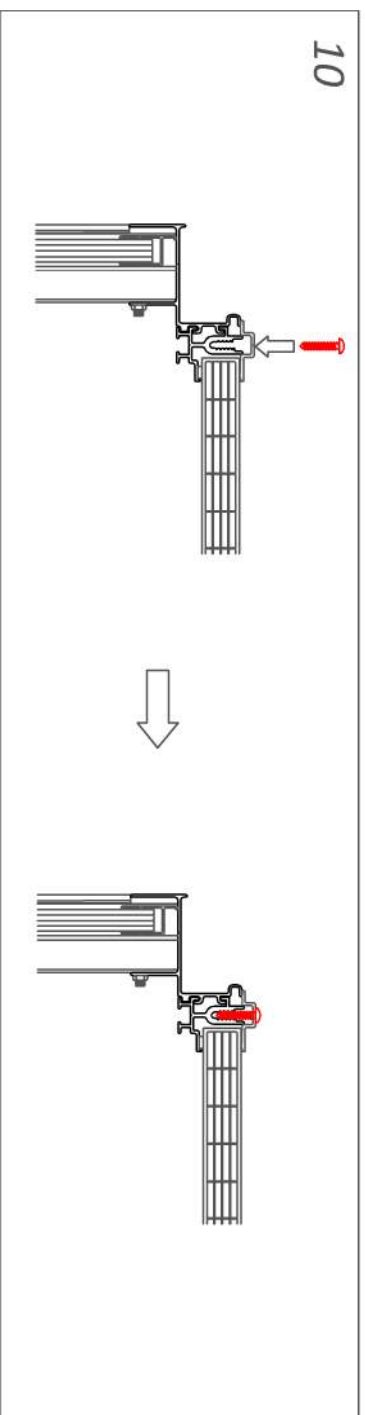
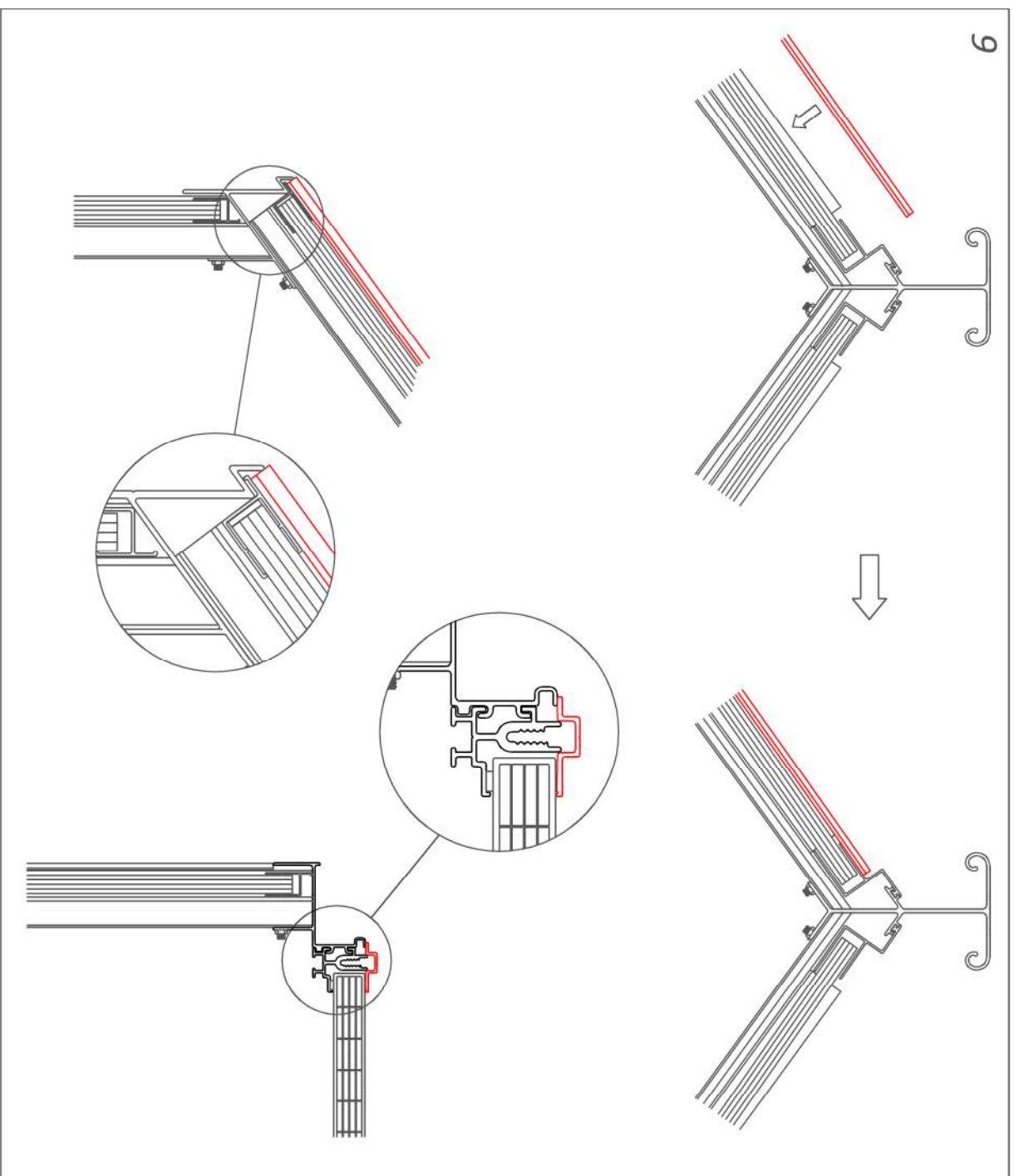
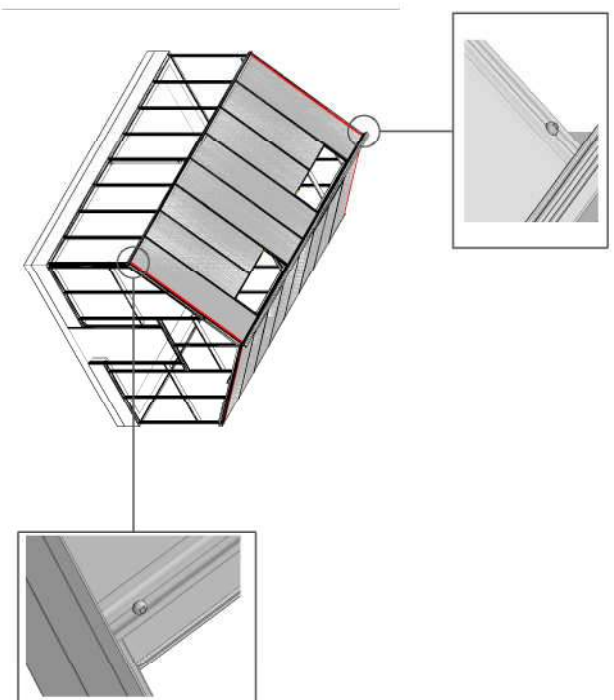

9. LAY THE RIPPED CAP ON THE END RAFTER & GLAZING BAR  
(CAP SHOULD SIT TIGHT TO THE GUTTER)
10. SECURE THE CAP TO THE GLAZING BAR.

REPEAT FOR ALL CORNERS

CONTINUE ON NEXT PAGE

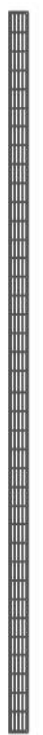

**Parts List:**

-  Glazing Caps
-  Glazing Caps (Ripped)
-  h-Channels (Top)
-  h-Channels (Bottom)
-  Small Polycarbonate Panels
-  Setting Blocks
-  #8 x 3/4" S.S. Screws

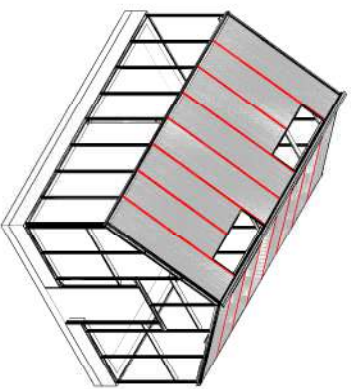





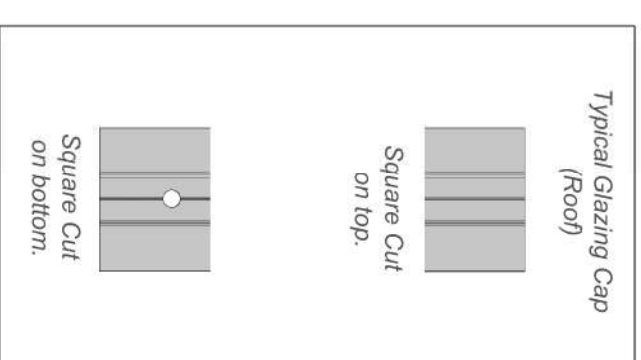
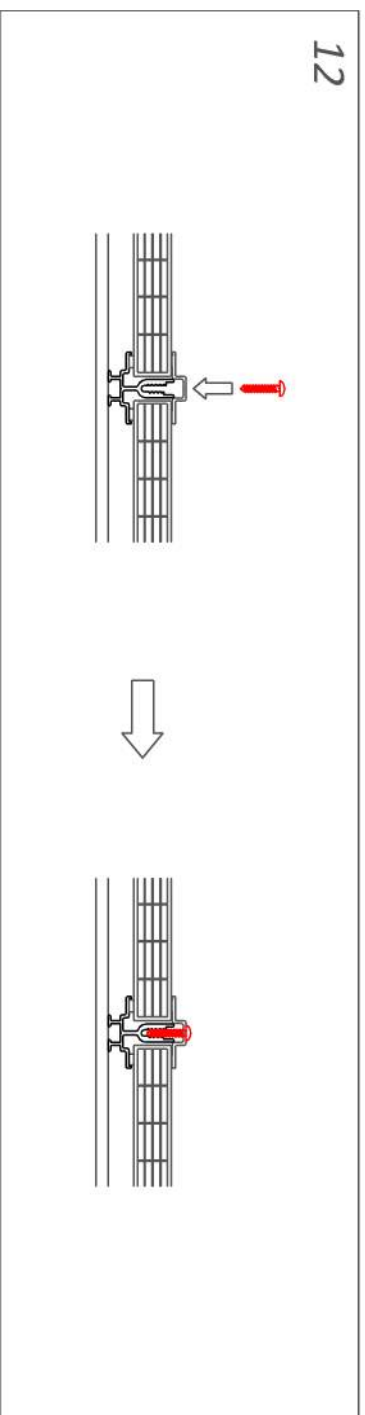
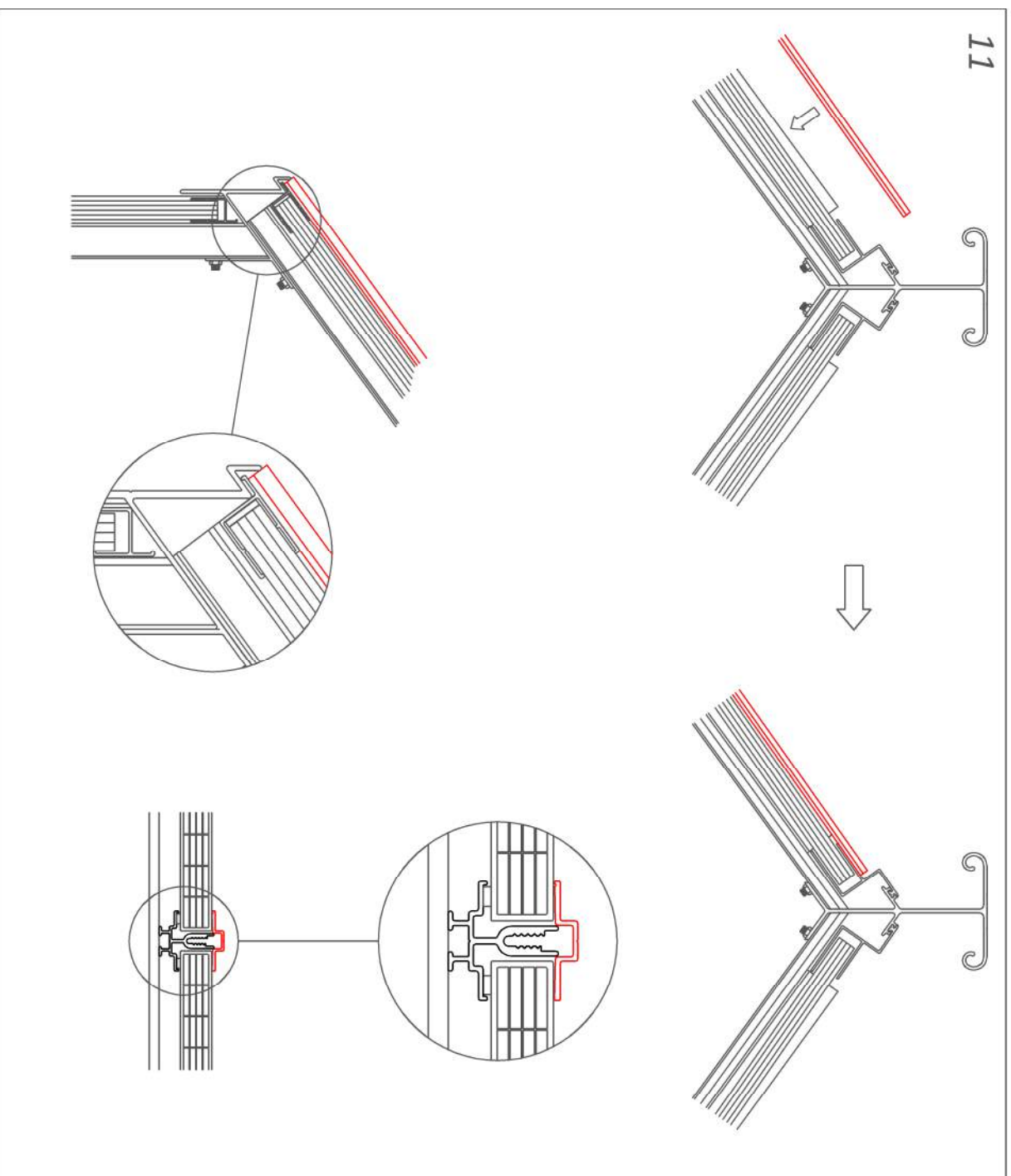
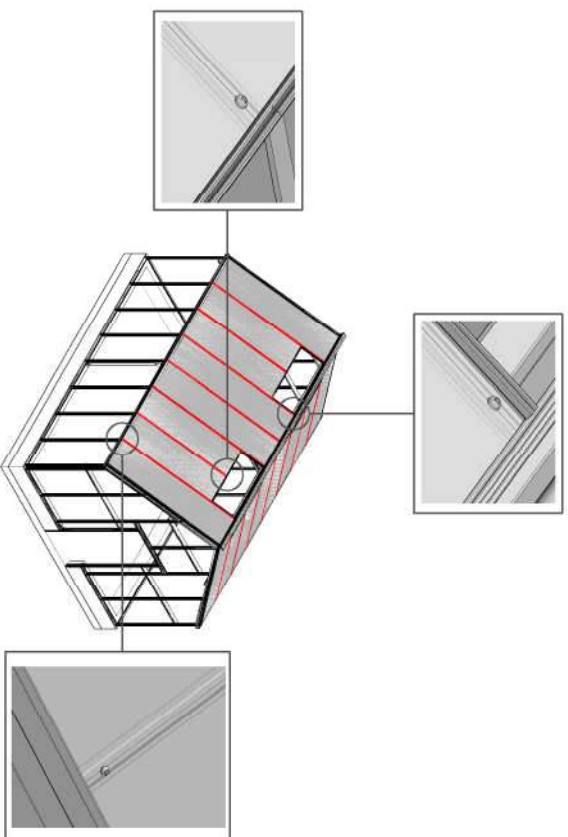

**STAGE 20E: ROOF CAPS -  
(16MM 5WALL POLYCARBONATE)**

- STEPS:**  
 11. LAY THE CAP ON THE GLAZING BAR (CAP SHOULD SIT TIGHT TO THE GUTTER)  
 12 SECURE THE CAP TO THE GLAZING BAR.  
 REPEAT FOR ALL REMAINING CAPS

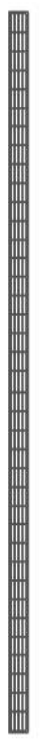

**Parts List:**

-  Glazing Caps
-  Glazing Caps (Ripped)
-  h-Channels (Top)
-  h-Channels (Bottom)
-  Small Polycarbonate Panels
-  Setting Blocks
-  #8 x 3/4" S.S. Screws

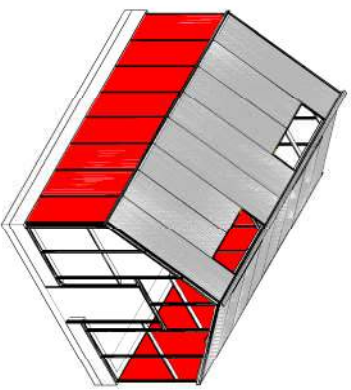





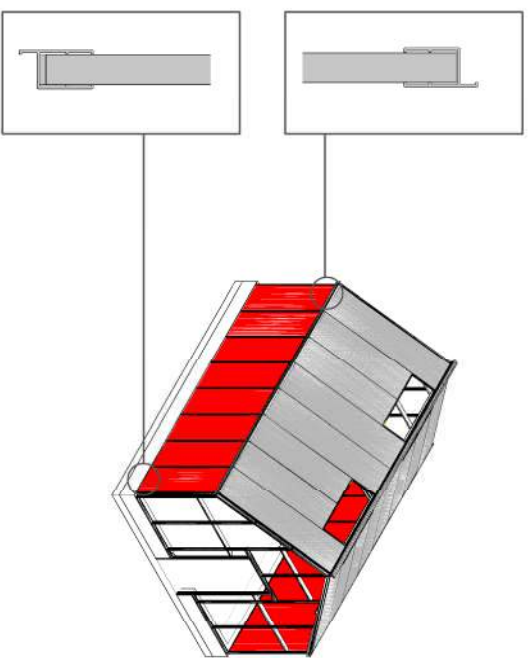

**STAGE 21A: SIDE WALL GLAZING -  
(16MM 5WALL POLYCARBONATE)**

- STEPS:**
1. PEELED THE BROWN PAPER FROM THE FOAM TAPE ON THE SIDE WALL GLAZING BARS.
  2. PEELED THE FILM OFF BOTH SIDES OF THE POLYCARBONATE PANEL.
  3. PLACED THE H-CHANNELS & SETTING BLOCKS ONTO THE TOP & BOTTOM OF A POLYCARBONATE PANEL.

CONTINUE ON NEXT PAGE



**Parts List:**

-  Glazing Caps
-  Glazing Caps (Ripped)
-  h-Channels (Top)
-  h-Channels (Bottom)
-  Swall Polycarbonate Panels
-  Setting Blocks
-  #8 x 3/4" S.S. Screws

**1**

Peel paper from Foam Tape



**2**

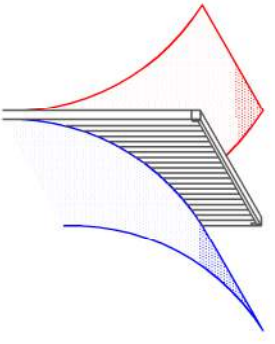

**3**

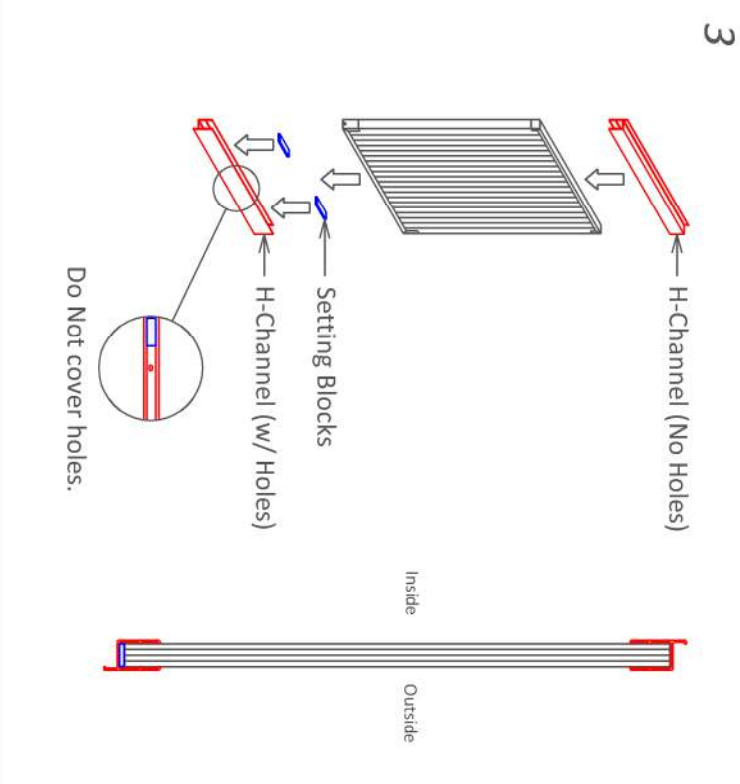

**PRO TIPS**



Applying a drop of silicone to the Setting Blocks before installing will prevent them from sliding out of position.

Typical Polycarbonate (Side Wall)



Square Cut on top.

Square Cut on bottom.

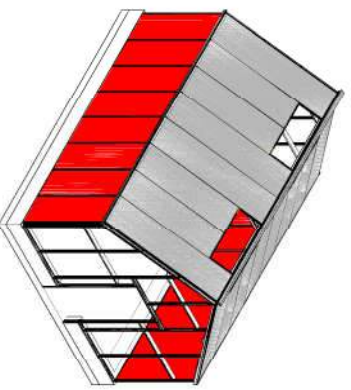

**STAGE 21B: SIDE WALL GLAZING -  
(16MM 5WALL POLYCARBONATE)**

**STEPS:**

4. SLIP THE TOP OF THE POLYCARBONATE PANEL BENEATH THE GUTTER.
5. PUSH THE BOTTOM OF THE POLYCARBONATE PANEL INTO POSITION.
6. PUSH THE TOP H-CHANNEL UP UNTIL IT TOUCHES THE UNDERSIDE OF THE GUTTER.

REPEAT FOR ALL SIDE WALL GLAZING

CONTINUE ON NEXT PAGE

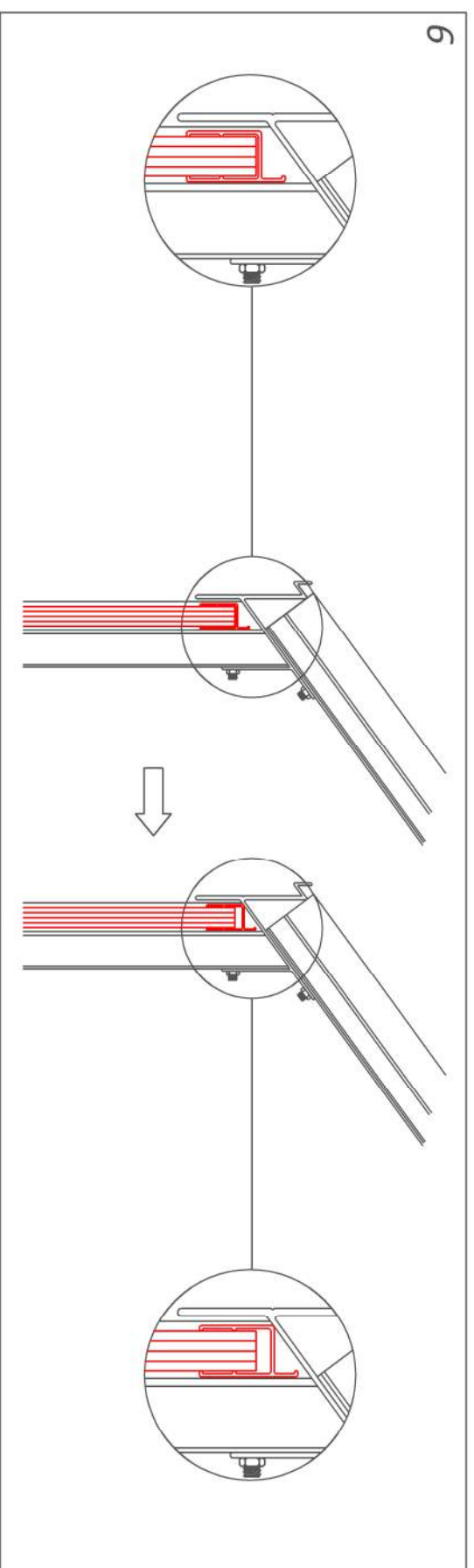
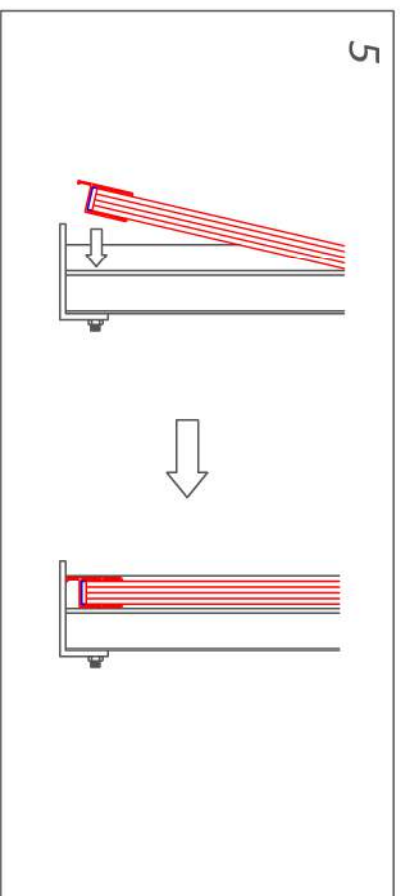
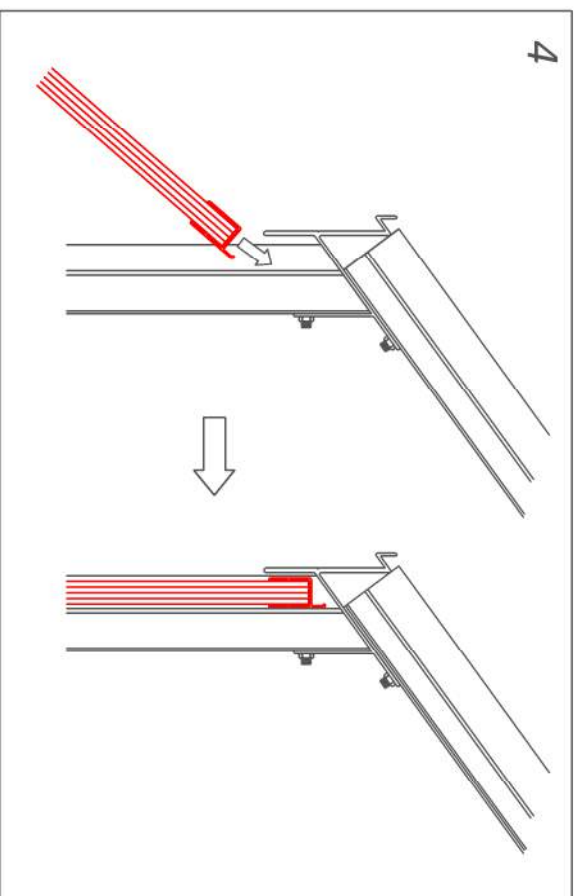
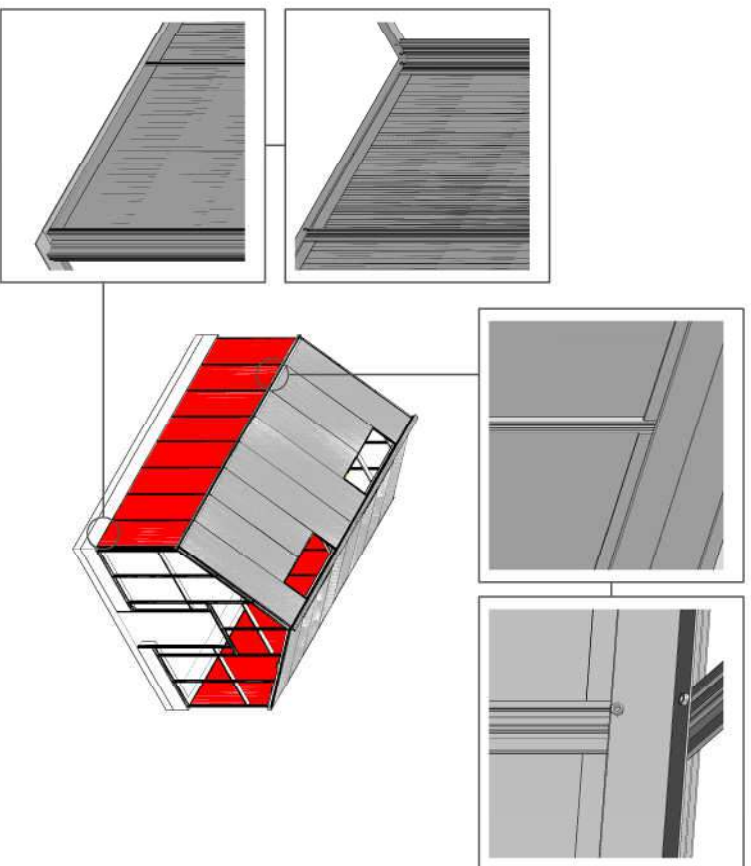





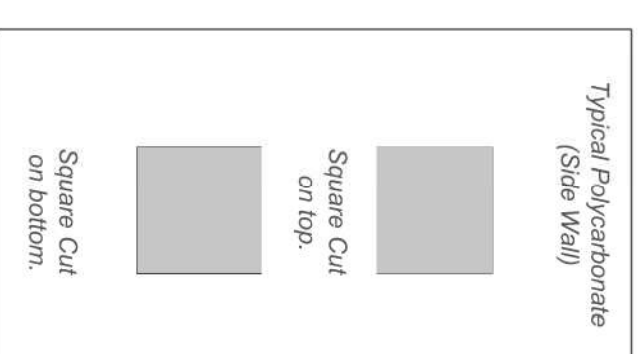

**PRO TIPS**

Start by glazing the 4 corners on the side walls of the greenhouse. This will help to square the frame from front to back. Don't be afraid to shift the Frame as necessary.



**Parts List:**

-  Glazing Caps
-  Glazing Caps (Ripped)
-  h-Channels (Top)
-  h-Channels (Bottom)
-  Swall Polycarbonate Panels
-  Setting Blocks
-  #8 x 3/4" S.S. Screws

**PRO TIPS**



All Glazing Caps are cut and punched so that the holes will line up horizontally if installed right side up.

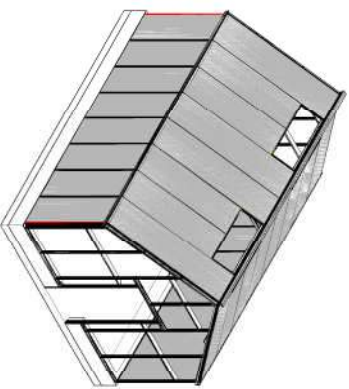

**STAGE 21C: SIDE WALL CORNER CAPS - (16MM 5WALL POLYCARBONATE)**

**STEPS:**

7. PRESS THE RIPPED CAP AGAINST THE GLAZING BAR & CORNER POST.
  8. SECURE THE CAP TO THE GLAZING BAR.
- REPEAT FOR ALL CORNERS  
CONTINUE ON NEXT PAGE

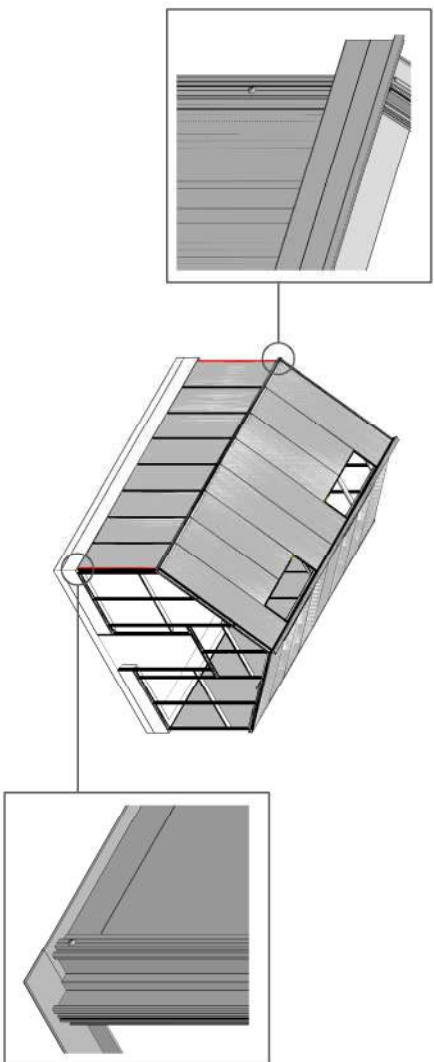
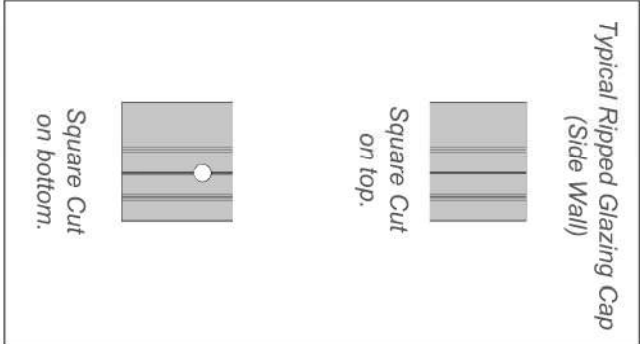
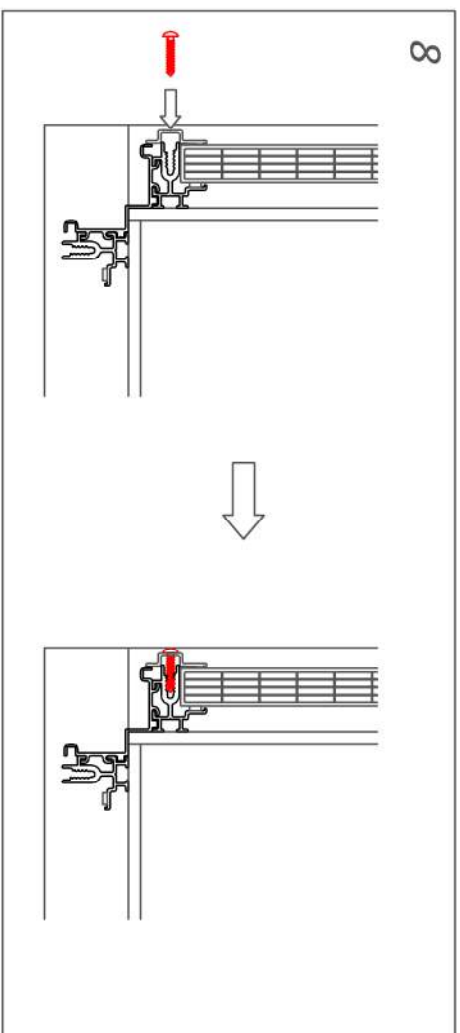
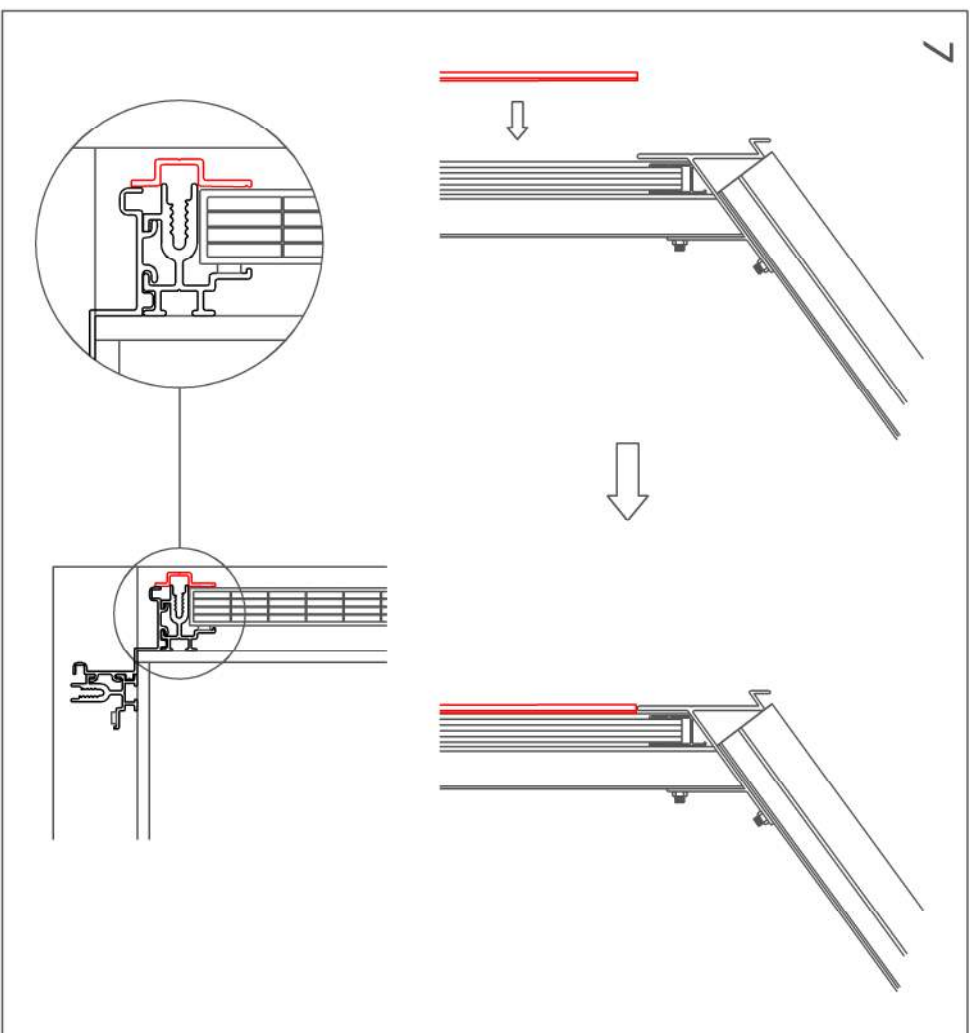

**Parts List:**

- Glazing Caps
- Glazing Caps (Ripped)
- h-Channels (Top)
- h-Channels (Bottom)
- 5wall Polycarbonate Panels
- Setting Blocks
- #8 x  $\frac{3}{4}$ " S.S. Screws

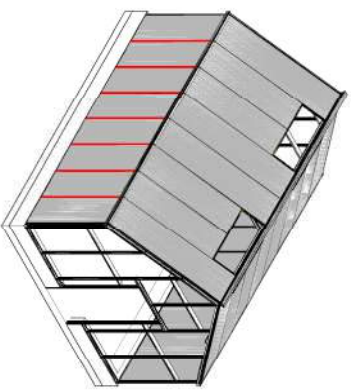

**STAGE 21D: SIDE WALL GLAZING -  
(16MM 5WALL POLYCARBONATE)**

**STEPS:**

- 9. PLACE THE CAP AGAINST THE POLYCARBONATE PANEL
  - 10. SECURE THE CAP TO THE GLAZING BAR.
- REPEAT FOR ALL REMAINING CAPS

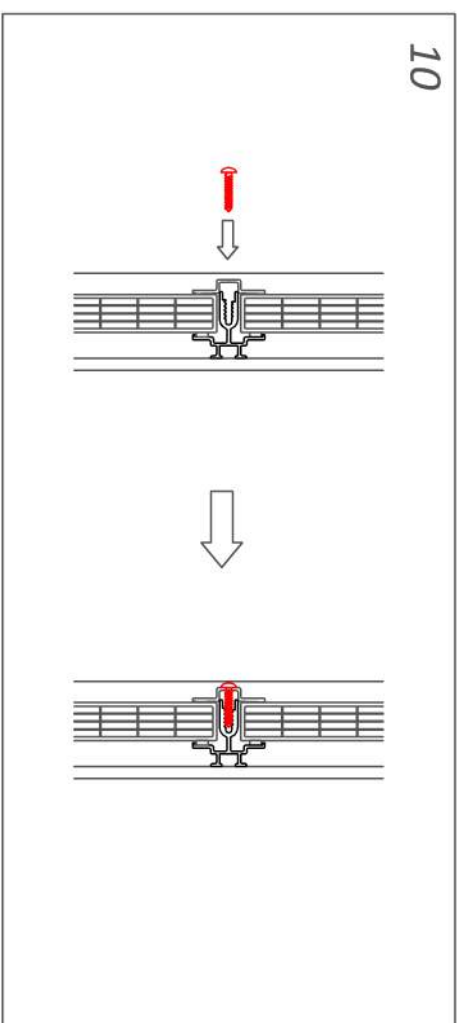
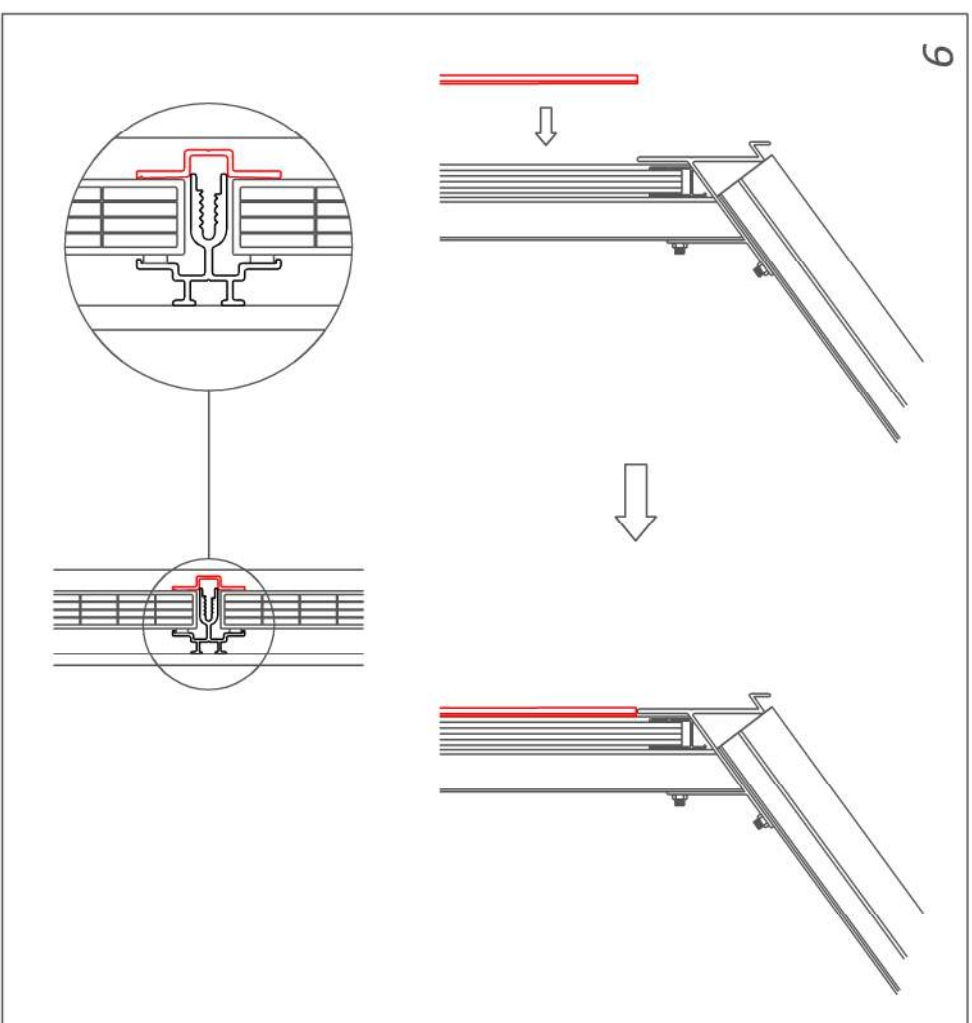
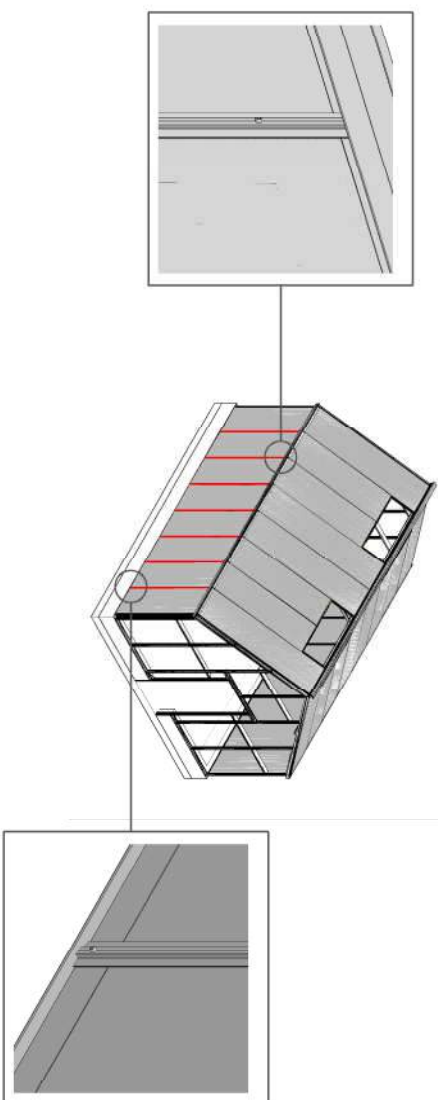





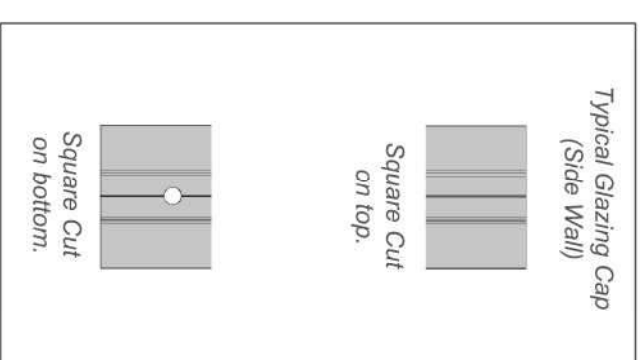

**PRO TIPS**

All Side Wall Caps should sit flush on top of the Base and be tight to the Gutter.



**Parts List:**

-  Glazing Caps
-  Glazing Caps (Ripped)
-  h-Channels (Top)
-  h-Channels (Bottom)
-  Swall Polycarbonate Panels
-  Setting Blocks
-  #8 x 3/4" S.S. Screws

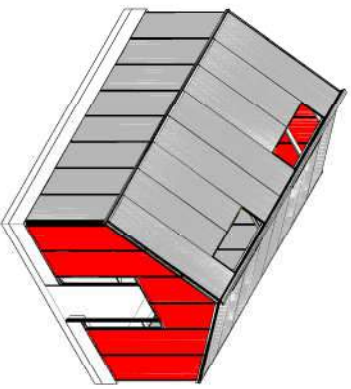





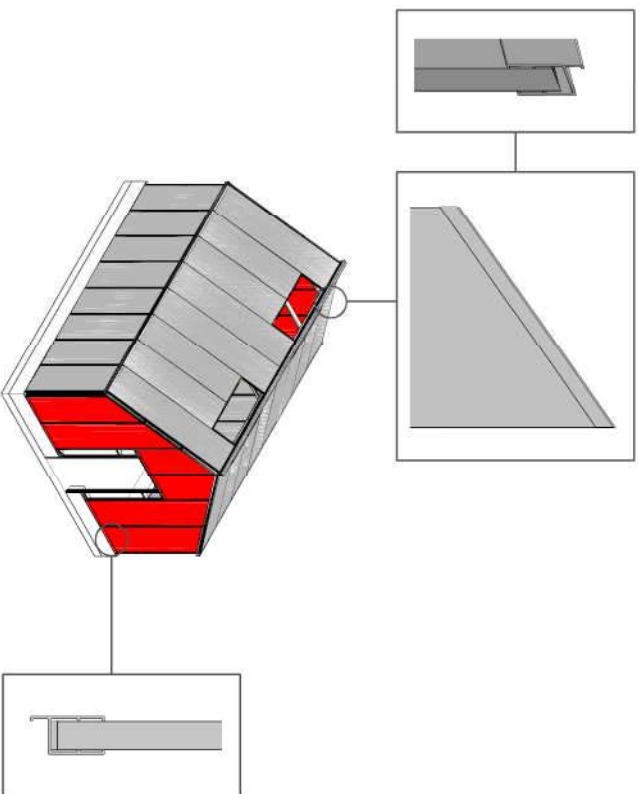

**STAGE 22A: GABLE GLAZING -  
(16MM 5WALL POLYCARBONATE)**

- STEPS:**
1. PEEL THE BROWN PAPER FROM THE FOAM TAPE ON THE SIDE WALL GLAZING BARS.
  2. PEEL THE FILM OFF BOTH SIDES OF THE POLYCARBONATE PANEL.
  3. PLACE THE H-CHANNELS & SETTING BLOCKS ONTO THE TOP & BOTTOM OF A POLYCARBONATE PANEL
- CONTINUE ON NEXT PAGE



**Parts List:**

-  Glazing Caps
-  Glazing Caps (Ripped)
-  h-Channels (Top)
-  h-Channels (Bottom)
-  Small Polycarbonate Panels
-  Setting Blocks
-  #8 x 3/4" S.S. Screws

Polycarbonate Panels, Glazing Caps & h-Channels will come packaged specific to their location in the greenhouse. Open the Bundles only as you need them.



**PRO TIPS**  
h-Channels for the top of the Polycarbonate are cut at angle on both ends to match the roof pitch of the greenhouse.

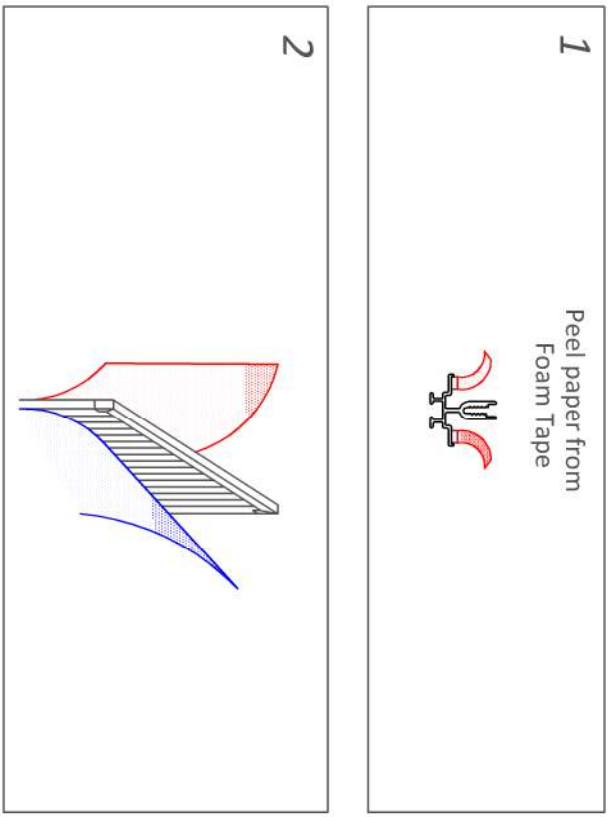

Typical Polycarbonate (Gable Wall)

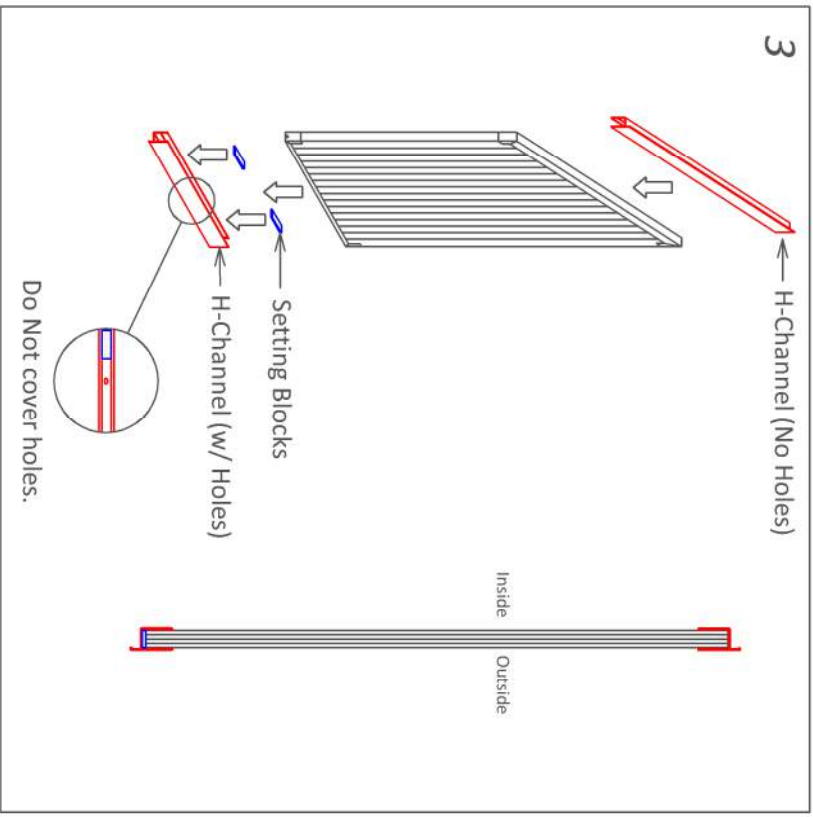

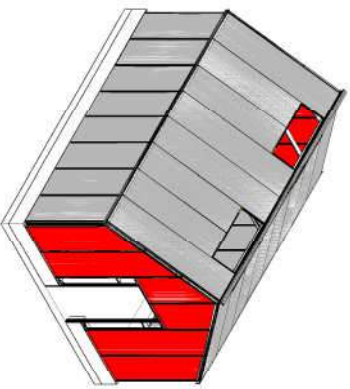

**STAGE 22B: GABLE GLAZING -  
(16MM SMALL POLYCARBONATE)**

**STEPS:**

4. SLIP THE TOP OF THE POLYCARBONATE PANEL BENEATH THE END RAFTER.
5. PUSH THE BOTTOM OF THE POLYCARBONATE PANEL INTO POSITION.
6. PUSH THE TOP H-CHANNEL UP UNTIL IT TOUCHES THE UNDERSIDE OF THE END RAFTER.

REPEAT FOR ALL ANGLE-CUT GABLE GLAZING



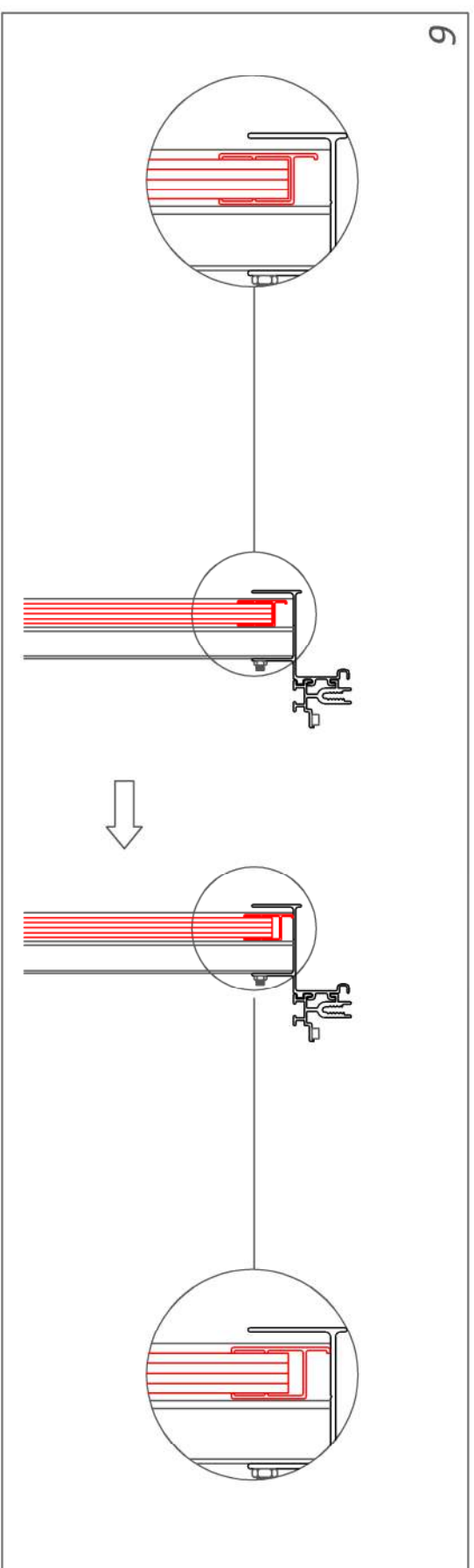
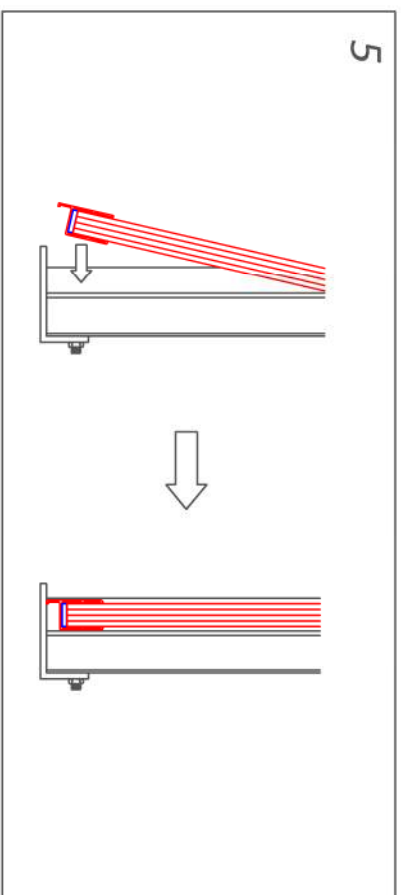
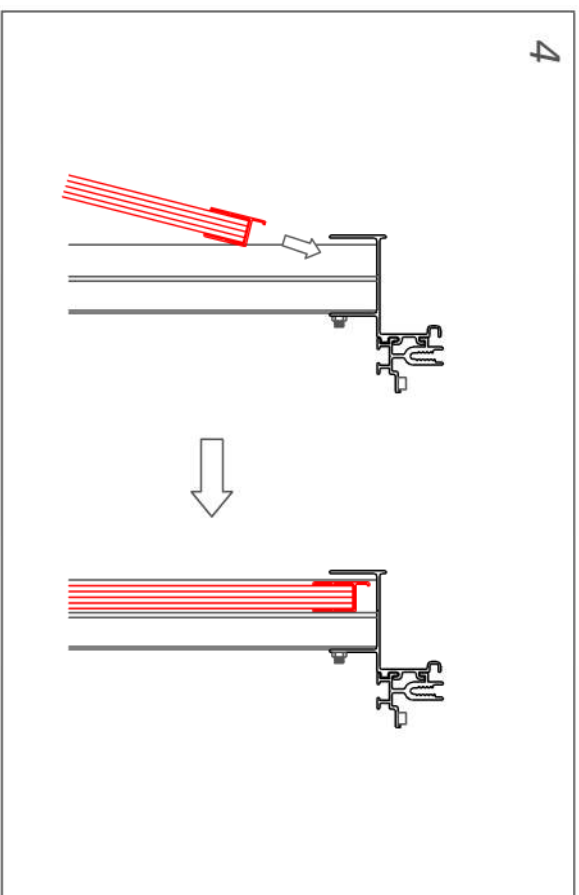
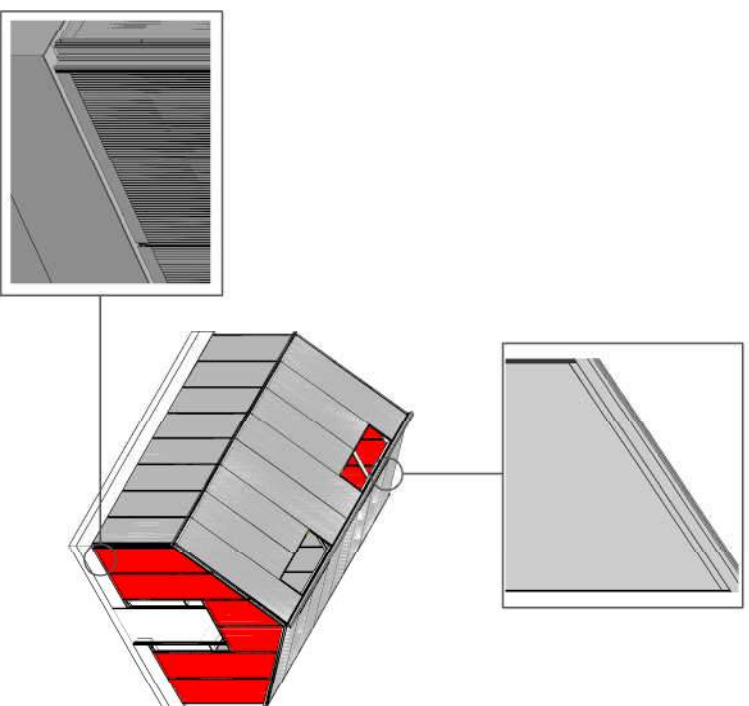



CONTINUE ON NEXT PAGE



**PRO TIPS**

Start by glazing the 4 corners on the gable walls of the greenhouse. This will help to square the frame from left to right.

**Parts List:**

-  Glazing Caps
-  Glazing Caps (Ripped)
-  h-Channels (Top)
-  h-Channels (Bottom)
-  Small Polycarbonate Panels
-  Setting Blocks
-  #8 x 3/4" S.S. Screws



**PRO TIPS**



The Long h-Channels for this step were packaged with the rest of the Door Frame installed during Stage 3 of the Assembly process.

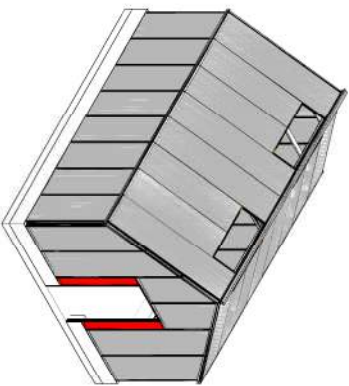

**STAGE 22C: BESIDE DOOR GLAZING - (16MM SMALL POLYCARBONATE)**

**STEPS:**

7. PLACE THE H-CHANNELS ONTO THE TOP, BOTTOM & ONE SIDE OF THE NARROW POLYCARBONATE PANELS INTENDED FOR BESIDE THE DOOR.
  8. FILL THE GAP BETWEEN THE BASE AND THE DOOR FRAME WITH CAULKING.
  9. SLIP THE LONG H-CHANNELS INTO THE TRACK ON THE SIDE OF THE DOOR FRAME & ROTATE INTO POSITION.
  10. PUSH THE TOP H-CHANNEL UP UNTIL IT TOUCHES THE BOTTOM OF THE DOOR HEADER.
- CONTINUE ON NEXT PAGE

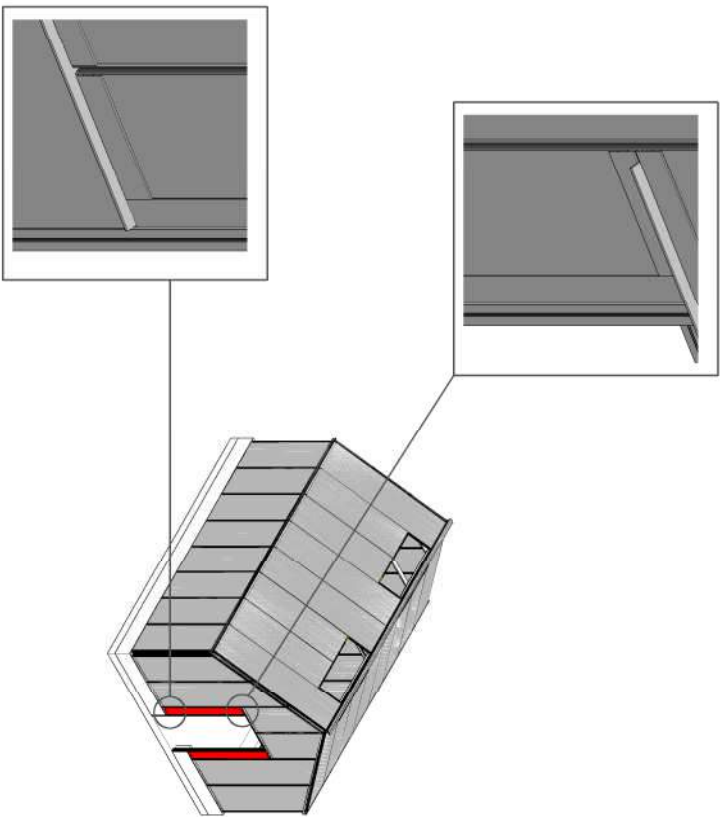
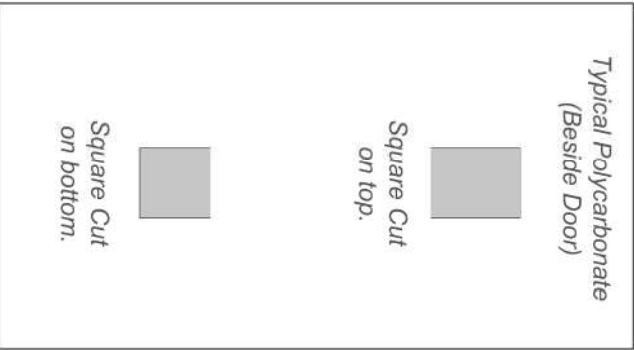
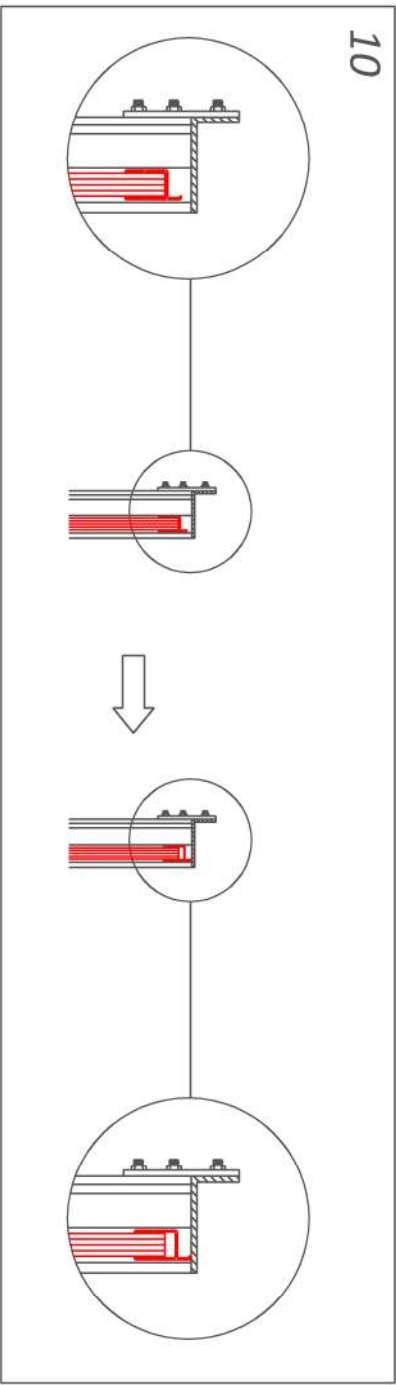
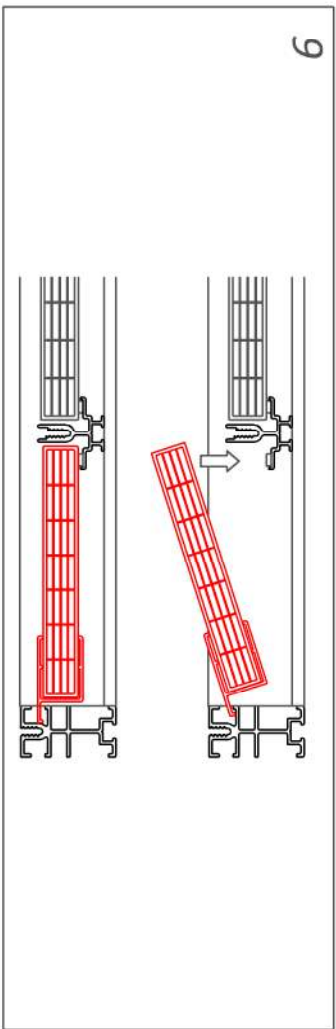
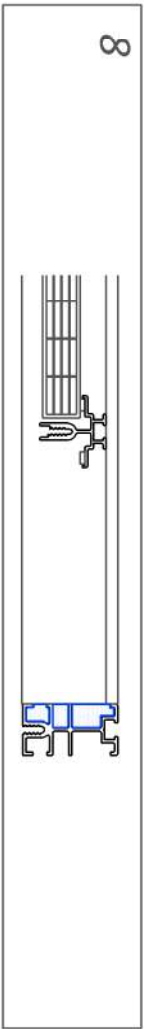
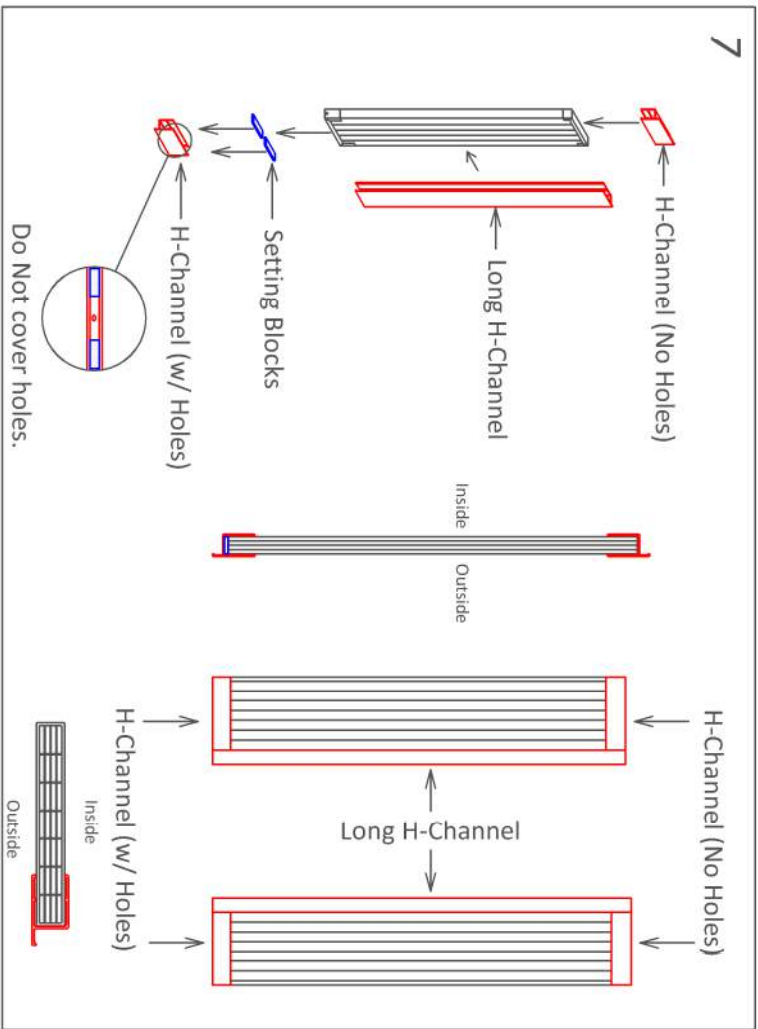

**Parts List:**

- 
- 
- 
- 
- 
- 
- 
-

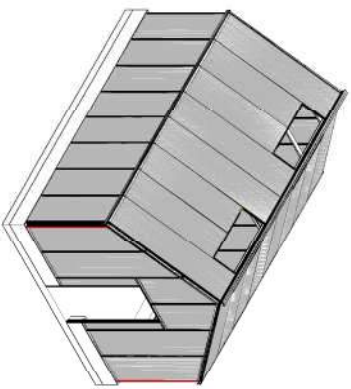

**STAGE 22D: GABLE CORNER CAPS -  
(16MM 5WALL POLYCARBONATE)**

**STEPS:**





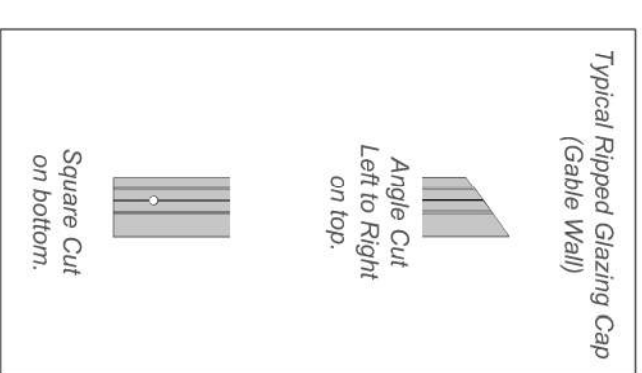
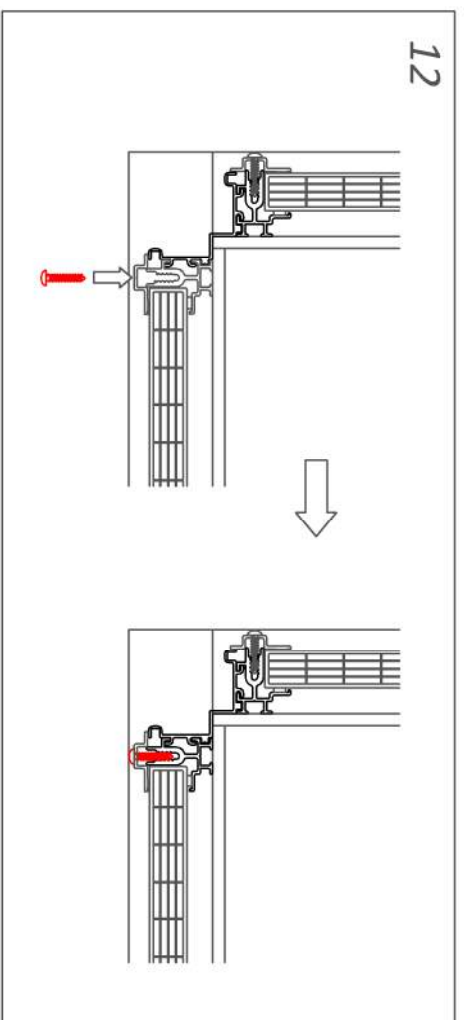
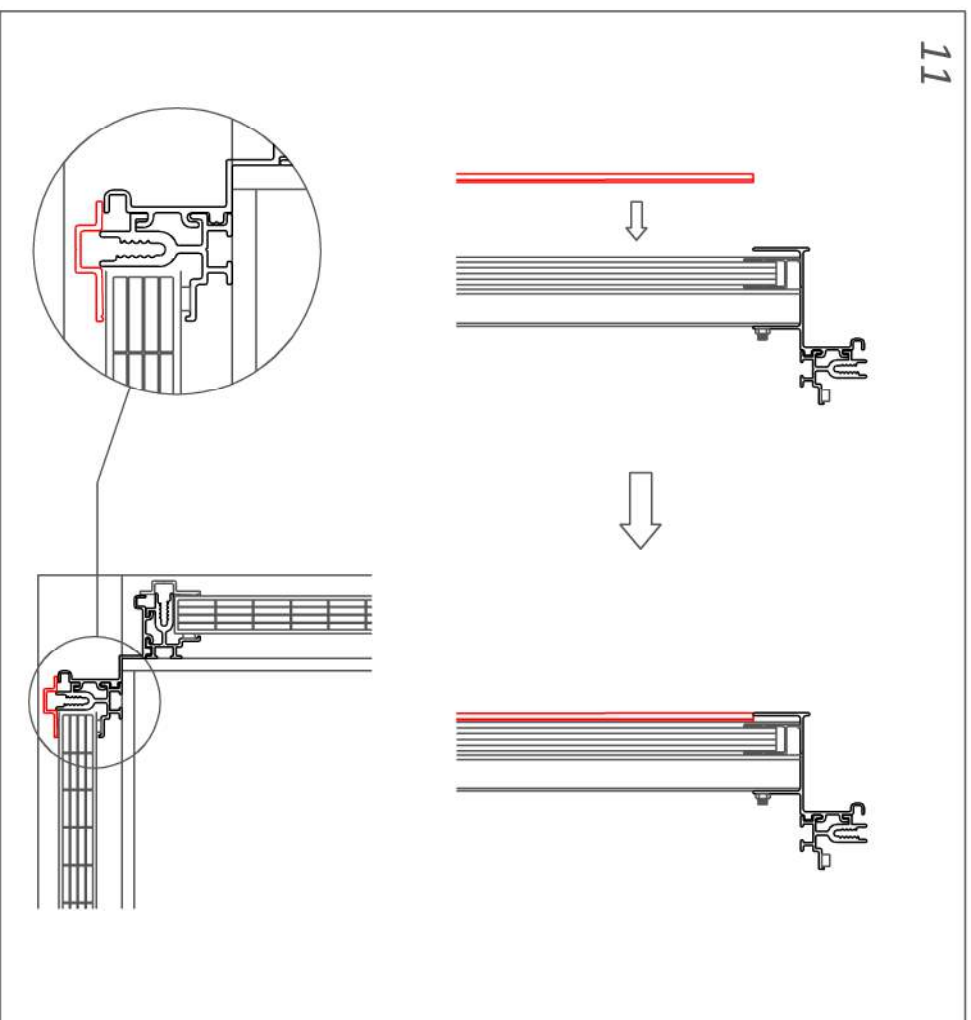
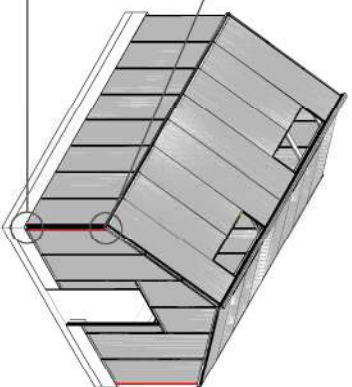
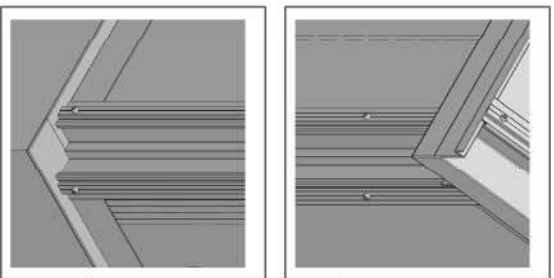

11. PRESS THE RIPPED CAP AGAINST THE GLAZING BAR & CORNER POST.
12. SECURE THE CAP TO THE GLAZING BAR.

REPEAT FOR ALL CORNERS

CONTINUE ON NEXT PAGE



**Parts List:**

-  Glazing Caps
-  Glazing Caps (Ripped)
-  h-Channels (Top)
-  h-Channels (Bottom)
-  Small Polycarbonate Panels
-  Setting Blocks
-  #8 x  $\frac{3}{4}$ " S.S. Screws

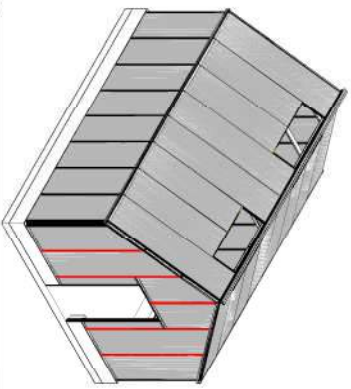





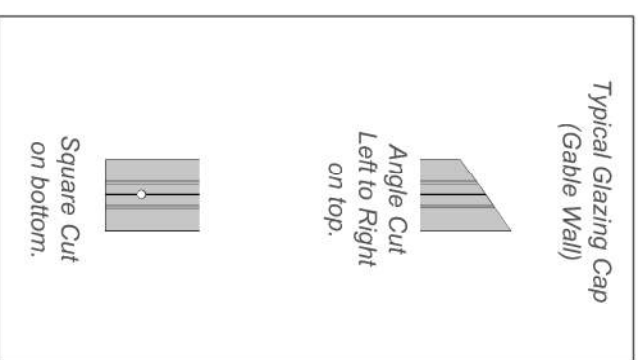
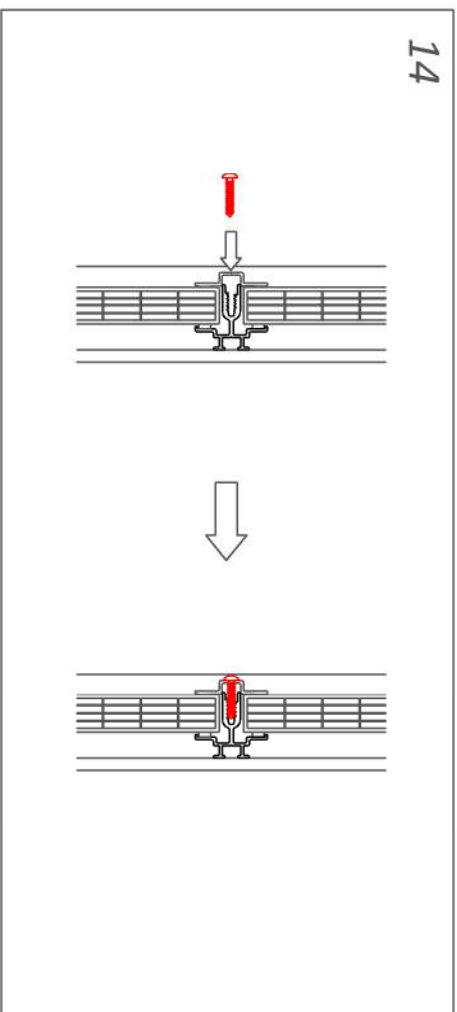
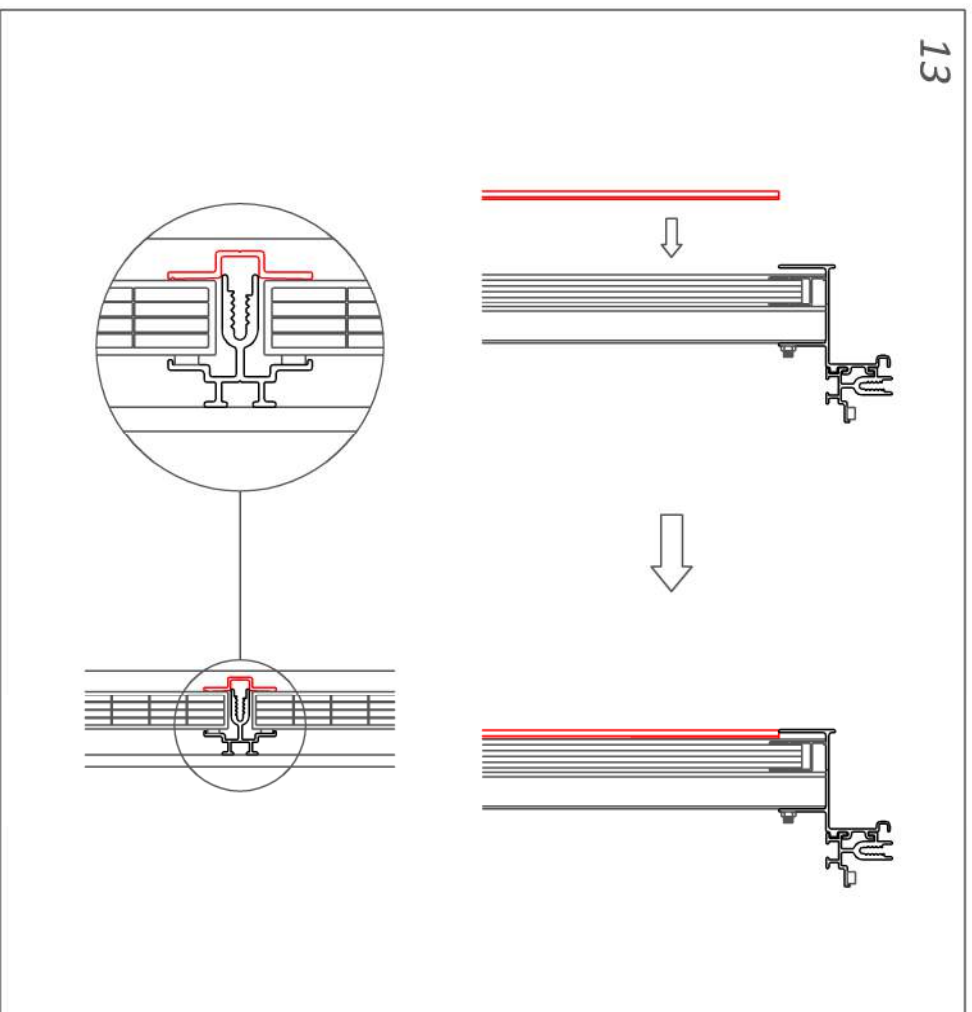
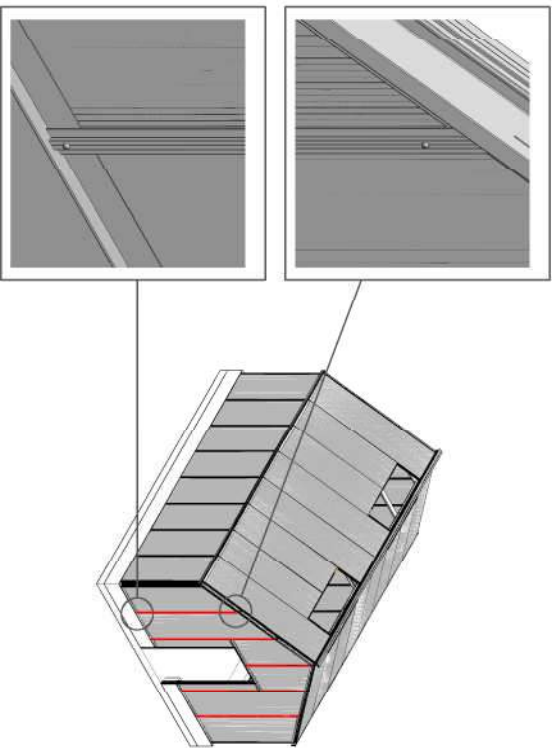

**STAGE 22E: GABLE CAPS -  
(16MM 5WALL POLYCARBONATE)**

STEPS:

13. PRESS THE CAP AGAINST THE GLAZING BAR.
  14. SECURE THE CAP TO THE GLAZING BAR.
- REPEAT FOR ALL REMAINING CAPS



Parts List:

-  Glazing Caps
-  Glazing Caps (Ripped)
-  h-Channels (Top)
-  h-Channels (Bottom)
-  Swall Polycarbonate Panels
-  Setting Blocks
-  #8 x  $\frac{3}{4}$ " S.S. Screws

**STAGE 23: SEALING -  
(16MM 5WALL POLYCARBONATE)**

- CLEAR SILICONE (PROGLAZE)
- COLORED CAULKING (TREMCO 830)

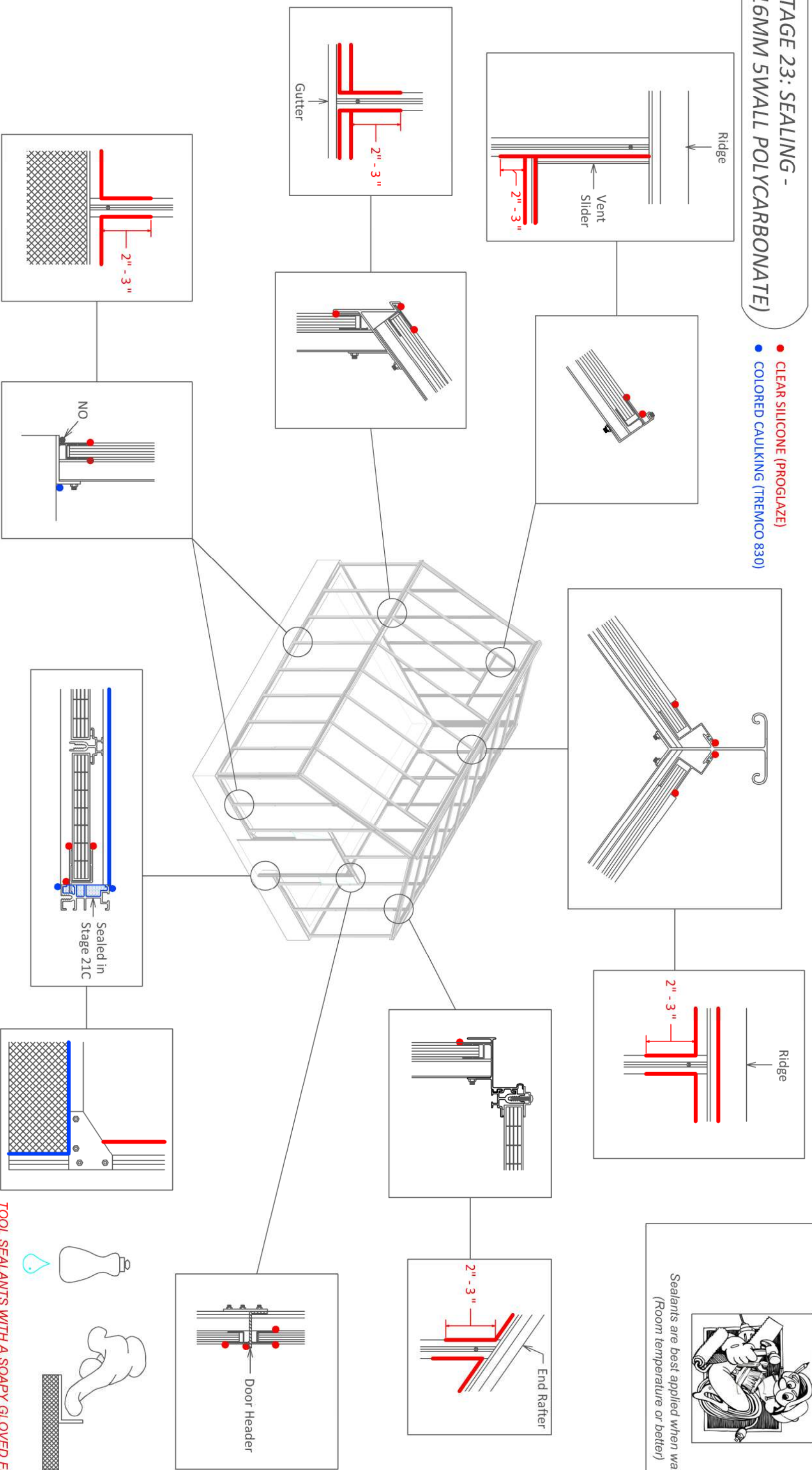

**TOOL SEALANTS WITH A SOAPY GLOVED FINGER OR A CAULK-SMOOTHING TOOL.**

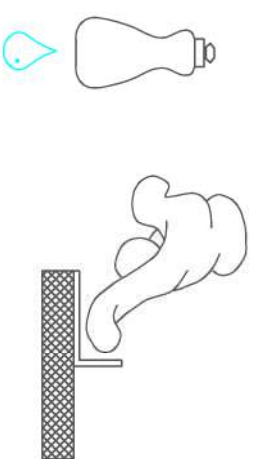

**Parts List:**

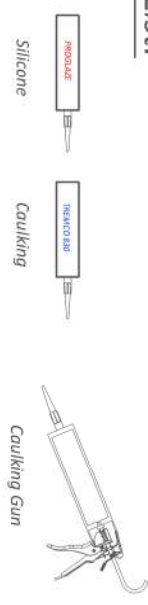

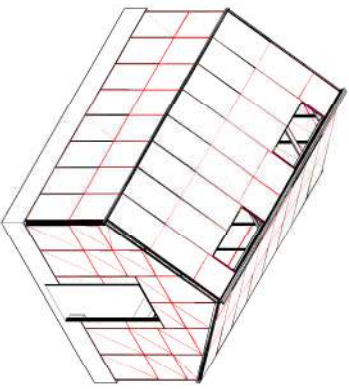

**STAGE 24: GLASS OVERLAPS  
(3MM TEMPERED SINGLE GLASS)**

**\*WARNINGS\***  
**- DO NOT USE A CORDLESS DRILL DURING THIS STAGE-  
OVER-TIGHTENING THE SCREWS CAN  
CAUSE THE GLASS TO SHATTER**

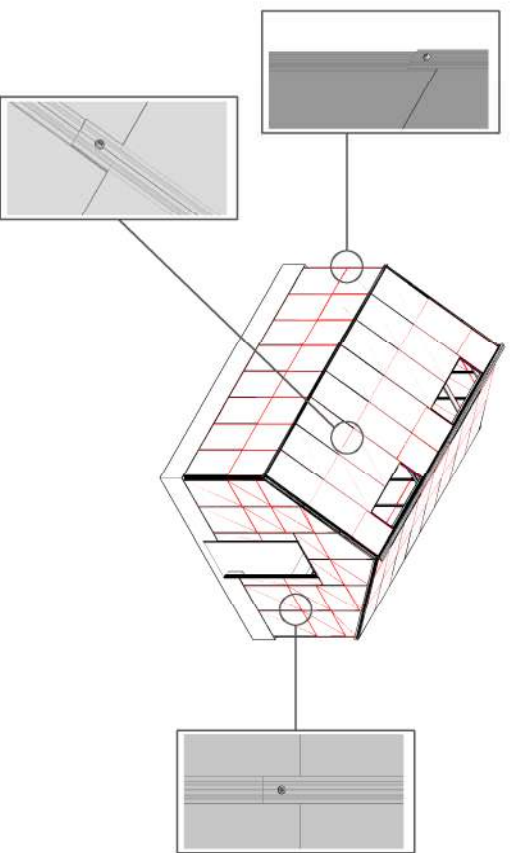

**Parts List:**

-  Glazing Caps
-  3mm Tempered Glass Panels
-  #8 x  $\frac{3}{4}$ " S.S. Screws

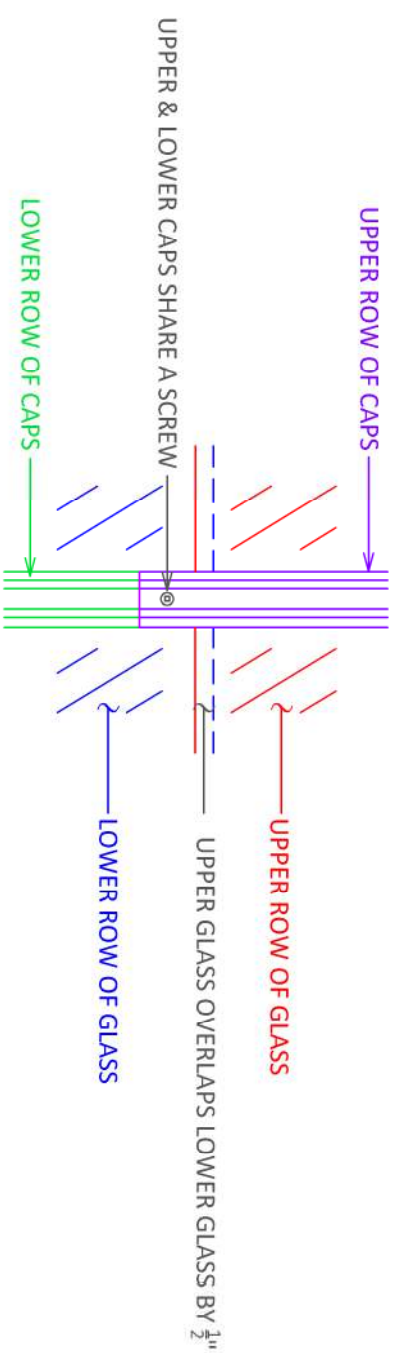
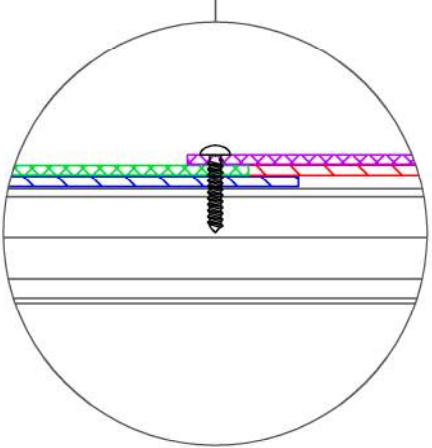
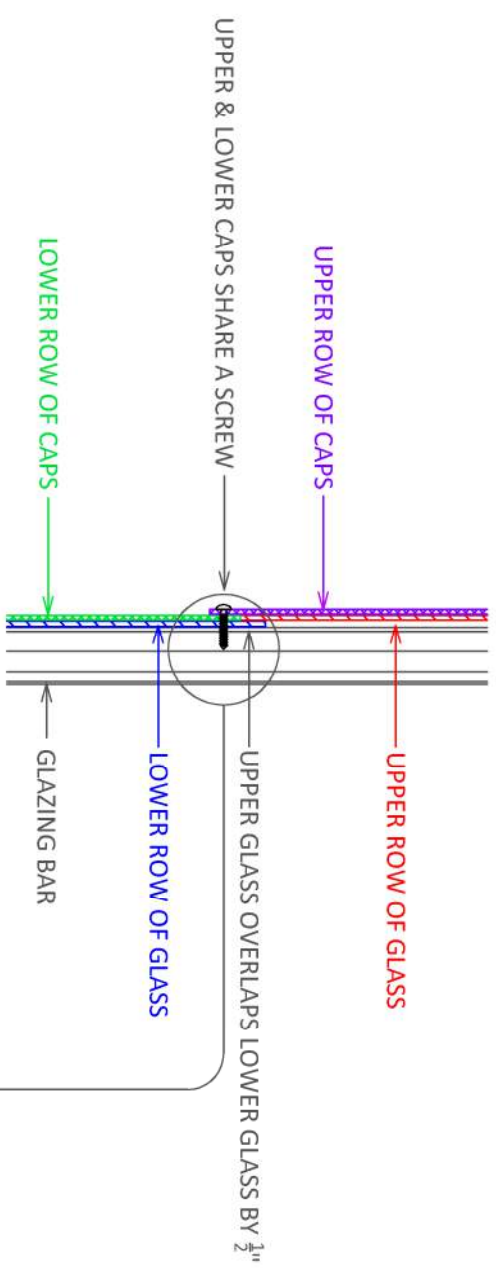

**PRO TIPS**



The only place that the glass won't overlap is the narrow pieces beside a storm door.

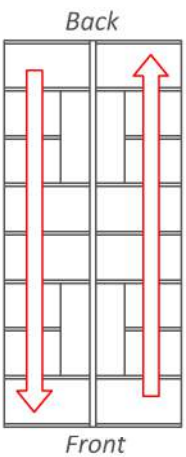
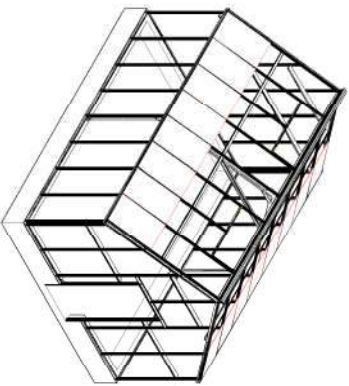

GLAZE & CAP THE ROOF IN ORDER FROM BACK TO FRONT AND THEN FRONT TO BACK. ONE ROW OF GLASS AT A TIME. COMPLETE ONE SIDE BEFORE BEGINNING THE NEXT.

### STAGE 25A: ROOF GLAZING - (3MM TEMPERED SINGLE GLASS)

**STEPS:**

1. PEEL THE BROWN PAPER FROM THE FOAM TAPE ON THE GABLE GLAZING BARS.
2. STARTING IN EITHER CORNER, REST THE FIRST GLASS PANEL IN THE GUTTER, LOWER ONTO THE ROOF GLAZING BAR AND PRESS AGAINST THE FOAM TAPE.
3. ATTACH THE FIRST GLASS CAP TO THE END RAFTER WITH  $\frac{3}{4}$ " #8 SCREWS.

REPEAT FOR ENTIRE BOTTOM ROW OF ROOF GLASS.

CONTINUE ON NEXT PAGE

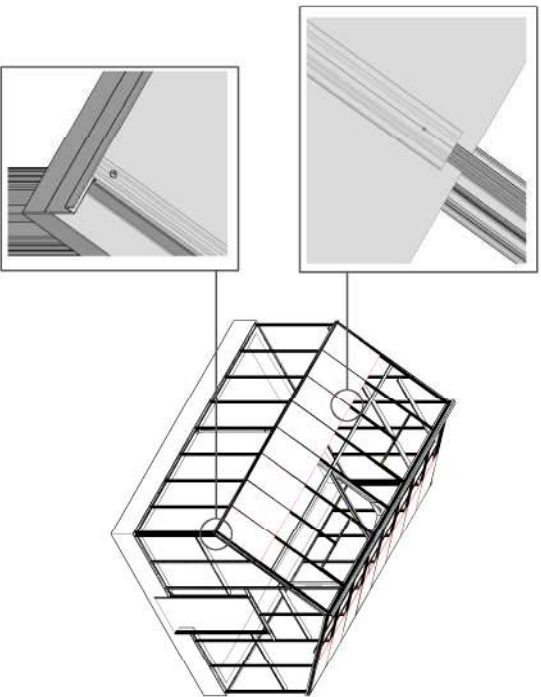

1

Peel paper from Foam Tape



2

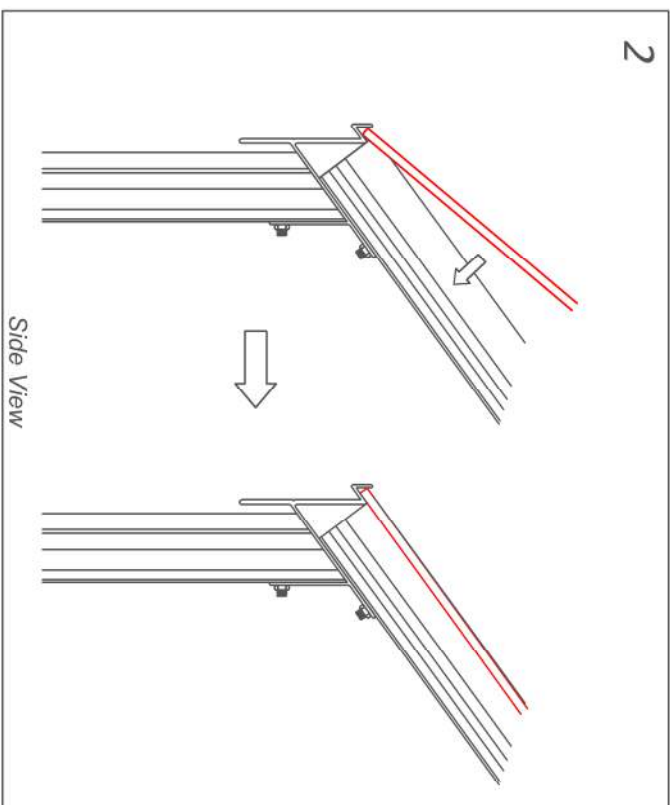

Side View

LEAVE THIS HOLE EMPTY.

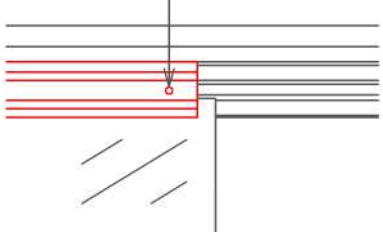

### PRO TIPS



Your Greenhouse will come with a Glass Map showing you the location and dimensions of every piece of glass and cap.

3

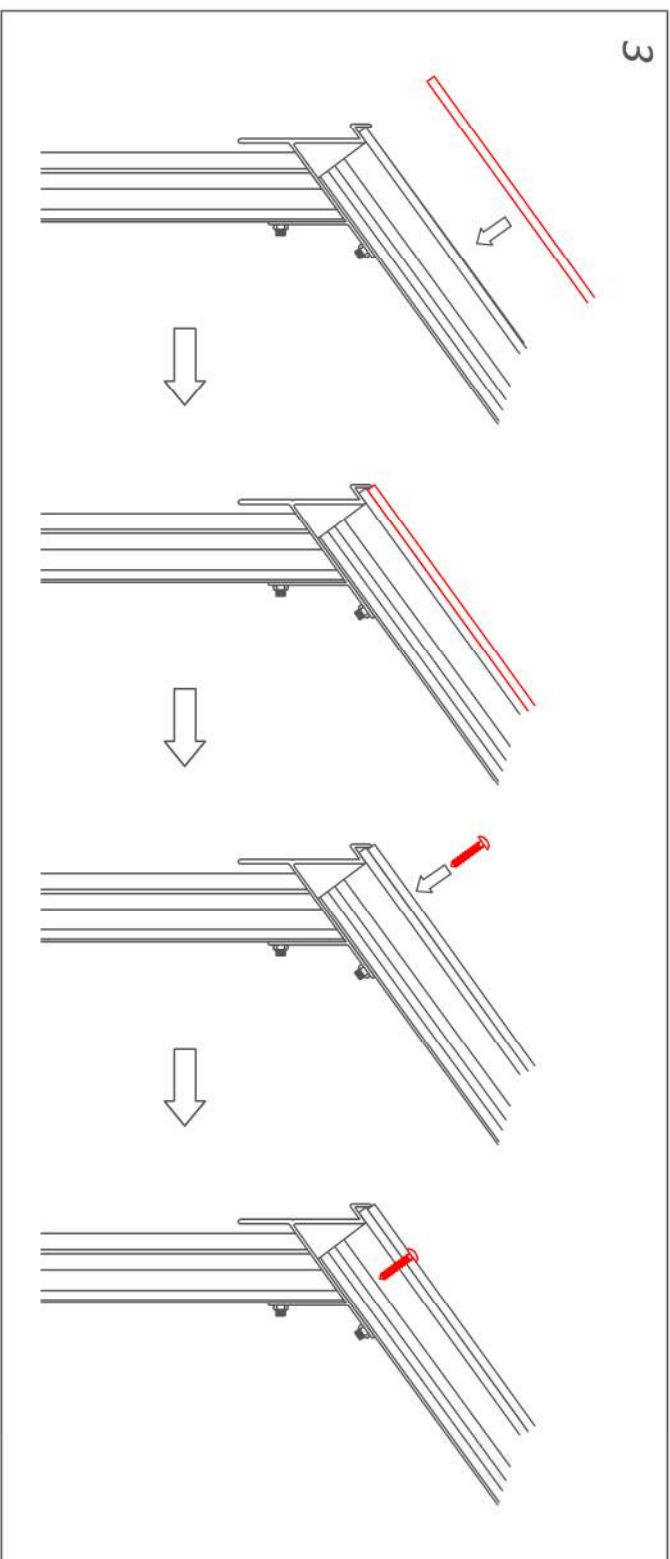

**Parts List:**



Glazing Caps



3mm Tempered Glass Panels



#8 x  $\frac{3}{4}$ " S.S. Screws

PRO TIPS



Your Greenhouse will come with a Glass Map showing you the location and dimensions of every piece of glass and the cap.

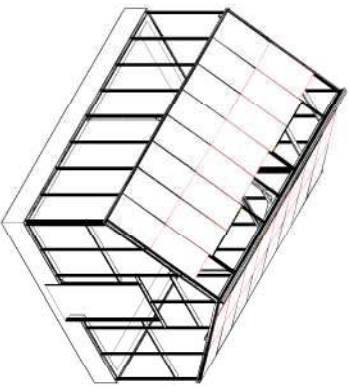

STAGE 25B: ROOF GLAZING - (3MM TEMPERED SINGLE GLASS)

- STEPS:**
4. STARTING AT ONE END, REST THE NEXT ROW OF GLASS PANELS ON TOP OF THE CAPS BELOW AND PRESS TIGHT AGAINST THE GLAZING FOAM
  5. SET THE NEXT CAP IN PLACE SO THAT THE TOP & BOTTOM HOLES OVERLAP
  6. SECURE THE CAP WITH 3/8" #8 SCREWS LEAVING THE TOP HOLE ON THE CAP EMPTY
- REPEAT FOR ALL REMAINING ROWS OF GLASS OTHER THAN THE TOP ROW  
CONTINUE ON NEXT PAGE

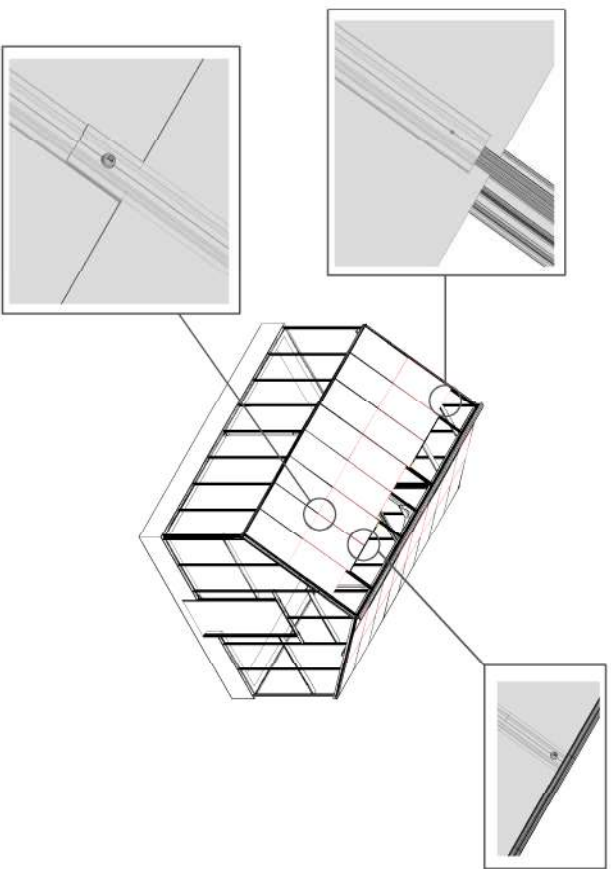
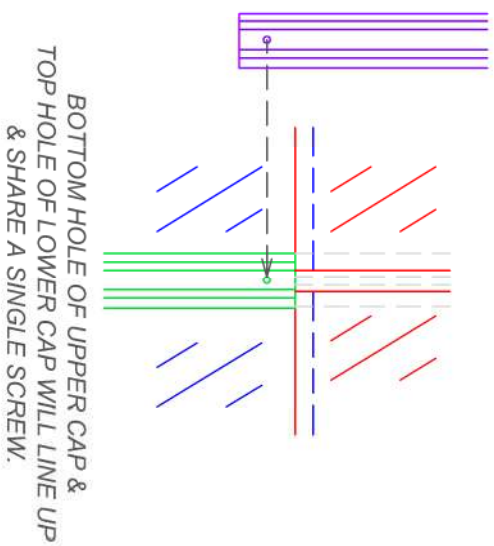
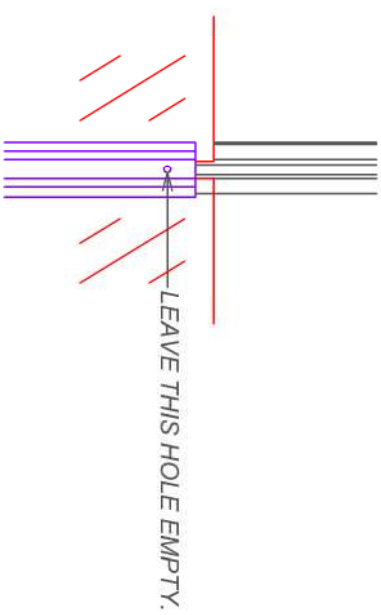
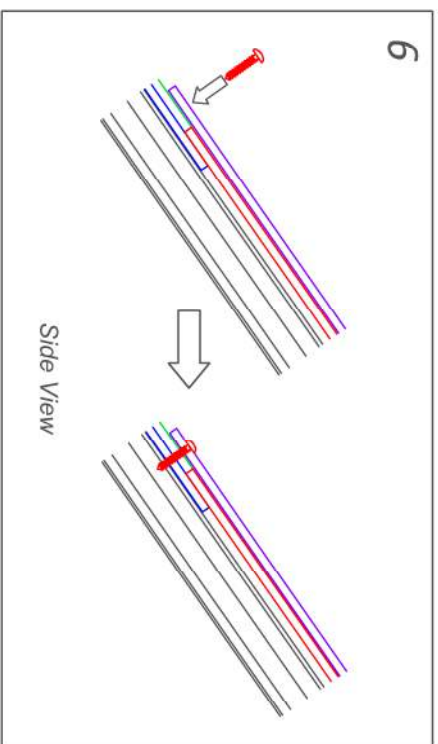
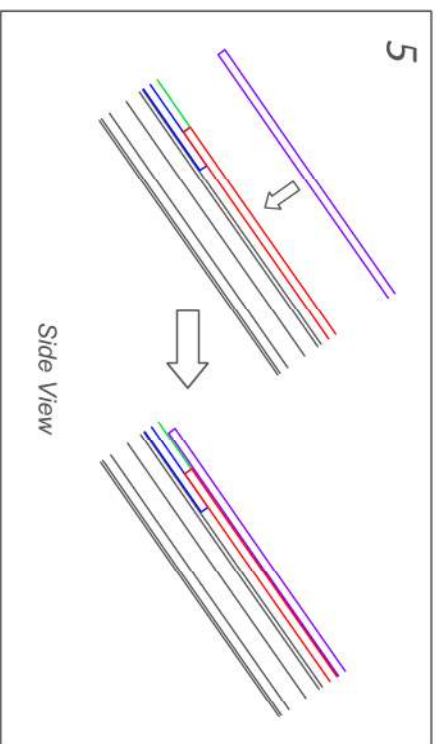
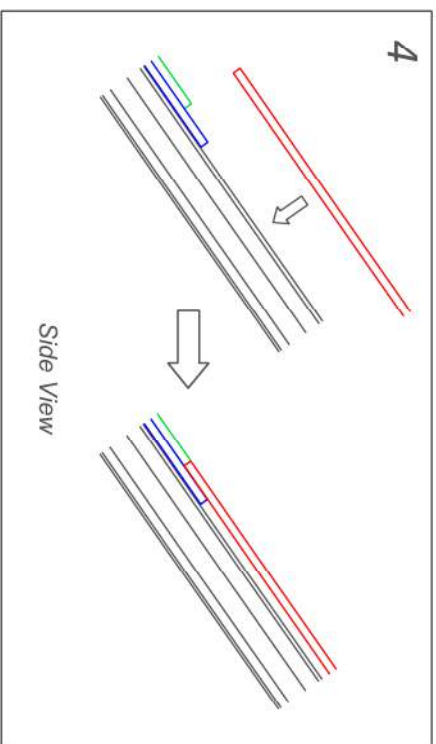

Parts List:

-  Glazing Caps
-  3mm Tempered Glass Panels
-  #8 x 3/8" S.S. Screws

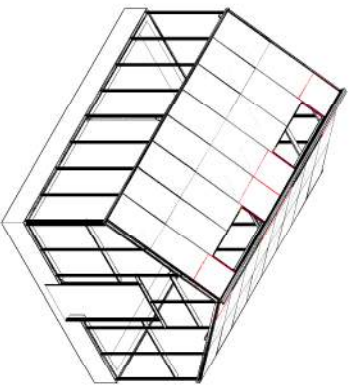

**STAGE 25C: ROOF GLAZING -  
(3MM TEMPERED SINGLE GLASS)**

- STEPS:**
7. STARTING AT ONE END, REST THE NEXT ROW OF GLASS PANELS ON TOP OF THE CAPS BELOW AND PRESS TIGHT AGAINST THE GLAZING FOAM.
  8. SLIP THE TOP OF THE NEXT CAP BENEATH THE RIDGE AND SET IN PLACE SO THAT THE TOP & BOTTOM HOLES OVERLAP.
  9. SECURE THE CAP WITH 3/8" #8 SCREWS.

REPEAT FOR REMAINING PIECES IN THE TOP ROW OF ROOF GLASS

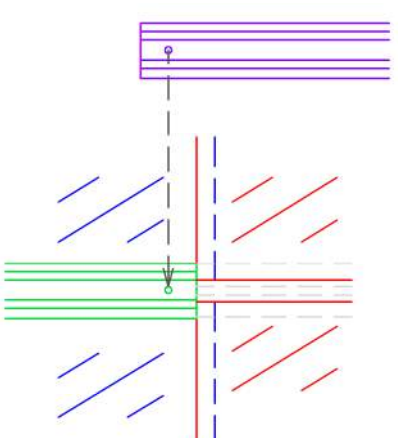
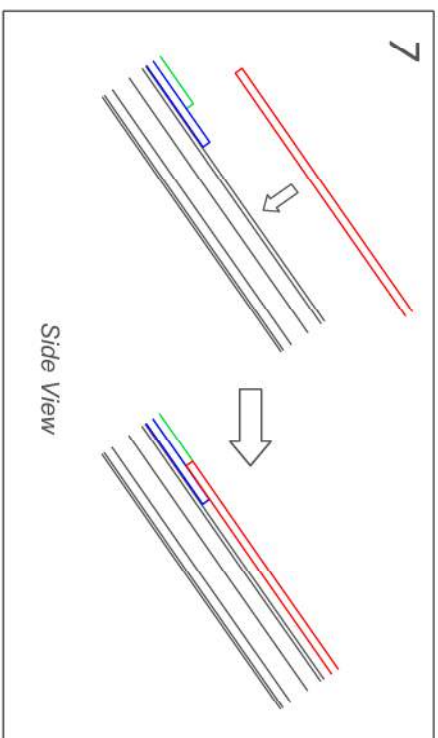
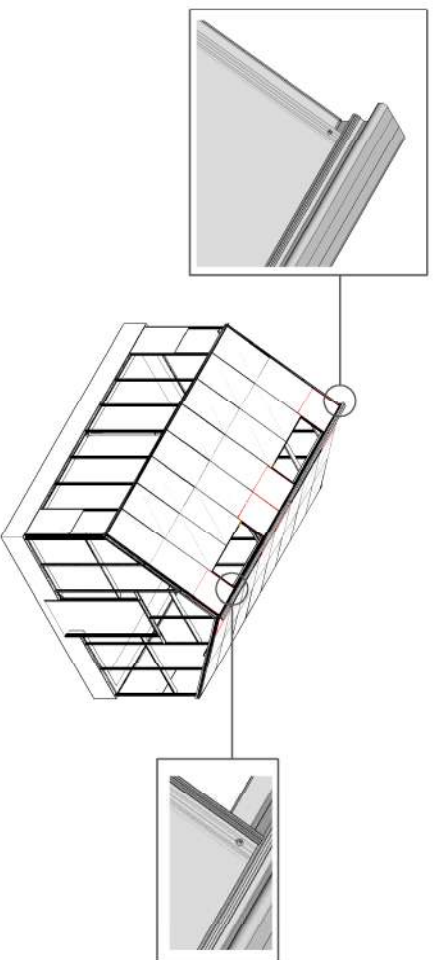

BOTTOM HOLE OF UPPER CAP &  
TOP HOLE OF LOWER CAP WILL LINE UP  
& SHARE A SINGLE SCREW.

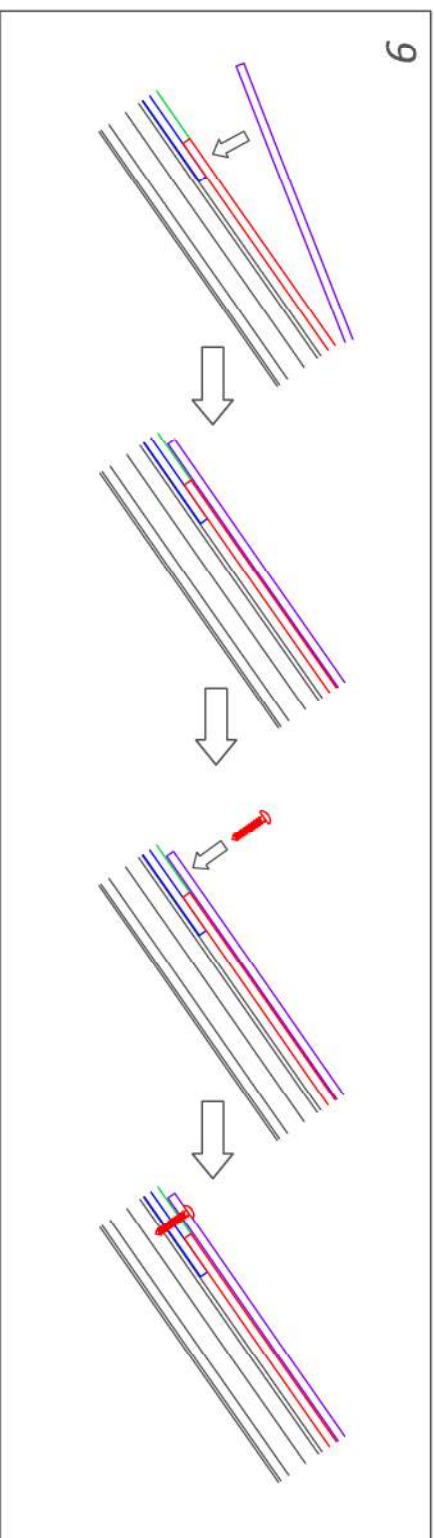
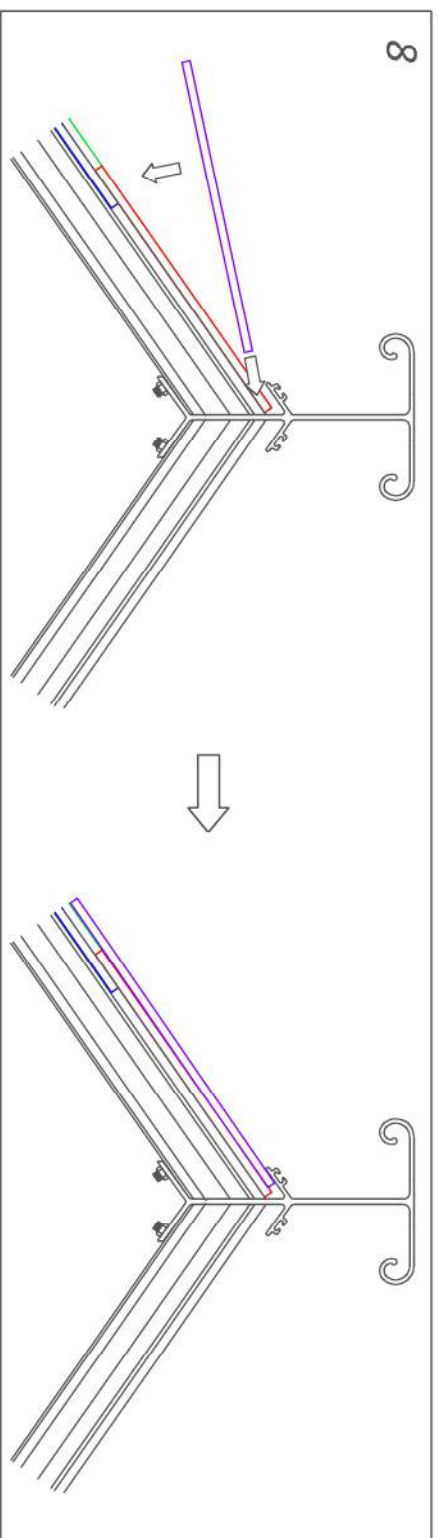

**Parts List:**

-  Glazing Caps
-  3mm Tempered Glass Panels
-  #8 x 3/8" S.S. Screws



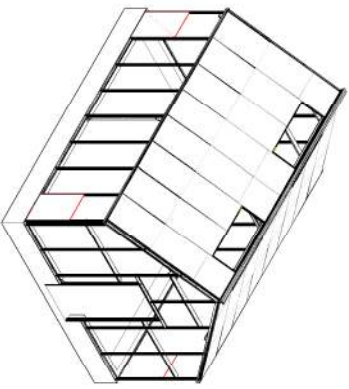

**STAGE 26A: SIDE WALL GLAZING -  
(3MM TEMPERED SINGLE GLASS)**

- STEPS:**
1. PEEL THE BROWN PAPER FROM THE FOAM TAPE ON THE SIDE WALL GLAZING BARS.
  2. INSTALL THE FIRST GLASS PANEL IN ANY SIDE WALL CORNER AND PRESS TIGHT AGAINST THE FOAM TAPE.
  3. ATTACH THE GLASS CAP TO THE CORNER POST ONLY WITH  $\frac{3}{4}$ " #8 SCREWS.

REPEAT FOR REMAINING SIDE WALL CORNERS

CONTINUE ON NEXT PAGE

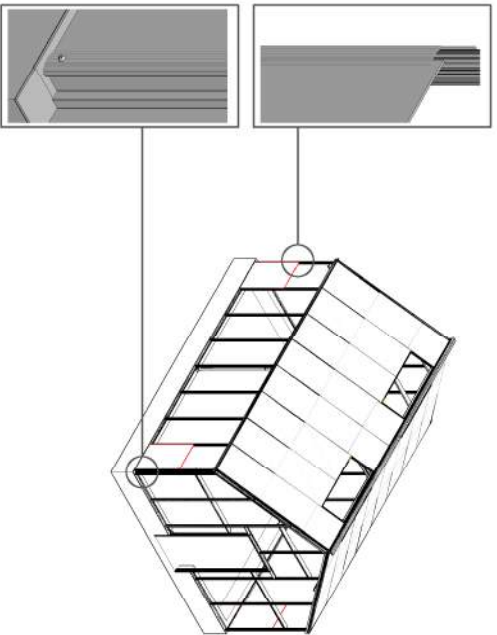

1

Peel paper from  
Foam Tape



2

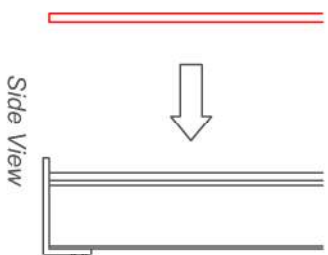

Side View

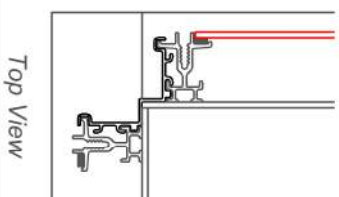

Top View

3

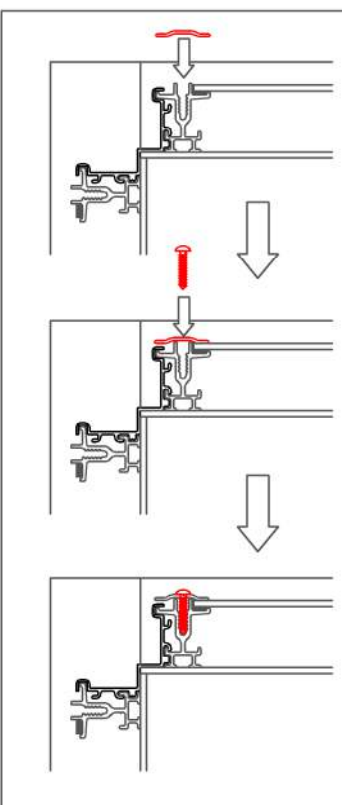

Your Greenhouse will come with a Glass Map showing you the location and dimensions of every piece of glass and cap.



**PRO TIPS**

LEAVE THIS HOLE EMPTY.

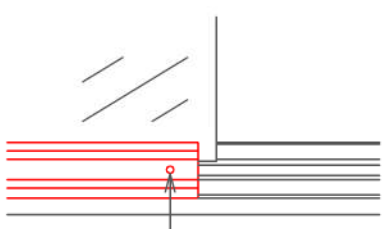

**Parts List:**

Glazing Caps



3mm Tempered Glass Panels



#8 x  $\frac{3}{4}$ " S.S. Screws



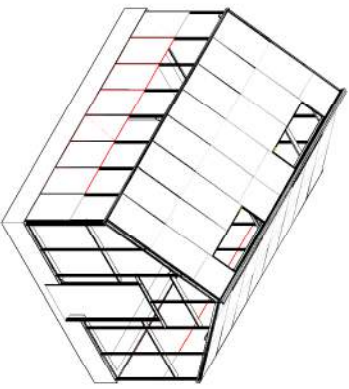

**STAGE 26B: SIDE WALL GLAZING -  
(3MM TEMPERED SINGLE GLASS)**

**STEPS:**

- 4. INSTALL THE REMAINING GLASS PANELS IN THE BOTTOM ROW OF SIDE WALL GLASS.
- 5. ATTACH THE REMAINING GLASS CAPS TO THE BOTTOM ROW OF GLASS.

REPEAT FOR ENTIRE BOTTOM ROW OF SIDE WALL GLASS

CONTINUE ON NEXT PAGE

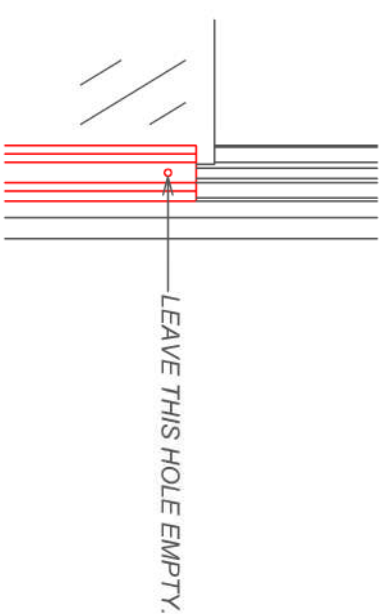
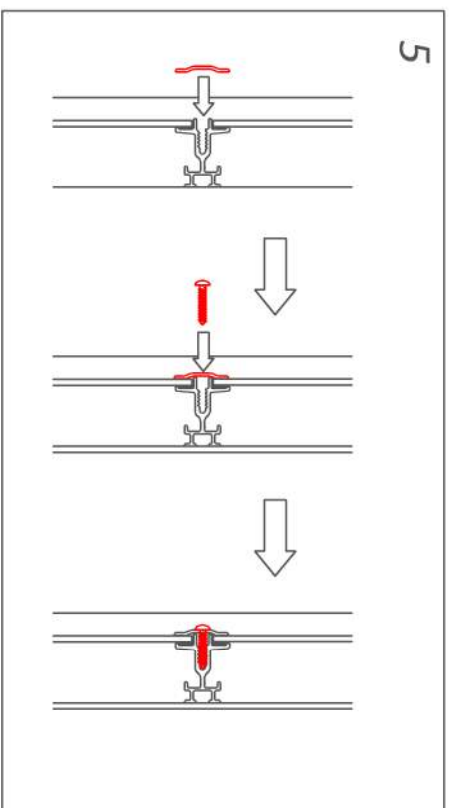
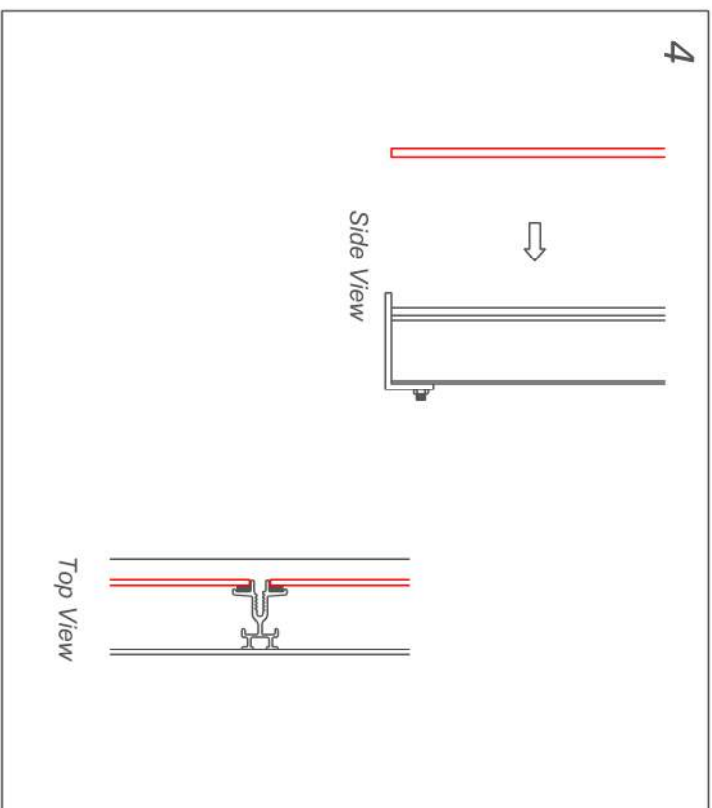
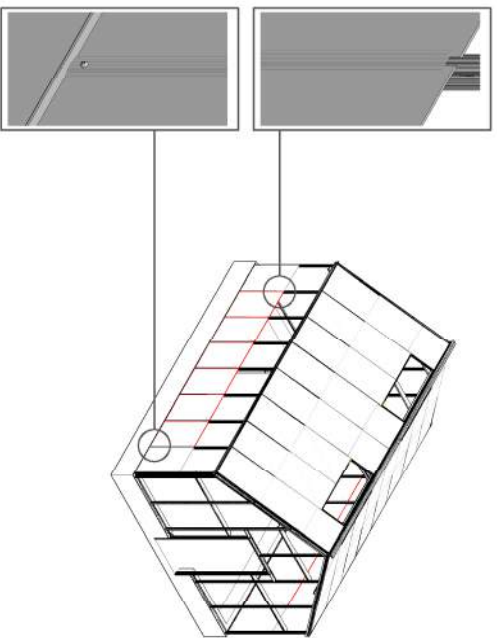

**PRO TIPS**

Do not over-tighten the screws. You want to make the screw snug plus a quarter turn.

**Parts List:**

Glazing Caps



3mm Tempered Glass Panels



#8 x 3/4" S.S. Screws



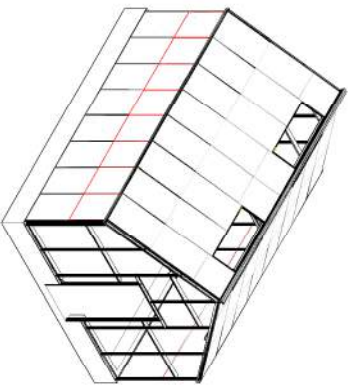

### STAGE 26C: GLASS OVERLAPS (3MM TEMPERED SINGLE GLASS)

**STEPS:**

- 6. STARTING AT ONE END, TUCK THE TOP OF THE GLASS PANEL BENEATH THE GUTTER...
- 7. REST THE GLASS PANEL ON TOP OF THE CAP BELOW AND PRESS TIGHT AGAINST THE FOAM TAPE.
- 8. SLIP THE FIRST CAP BENEATH THE GUTTER AND LINE IT UP SO THAT THE BOTTOM HOLE LINES UP WITH THE TOP HOLE ON THE CAP BELOW.

SECURE CAPS WITH  $\frac{3}{4}$ " #8 SCREWS

REPEAT FOR ENTIRE TOP ROW OF SIDE WALL GLASS

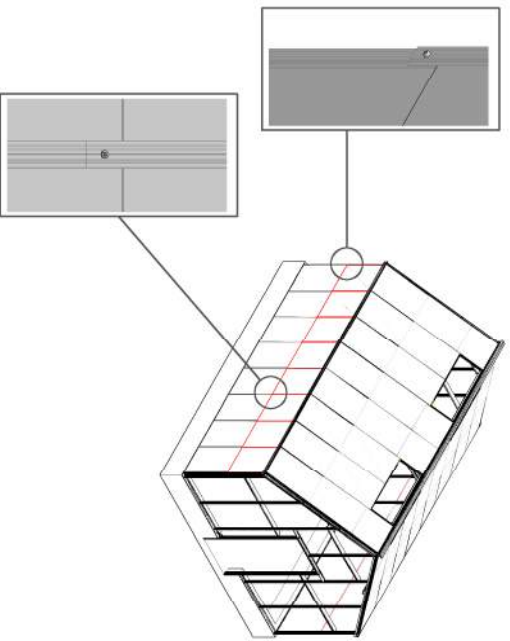

**Parts List:**

Glazing Caps

3mm Tempered Glass Panels

#8 x  $\frac{3}{4}$ " S.S. Screws

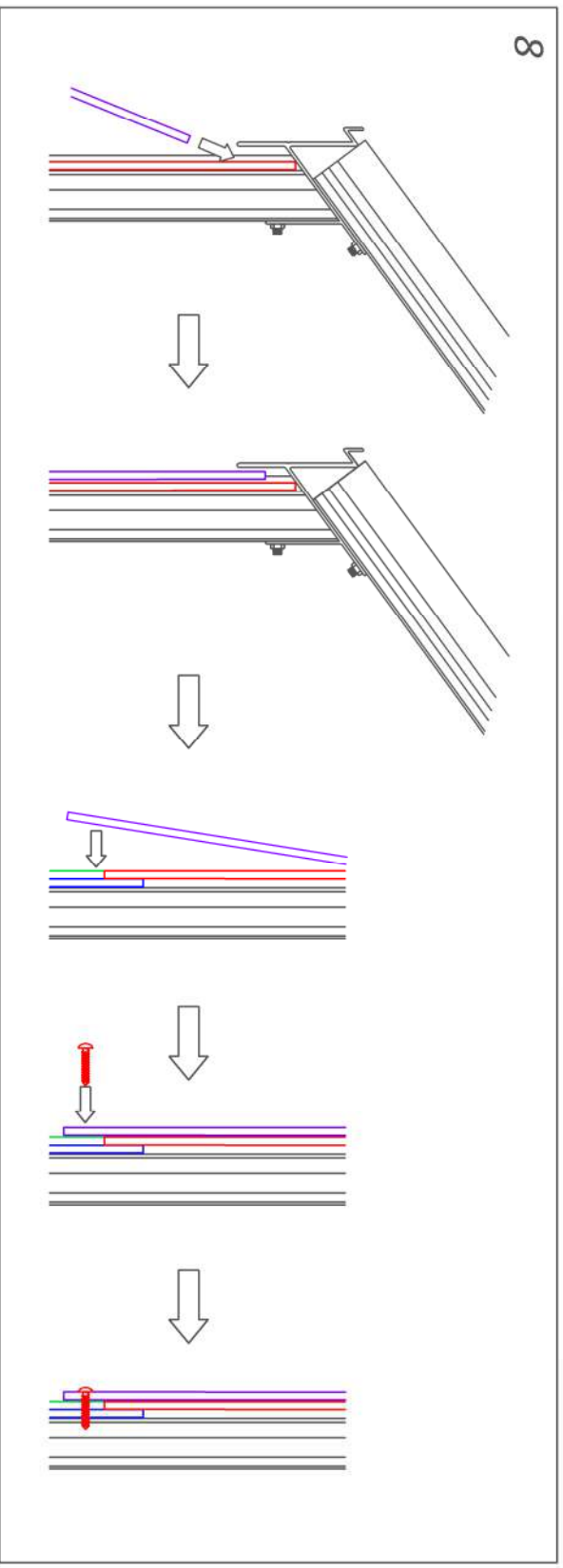
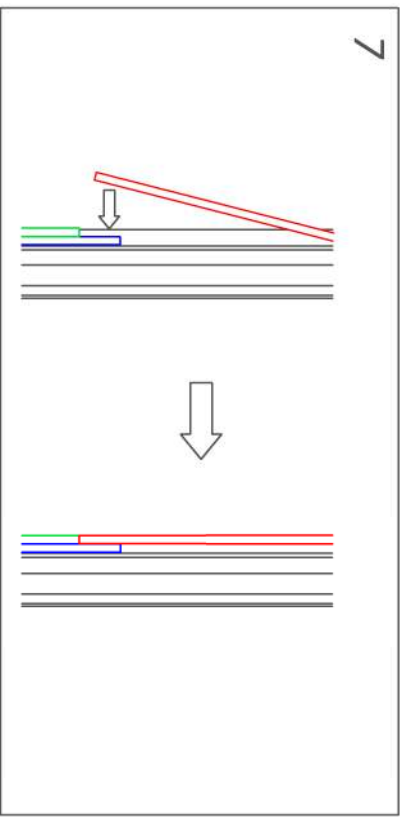
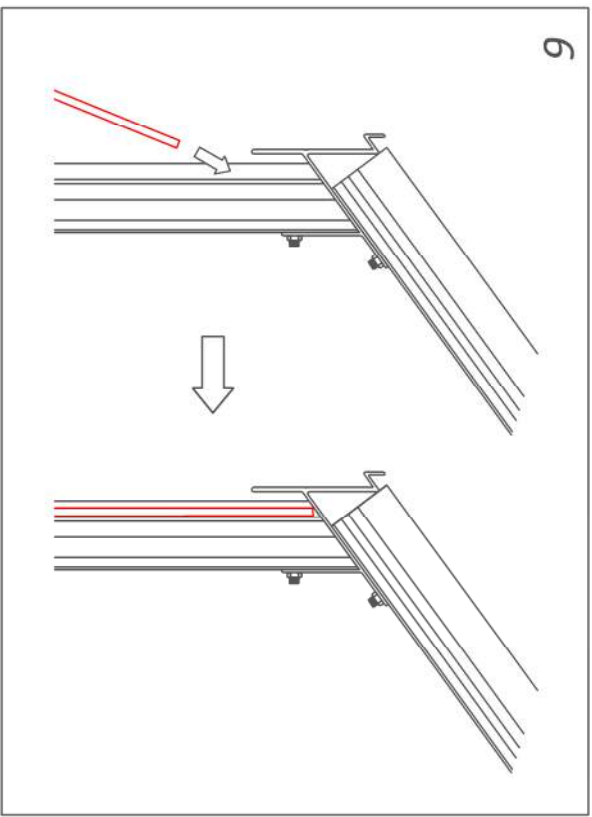

**PRO TIPS**

The only place that the glass won't overlap is the narrow pieces beside a storm door.

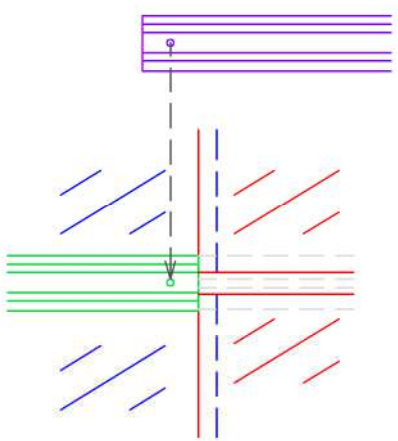

BOTTOM HOLE OF UPPER CAP & TOP HOLE OF LOWER CAP WILL LINE UP & SHARE A SINGLE SCREW.

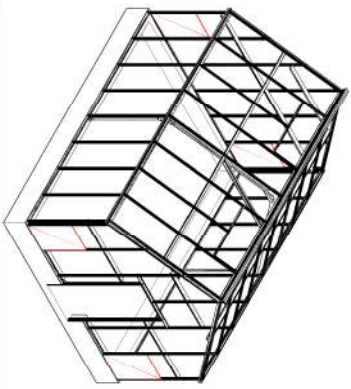

**STAGE 27A: GABLE GLAZING -  
(3MM TEMPERED SINGLE GLASS)**

- STEPS:**
1. PEEL THE BROWN PAPER FROM THE FOAM TAPE ON THE GABLE GLAZING BARS.
  2. INSTALL THE FIRST GLASS PANEL IN ANY GABLE CORNER.
  3. ATTACH THE GLASS CAP TO THE CORNER POST ONLY WITH  $\frac{3}{4}$ " #8 SCREWS.

REPEAT FOR REMAINING GABLE CORNERS

CONTINUE ON NEXT PAGE

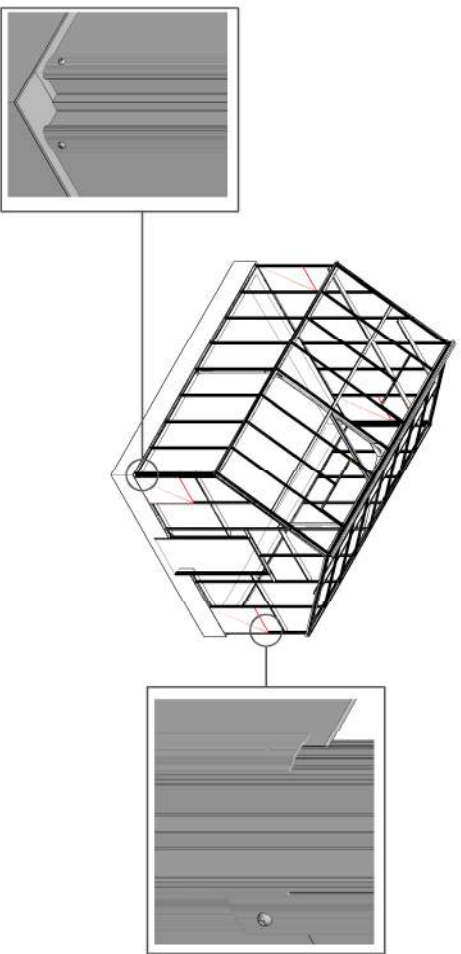

**1**

Peel paper from  
Foam Tape

**2**

Side View

Top View

**3**

**PRO TIPS**

Your Greenhouse will come with a Glass Map showing you the location and dimensions of every piece of glass and the cap.

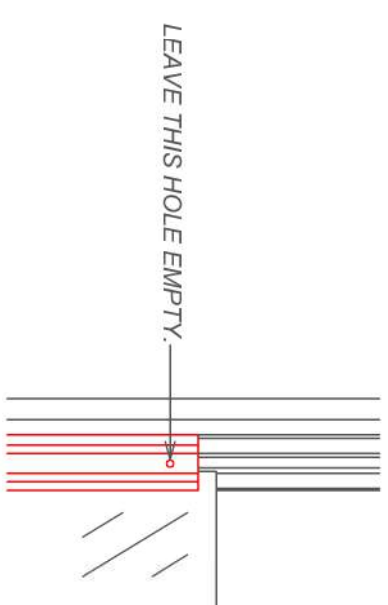

**Parts List:**



Glazing Caps



3mm Tempered Glass Panels



#8 x  $\frac{3}{4}$ " S.S. Screws

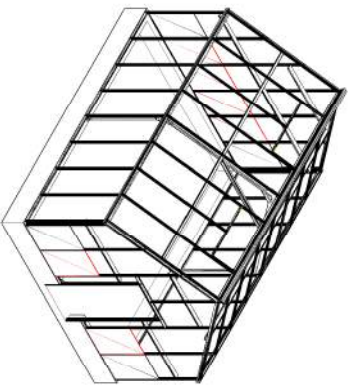

**STAGE 27B: GABLE GLAZING -  
(3MM TEMPERED SINGLE GLASS)**

- STEPS:**
4. INSTALL THE REMAINING GLASS PANELS IN THE BOTTOM ROW OF GABLE GLASS EXCEPT THE NARROW PIECES BESIDE THE STORM DOOR.
  5. ATTACH THE REMAINING GLASS CAPS TO THE BOTTOM ROW OF GLASS AS YOU GO.
- REPEAT FOR ENTIRE BOTTOM ROW OF GABLE GLASS  
CONTINUE ON NEXT PAGE

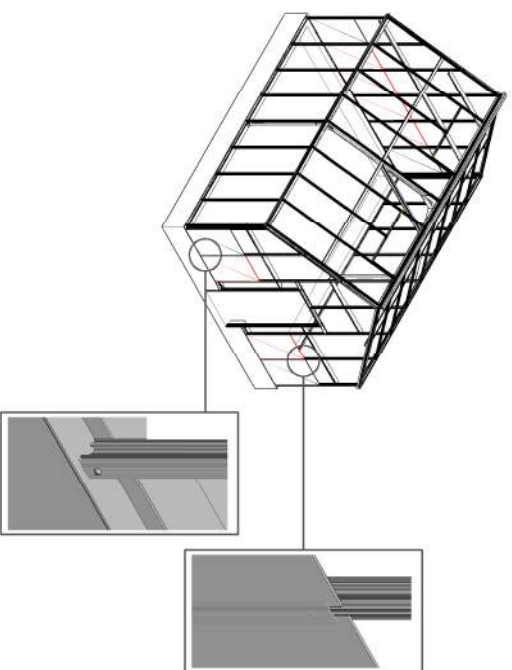

**Parts List:**



Glazing Caps



3mm Tempered Glass Panels



#8 x 3/4" S.S. Screws

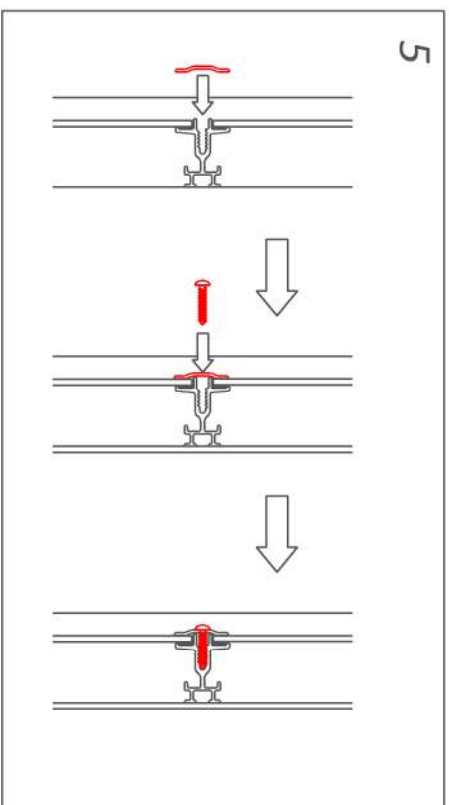
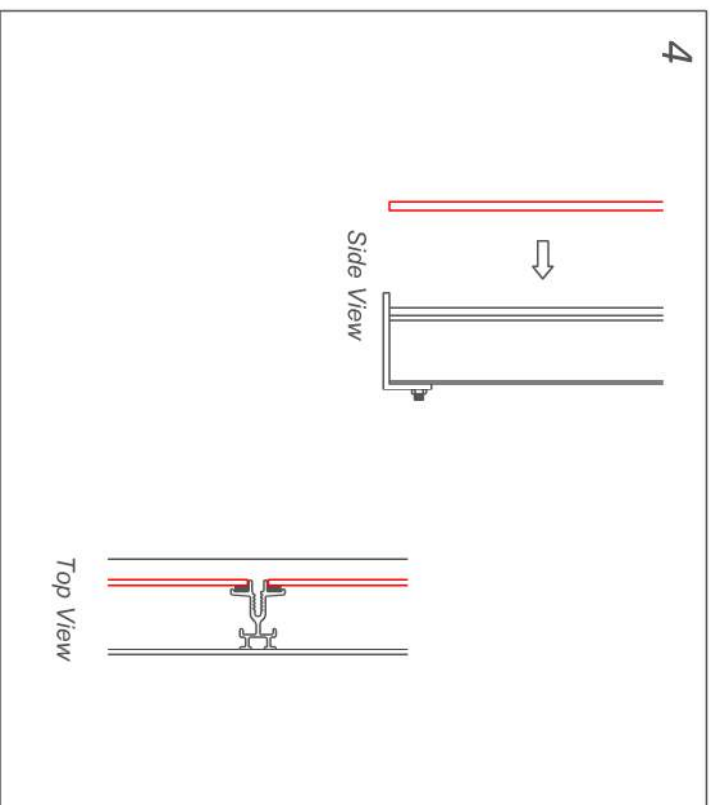

**PRO TIPS**

Do not over-tighten the screws. You want to make the screw snug plus a quarter turn.

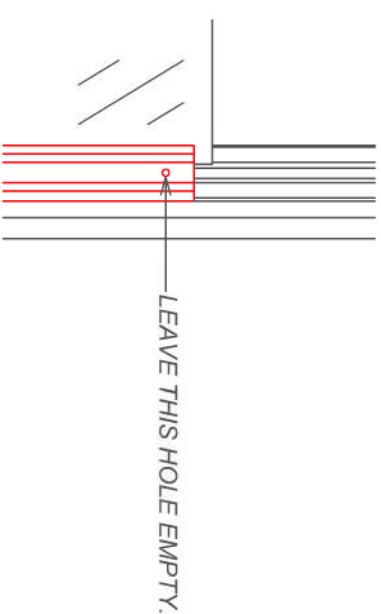

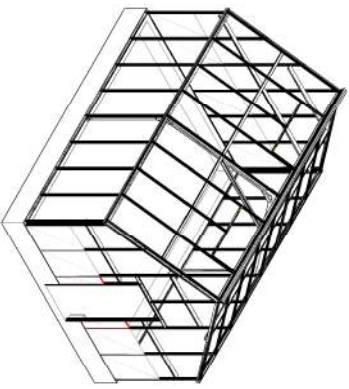

### STAGE 27C: GABLE GLAZING (BESIDE DOOR) (3MM TEMPERED SINGLE GLASS)

- STEPS:**
6. FILL THE GAP BETWEEN THE BASE AND DOOR FRAME WITH CAULKING.
  7. PLACE A PLASTIC H-CAM ON THE TOP OF THE FIRST PIECE OF GLASS BESIDE THE DOOR.
  8. INSERT THE GLASS PANEL INTO THE SIDE OF THE DOOR FRAME AND PRESS TIGHT AGAINST THE FOAM TAPE.
  9. SECURE GLASS PANEL WITH CAP AND  $\frac{3}{4}$ " #8 SCREWS

REPEAT FOR REMAINING GLASS PANELS BESIDE STORM DOOR

CONTINUE ON NEXT PAGE

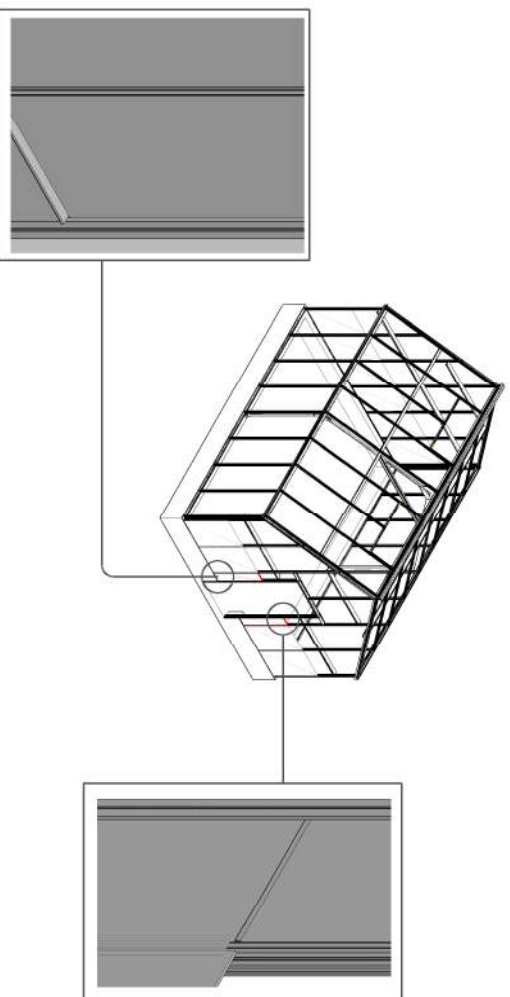

**Parts List:**



Glazing Caps



3mm Tempered Glass Panels



#8 x  $\frac{3}{4}$ " S.S. Screws



h-cam

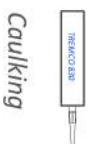

Caulking

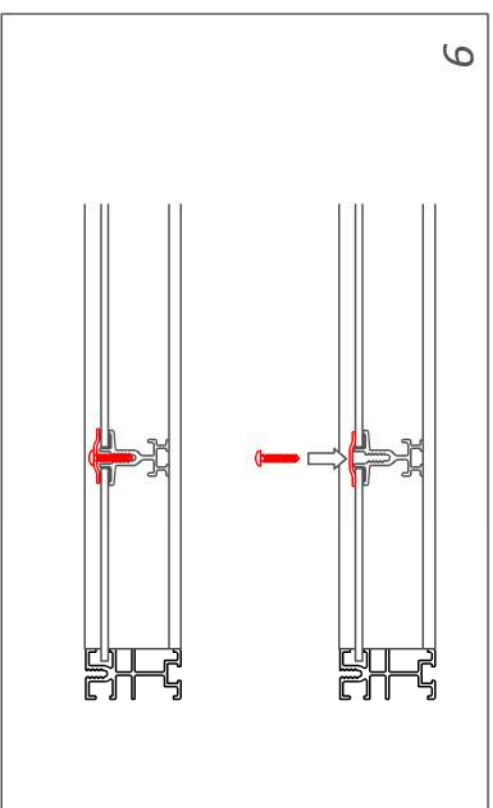
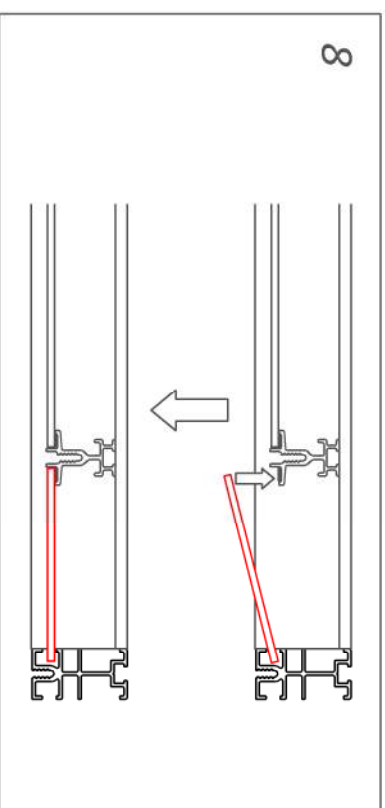
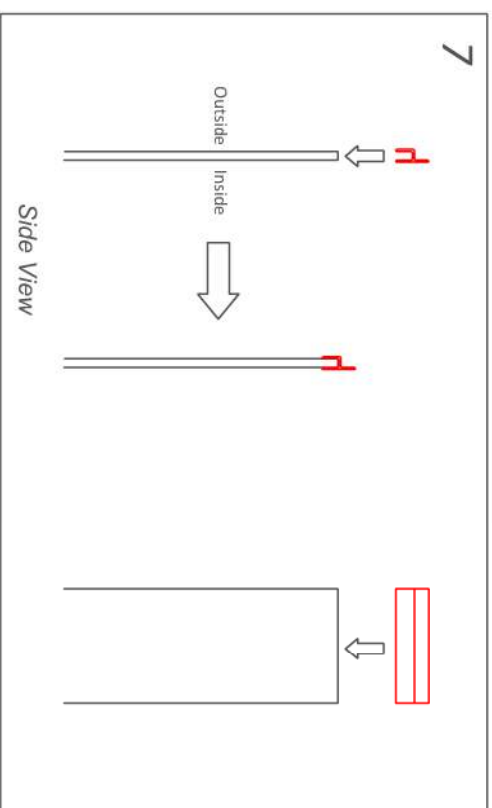
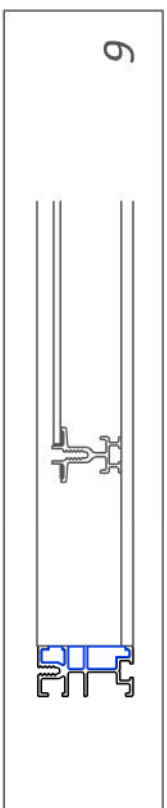

**PRO TIPS**

Do not over-tighten the screws. You want to make the screw snug plus a quarter turn.

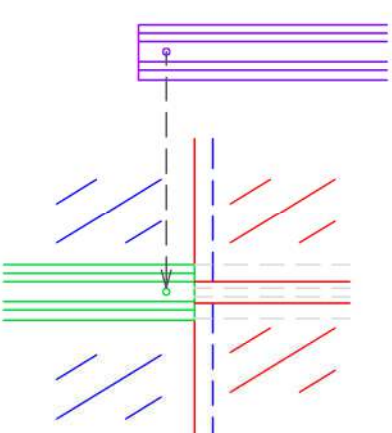

BOTTOM HOLE OF UPPER CAP & TOP HOLE OF LOWER CAP WILL LINE UP & SHARE A SINGLE SCREW.

PRO TIPS



Do not over-tighten the screws. You want to make the screw snug plus a quarter turn.

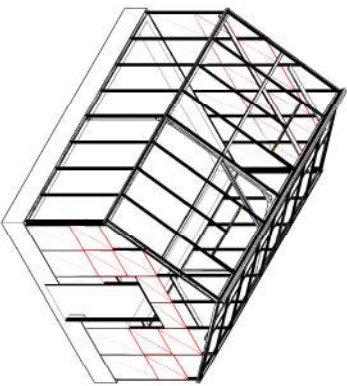

STAGE 27D: GABLE GLAZING - (3MM TEMPERED SINGLE GLASS)

STEPS:

- 10. STARTING AT ONE CORNER, REST THE GLASS PANELS ON TOP OF THE CAPS BELOW AND PRESS TIGHT AGAINST THE GLAZING FOAM
  - 11. SECURE THE CAP WITH 3/8" #8 SCREWS LEAVING THE TOP HOLE ON THE CAP EMPTY
- REPEAT FOR REMAINING SQUARE CUT GABLE GLASS
- CONTINUE ON NEXT PAGE

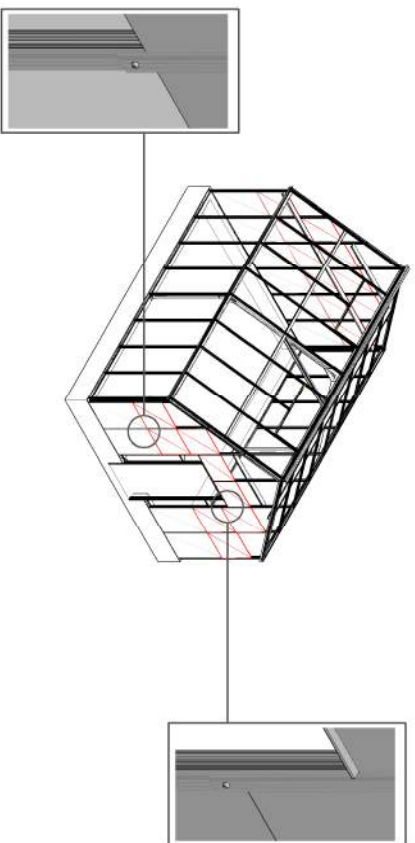
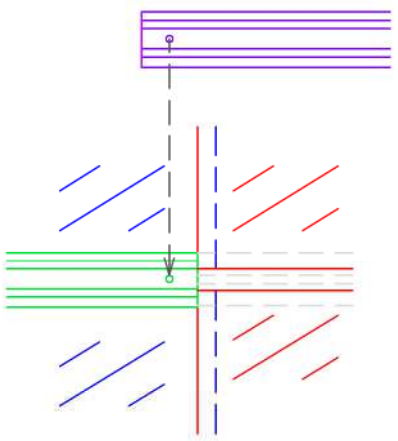
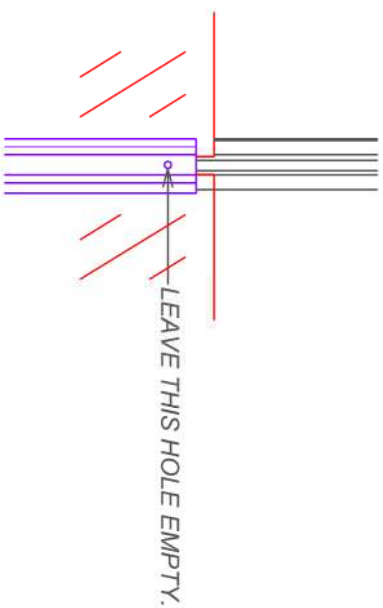
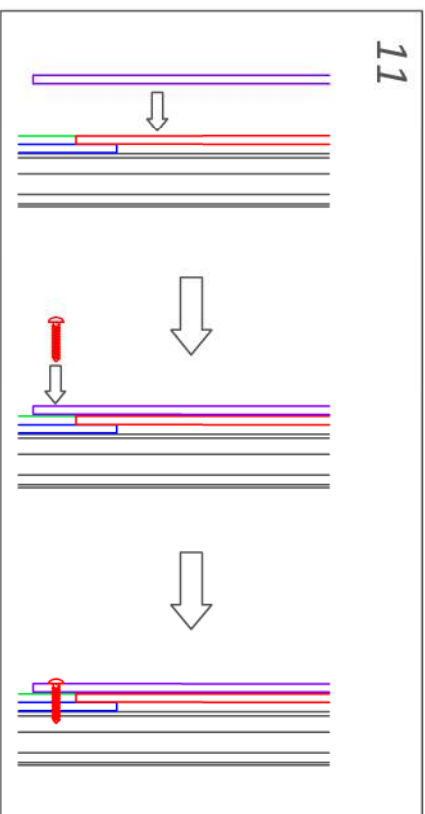
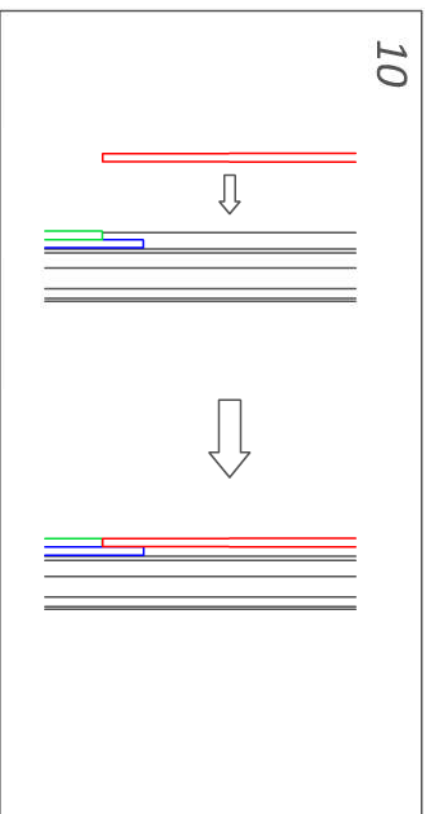

Parts List:



Glazing Caps



3mm Tempered Glass Panels



#8 x 3/8" S.S. Screws

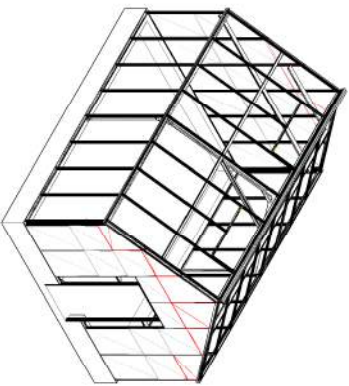

**STAGE 27E: GABLE GLAZING -  
(3MM TEMPERED SINGLE GLASS)**

- STEPS:**
- 12. STARTING AT ONE CORNER, SLIP THE ANGLE CUT GLASS PANEL BENEATH THE END RAFTER.
  - 13. REST THE GLASS PANELS ON TOP OF THE CAPS BELOW AND PRESS TIGHT AGAINST THE GLAZING FOAM
  - 14. SLIP THE TOP OF THE CAP BENEATH THE END RAFTER & SECURE THE CAP WITH  $\frac{3}{4}$ " #8 SCREWS.
- REPEAT FOR REMAINING ANGLE CUT GABLE GLASS

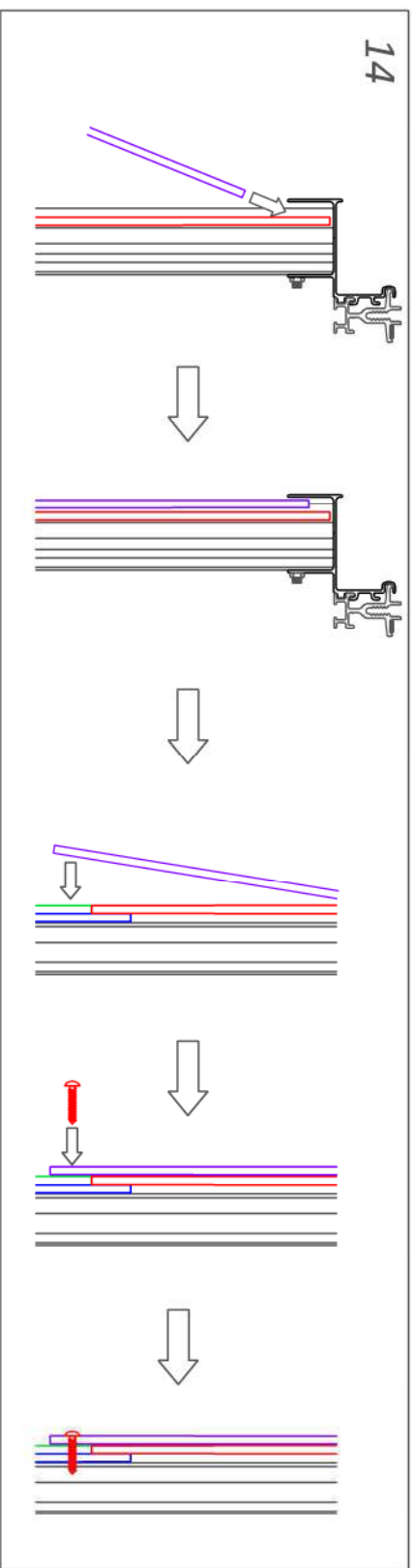
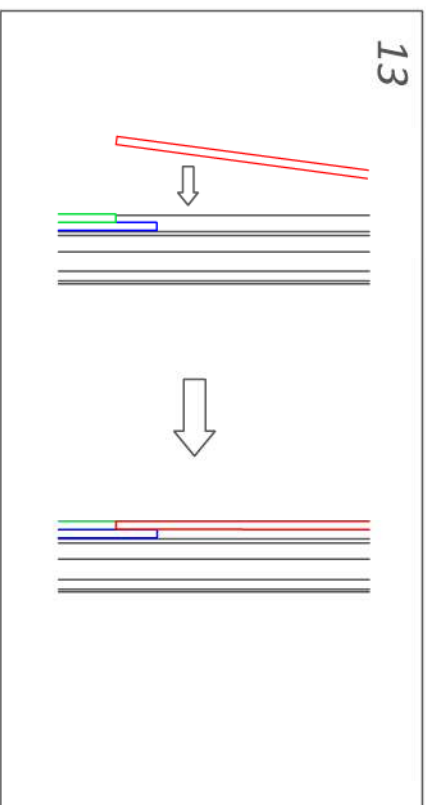
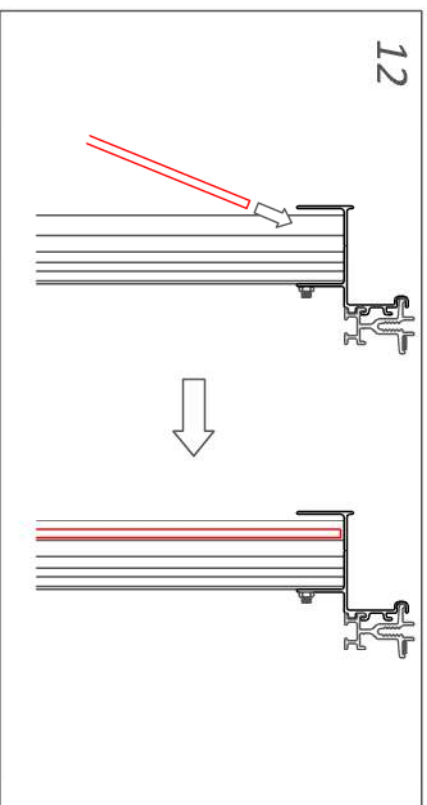
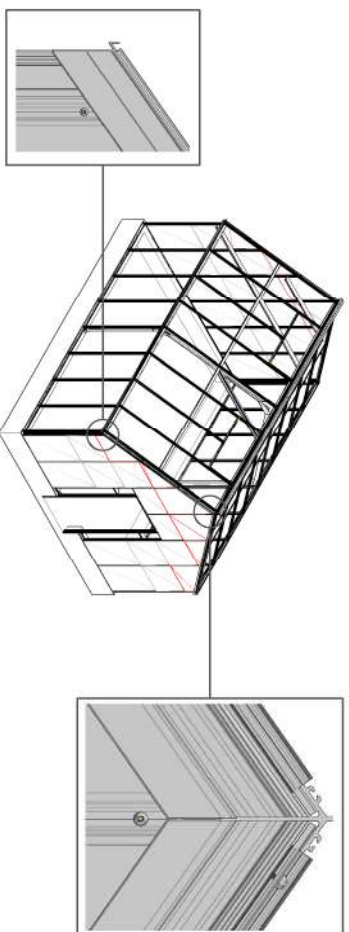

**PRO TIPS**

Short Caps may be buckled or crimped on one end to make it easier for them to fit beneath the End Rafter

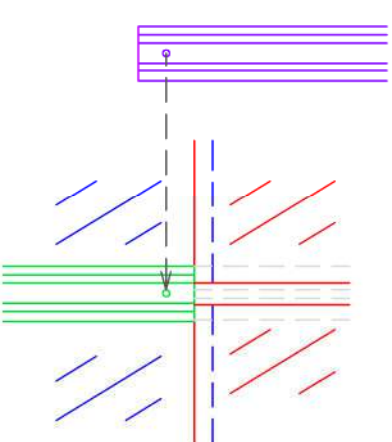

BOTTOM HOLE OF UPPER CAP & TOP HOLE OF LOWER CAP WILL LINE UP & SHARE A SINGLE SCREW.

**Parts List:**



Glazing Caps



3mm Tempered Glass Panels



#8 x  $\frac{3}{4}$ " S.S. Screws



# STAGE 28: SEALING - (3mm SINGLE GLASS)

- CLEAR SILICONE (PROGLAZE)
- COLORED CAULKING (TREMCO 830)

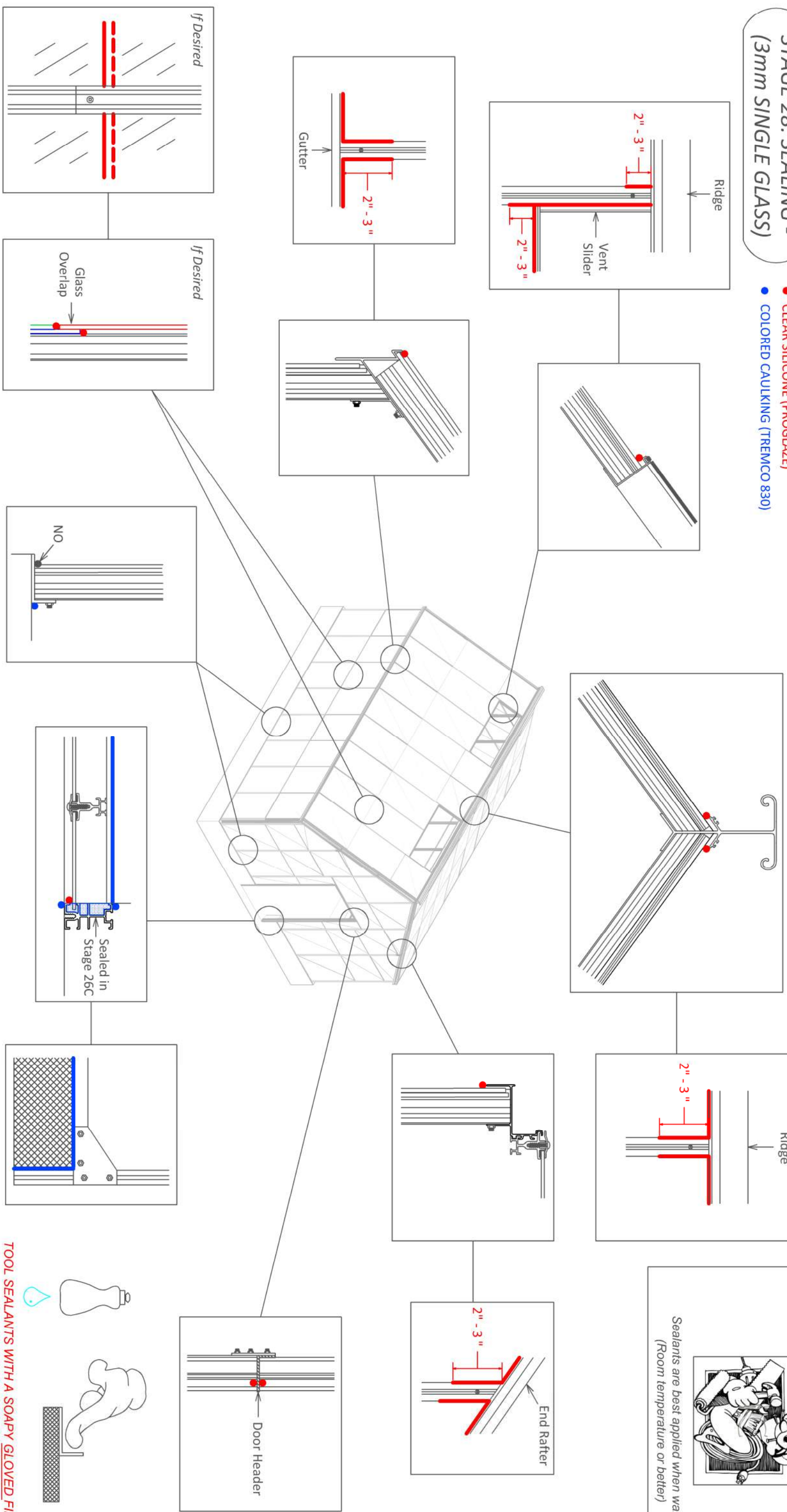

## Parts List:

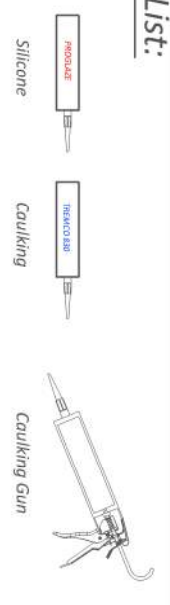

TOOL SEALANTS WITH A SOAPY GLOVED FINGER  
OR A CAULK-SMOOTHING TOOL.

**PRO TIPS**  
Sealants are best applied when warm  
(Room temperature or better)

**PRO TIPS**



Have one person working outside the greenhouse and one on the inside to help fit the glass panels into the Ridge.

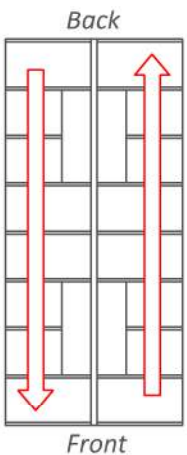
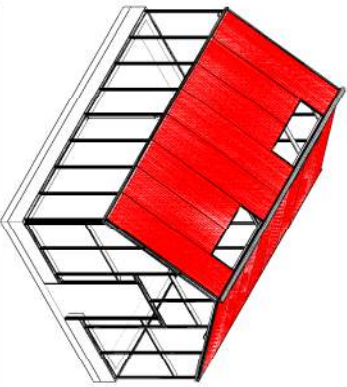

GLAZE & CAP THE ROOF IN ORDER FROM BACK TO FRONT AND THEN FRONT TO BACK. COMPLETE ONE SIDE BEFORE BEGINNING THE NEXT.

**STAGE 29A: ROOF GLAZING - (16MM DOUBLE GLASS)**

- STEPS:**
1. PEELE THE BROWN PAPER FROM THE FOAM TAPE ON THE ROOF GLAZING BARS .
  2. PLACE THE H-CHANNEL ONTO THE BOTTOM OF A GLASS PANEL
- CONTINUE ON NEXT PAGE

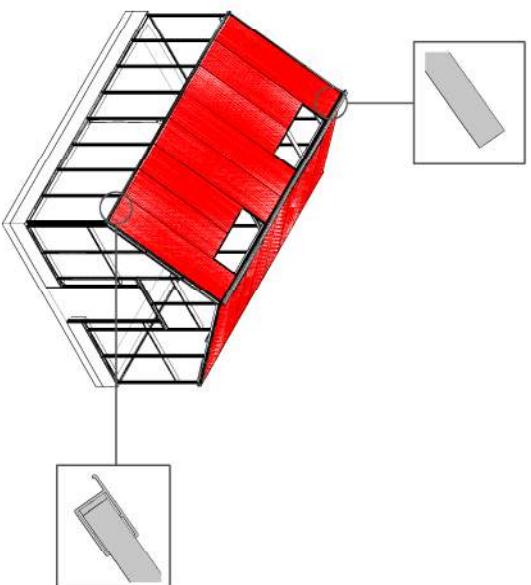

1

Peel paper from Foam Tape







2

**\*WARNINGS\***  
 If your glass has a Low-E Protective Coating, the sticker on the glass will go on the inside.

If your Greenhouse is being installed at an elevation above 2000', your glass may have Breather Tubes installed. There will be instructional stickers attached to the glass. Breather Tubes must be pinched and sealed prior to installation. On hot days, you may find that the Glazing Foam is too sticky. Spraying the foam with a light soapy water will make installing the Glass easier.

Glazing Caps & h-Channels will come packaged specific to their location in the greenhouse. Open the Bundles only as you need them.

**Parts List:**

-  Glazing Caps
-  Glazing Caps (Ripped)
-  h-Channels (Top)
-  h-Channels (Bottom)
-  16mm Double Glass Panels
-  Setting Blocks
- #8 x 3/4 S.S. Screws icon" data-bbox="60 790 80 805"/> #8 x 3/4" S.S. Screws



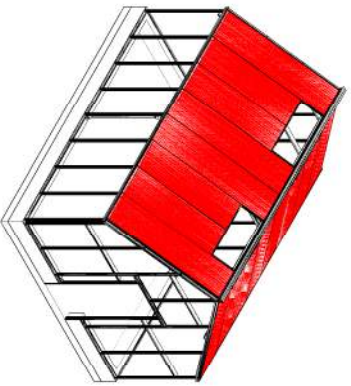

STAGE 29B: ROOF GLAZING -  
(16MM DOUBLE GLASS)

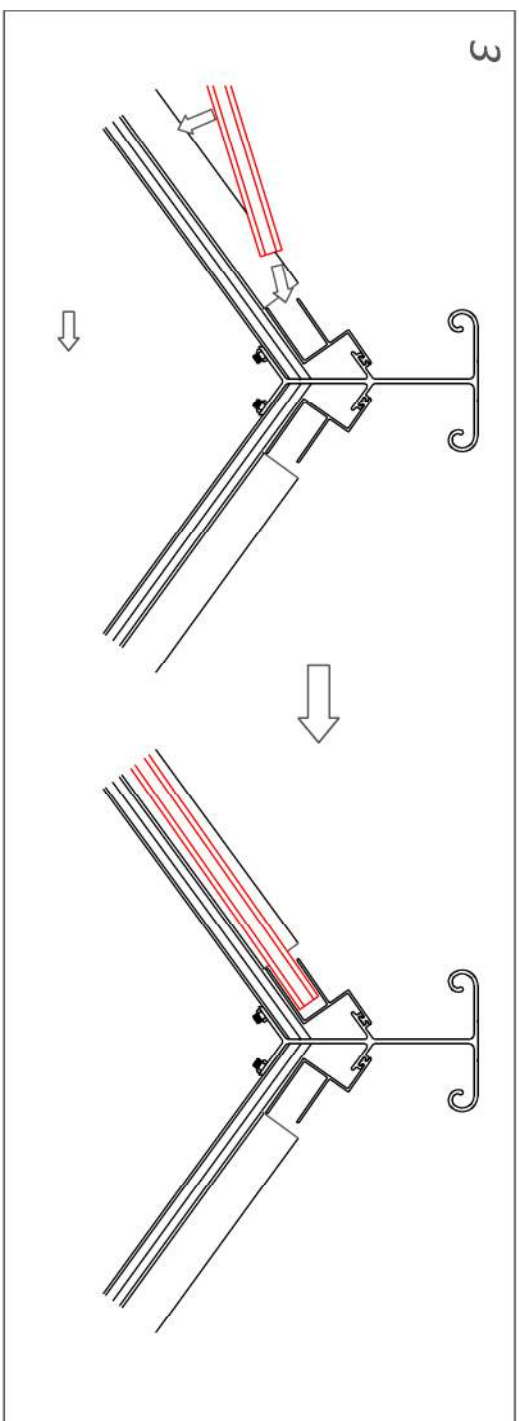

STEPS:





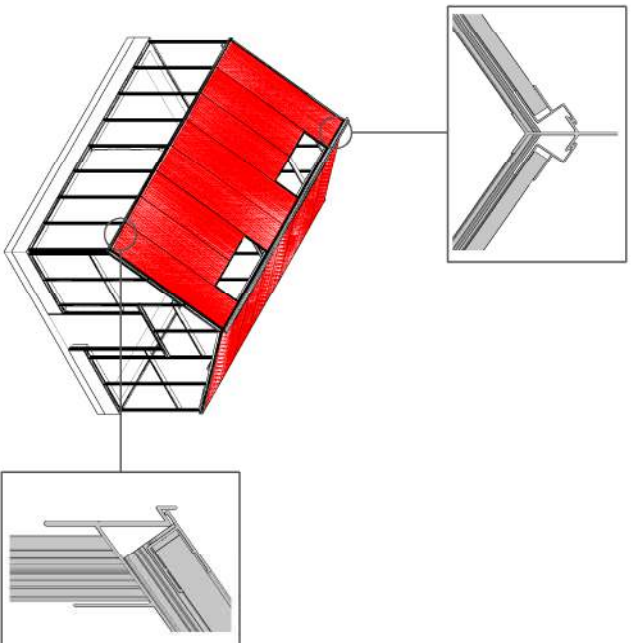
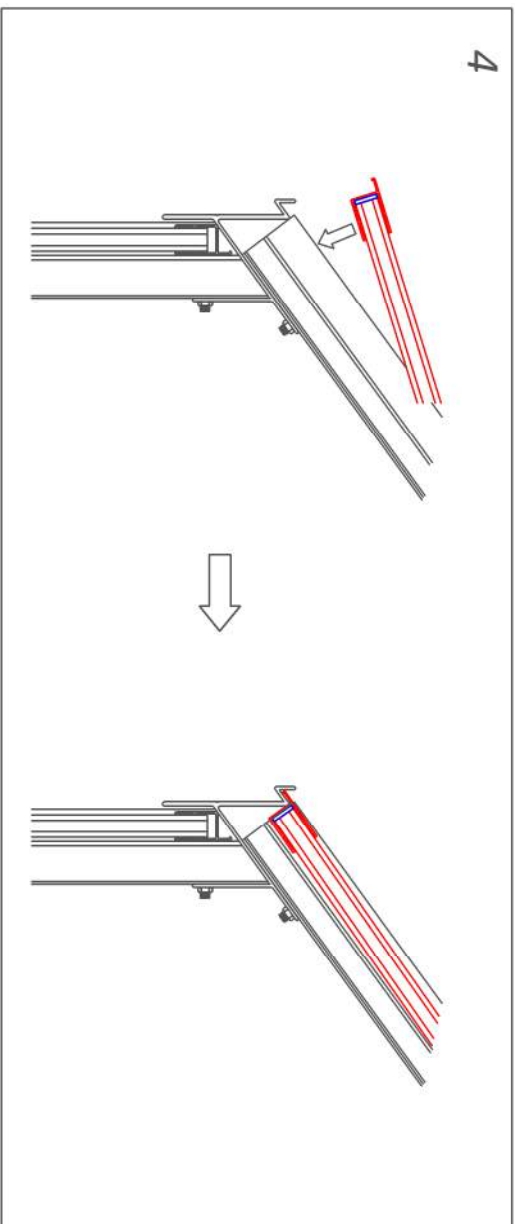

3. INSERT THE TOP OF THE GLASS PANEL INTO THE RIDGE.  
4. INSERT THE H-CHANNEL AT THE BOTTOM OF THE PANEL INTO THE GUTTER.

REPEAT

CONTINUE ON NEXT PAGE



Parts List:

-  Glazing Caps
-  Glazing Caps (Ripped)
-  h-Channels (Top)
-  h-Channels (Bottom)
-  16mm Double Glass Panels
-  Setting Blocks
- #8 x 3/4" S.S. Screws icon" data-bbox="60 790 80 805"/> #8 x 3/4" S.S. Screws

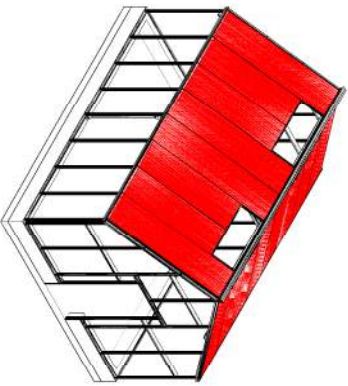

**STAGE 29C: ROOF GLAZING -  
(16MM DOUBLE GLASS)**





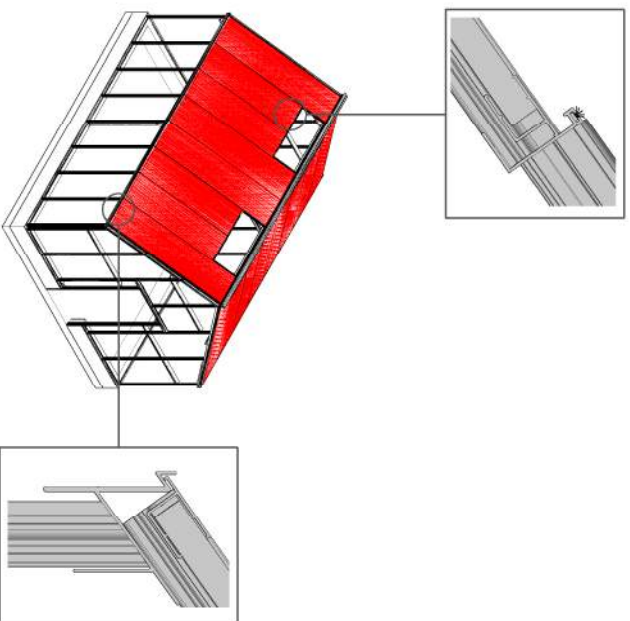
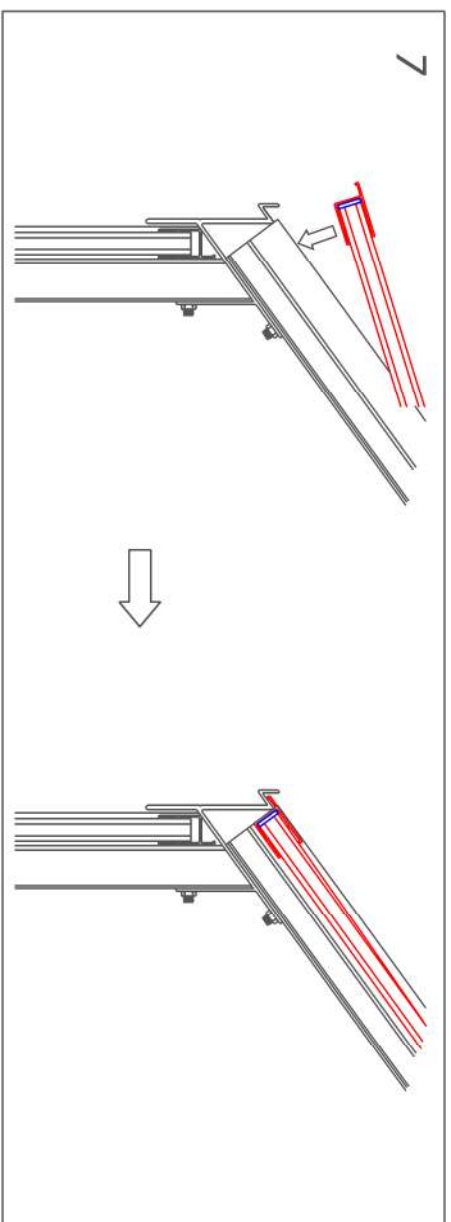
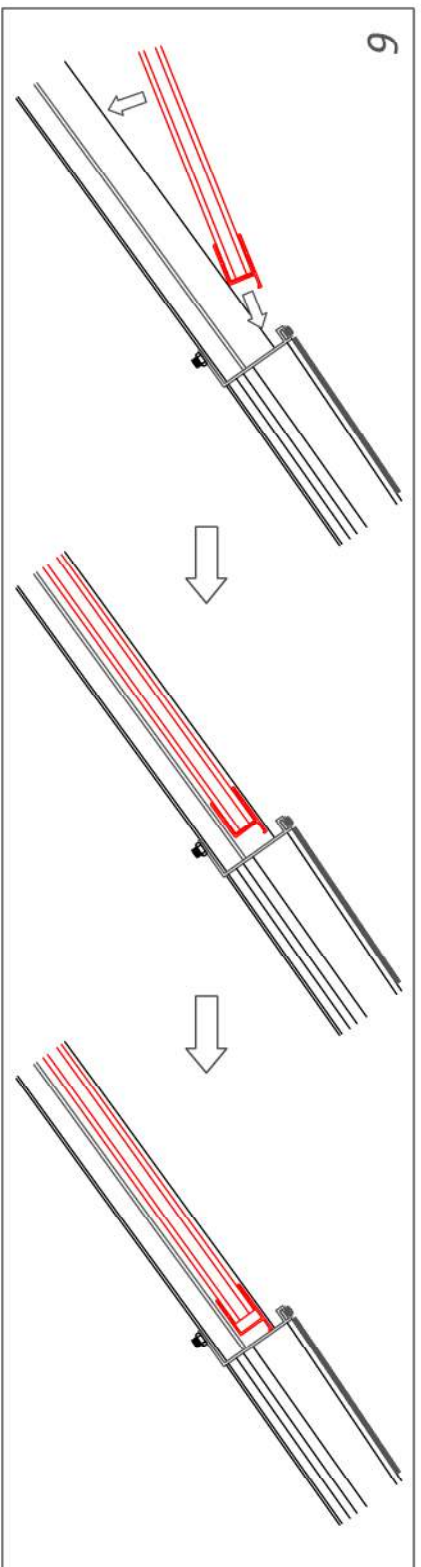
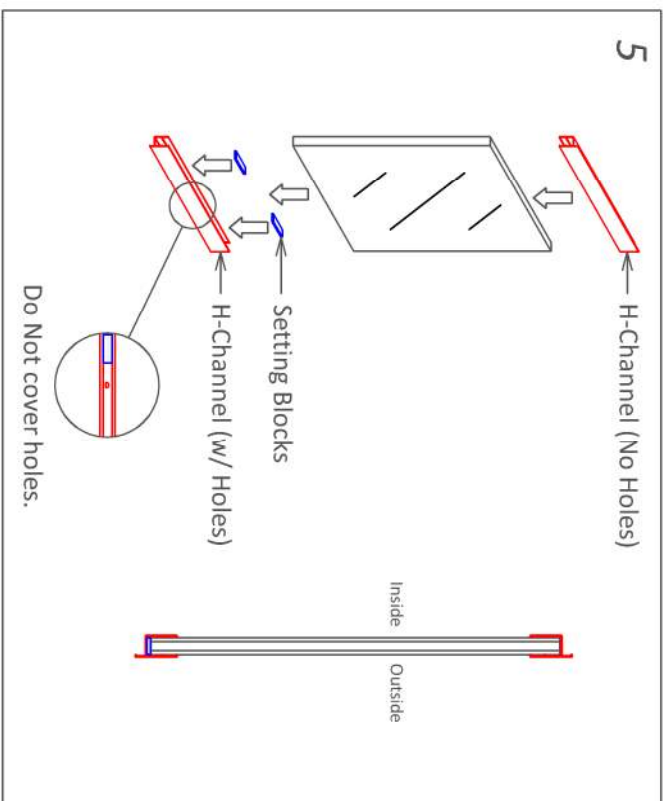

- STEPS:**
5. APPLY H-CHANNELS & SETTING BLOCKS TO TOP AND BOTTOM OF GLASS PANELS.
  6. INSTALL THE GLASS PANEL BELOW THE VENT FRAME BOTTOM & SLIDE THE H-CHANNEL UP UNTIL IT TOUCHES THE VENT FRAME BOTTOM.
  7. INSERT THE H-CHANNEL AT THE BOTTOM OF THE PANEL INTO THE GUTTER.

REPEAT

CONTINUE ON NEXT PAGE



**Parts List:**

-  Glazing Caps
-  Glazing Caps (Ripped)
-  h-Channels (Top)
-  h-Channels (Bottom)
-  16mm Double Glass Panels
-  Setting Blocks
- #8 x 3/4" S.S. Screws icon" data-bbox="60 790 80 805"/> #8 x 3/4" S.S. Screws

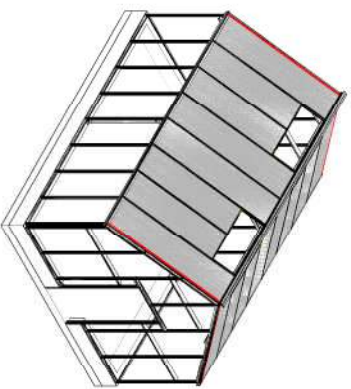





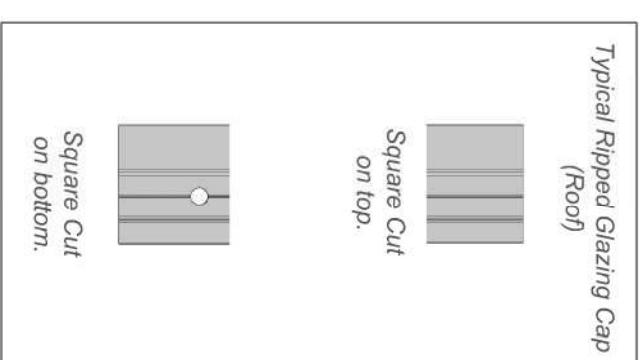
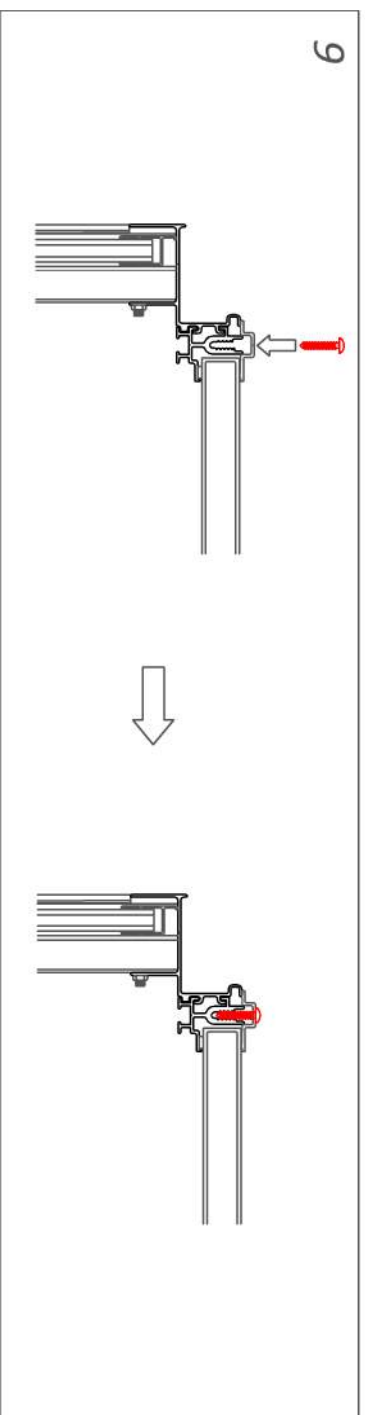
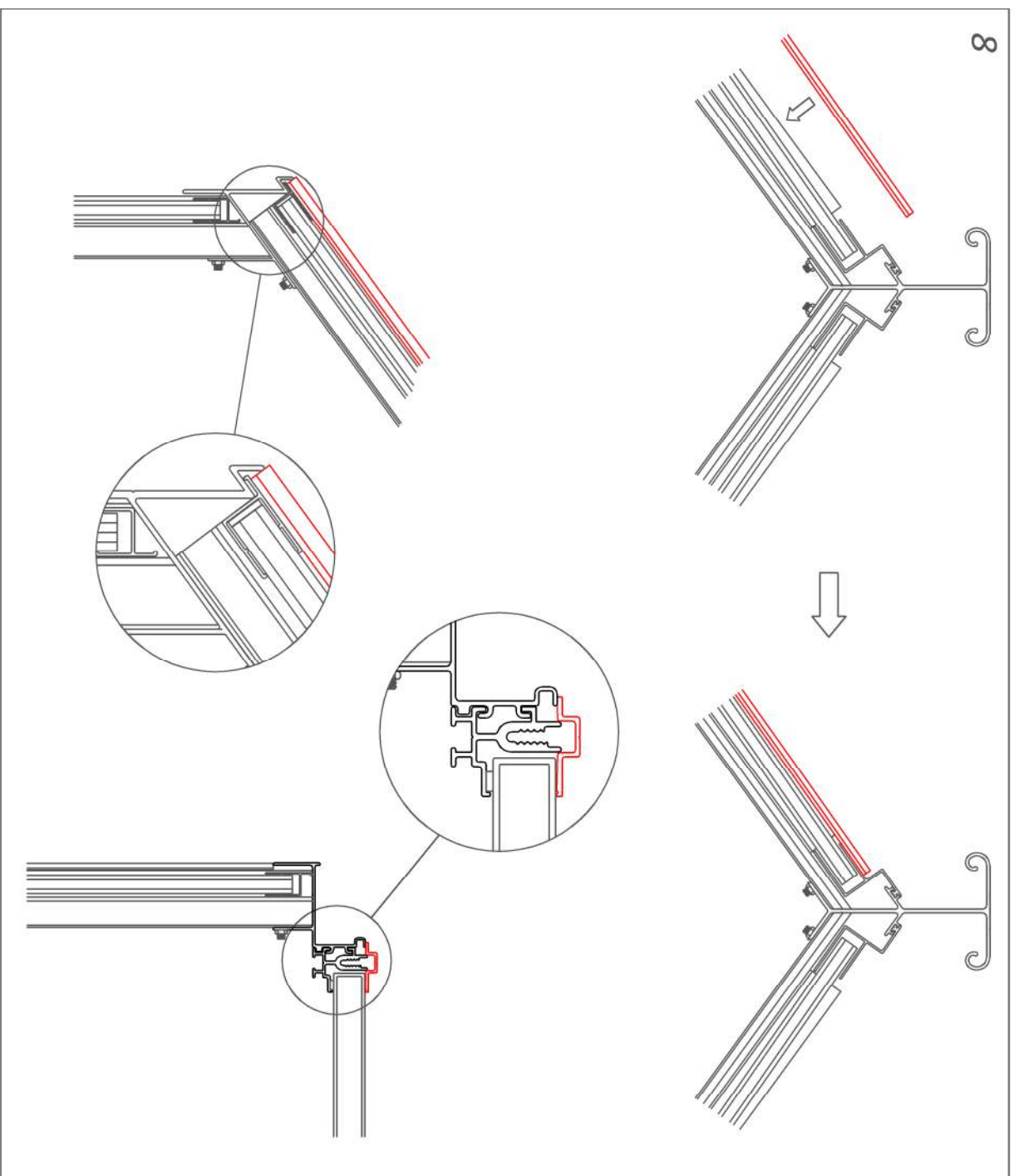
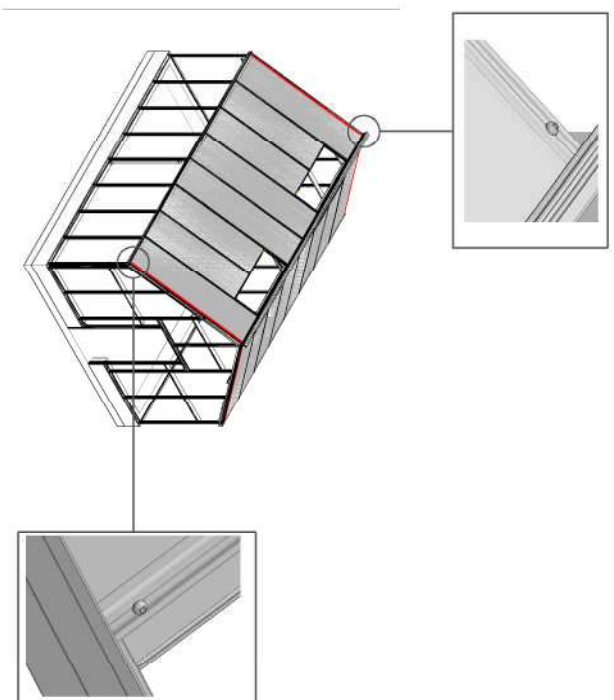

**STAGE 29D: ROOF END CAPS-  
(16MM DOUBLE GLASS)**

- STEPS:**
8. LAY THE RIPPED CAP ON THE END RAFTER & GLAZING BAR  
(CAP SHOULD SIT TIGHT TO THE GUTTER)
  9. SECURE THE CAP TO THE GLAZING BAR.
- REPEAT FOR ALL CORNERS  
CONTINUE ON NEXT PAGE



**Parts List:**

-  Glazing Caps
-  Glazing Caps (Ripped)
-  h-Channels (Top)
-  h-Channels (Bottom)
-  16mm Double Glass Panels
-  Setting Blocks
-  #8 x  $\frac{3}{4}$ " S.S. Screws

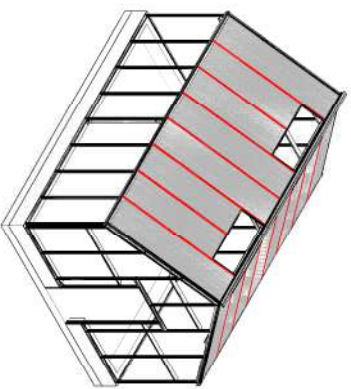





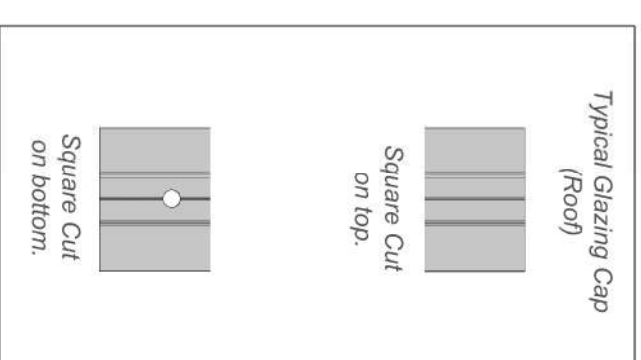
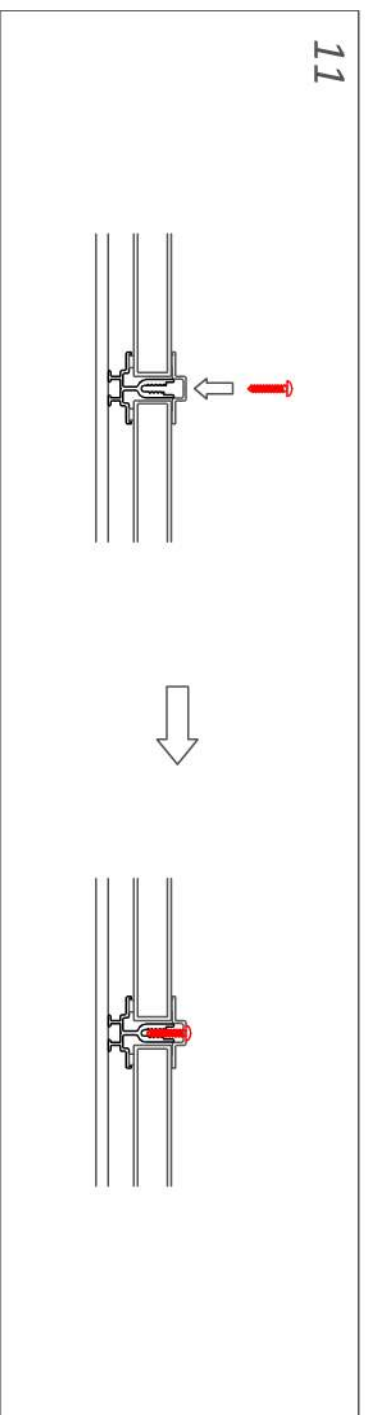
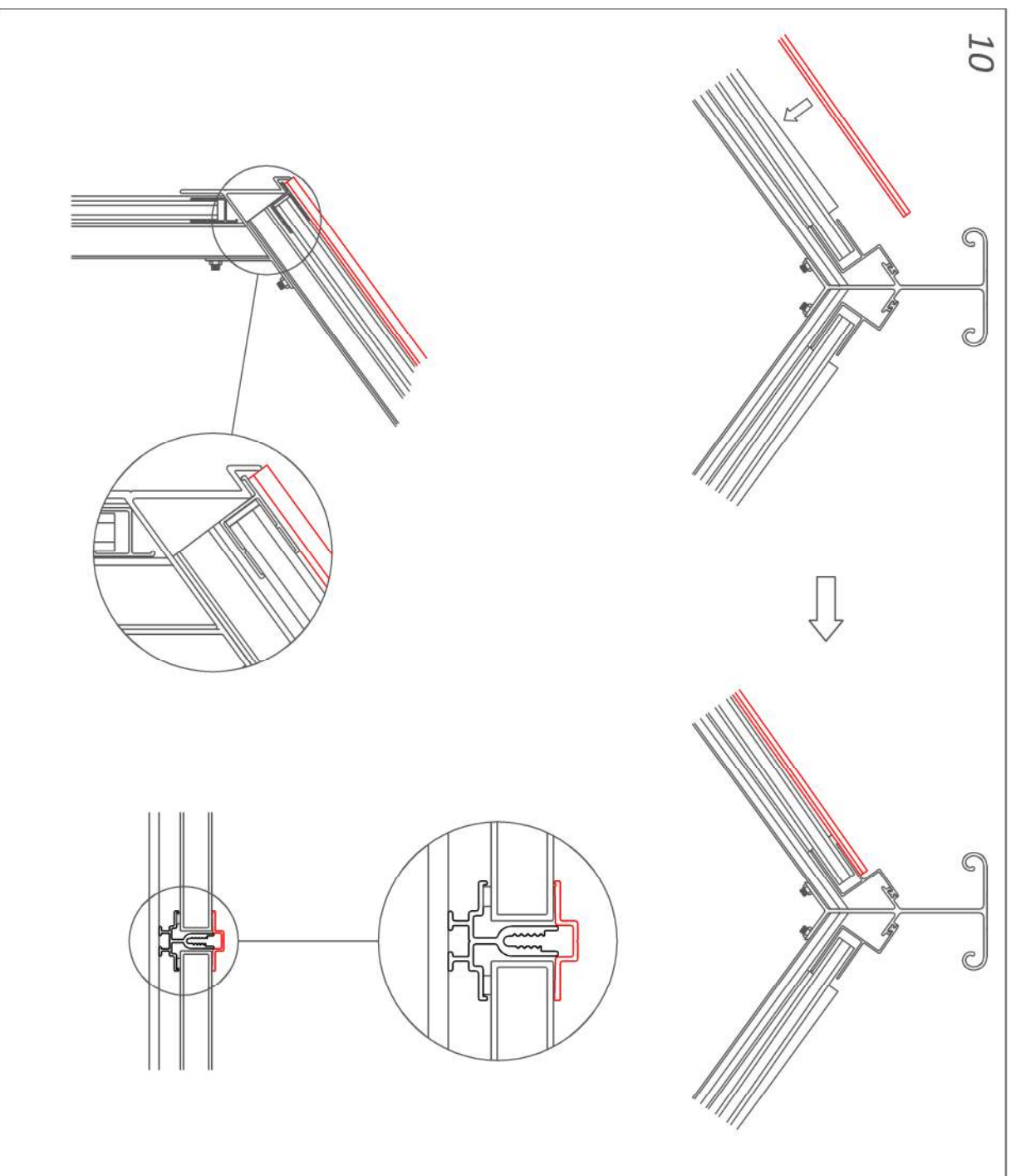
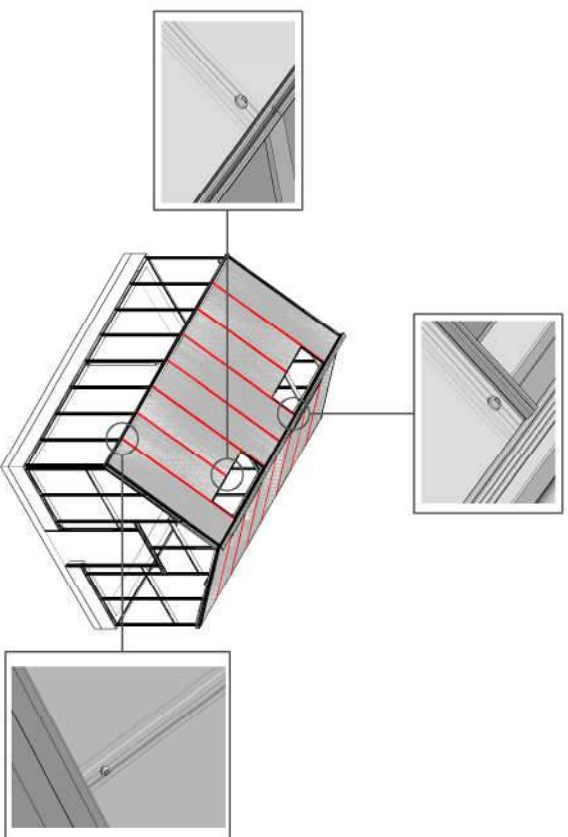

**STAGE 29E: ROOF CAPS -  
(16MM DOUBLE GLASS)**

- STEPS:**  
 10. LAY THE CAP ON THE GLAZING BAR (CAP SHOULD SIT TIGHT TO THE GUTTER)  
 11 SECURE THE CAP TO THE GLAZING BAR.  
 REPEAT FOR ALL REMAINING CAPS



**Parts List:**

-  Glazing Caps
-  Glazing Caps (Ripped)
-  h-Channels (Top)
-  h-Channels (Bottom)
-  16mm Double Glass Panels
-  Setting Blocks
-  #8 x 3/4" S.S. Screws

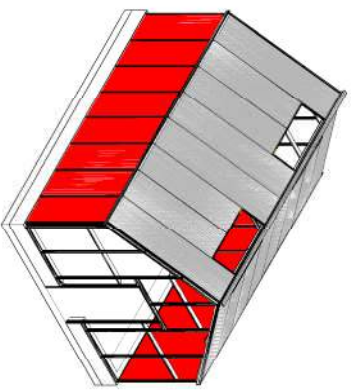

**STAGE 30A: SIDE WALL GLAZING -  
(16MM DOUBLE GLASS)**

- STEPS:**
1. PEEB THE BROWN PAPER FROM THE FOAM TAPE ON THE SIDE WALL GLAZING BARS .
  2. PLACE THE H-CHANNELS & SETTING BLOCKS ONTO THE TOP & BOTTOM OF A GLASS PANEL
- CONTINUE ON NEXT PAGE

**\*WARNINGS\***  
**- DO NOT USE A CORDLESS DRILL DURING THIS STAGE-  
 OVER-TIGHTENING THE SCREWS CAN  
 CAUSE THE GLASS TO SHATTER**

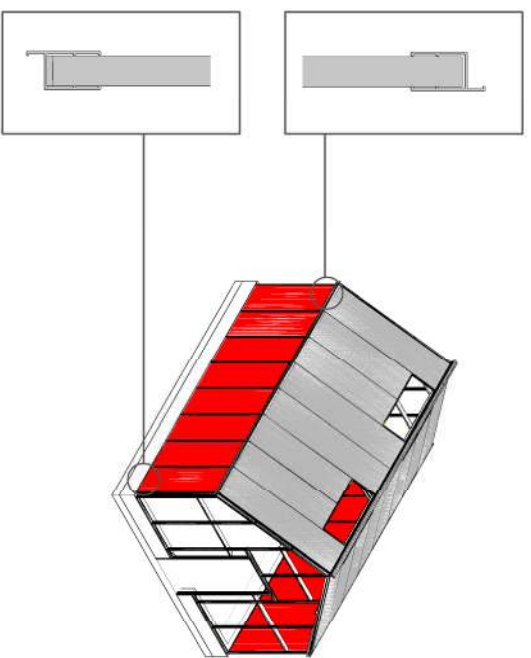

**1**

Peel paper from  
Foam Tape



**2**

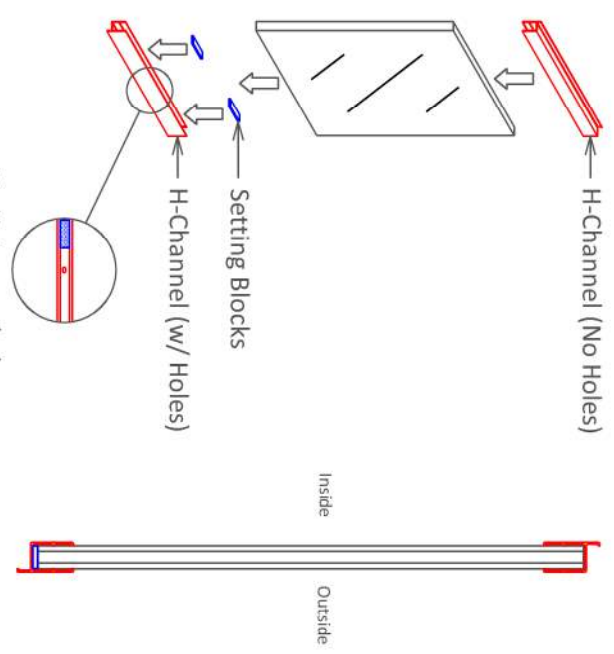

H-Channel (No Holes)

H-Channel (w/ Holes)

Setting Blocks

Do Not cover holes.

Inside

Outside

**PRO TIPS**



Applying a drop of silicone to the  
Setting Blocks before installing will  
prevent them from sliding out of position.

**Parts List:**

- Glazing Caps
- Glazing Caps (Ripped)
- h-Channels (Top)
- h-Channels (Bottom)
- 16mm Tempered Glass Panels
- Setting Blocks
- #8 x 3/4" S.S. Screws

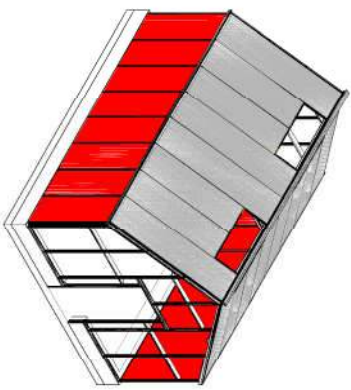

### STAGE 30B: SIDE WALL GLAZING - (16MM DOUBLE GLASS)

**STEPS:**

3. SLIP THE TOP OF THE GLASS PANEL BENEATH THE GUTTER.
4. PUSH THE BOTTOM OF THE GLASS PANEL INTO POSITION.
5. PUSH THE TOP H-CHANNEL UP UNTIL IT TOUCHES THE UNDERSIDE OF THE GUTTER.

REPEAT FOR ALL SIDE WALL GLAZING

CONTINUE ON NEXT PAGE

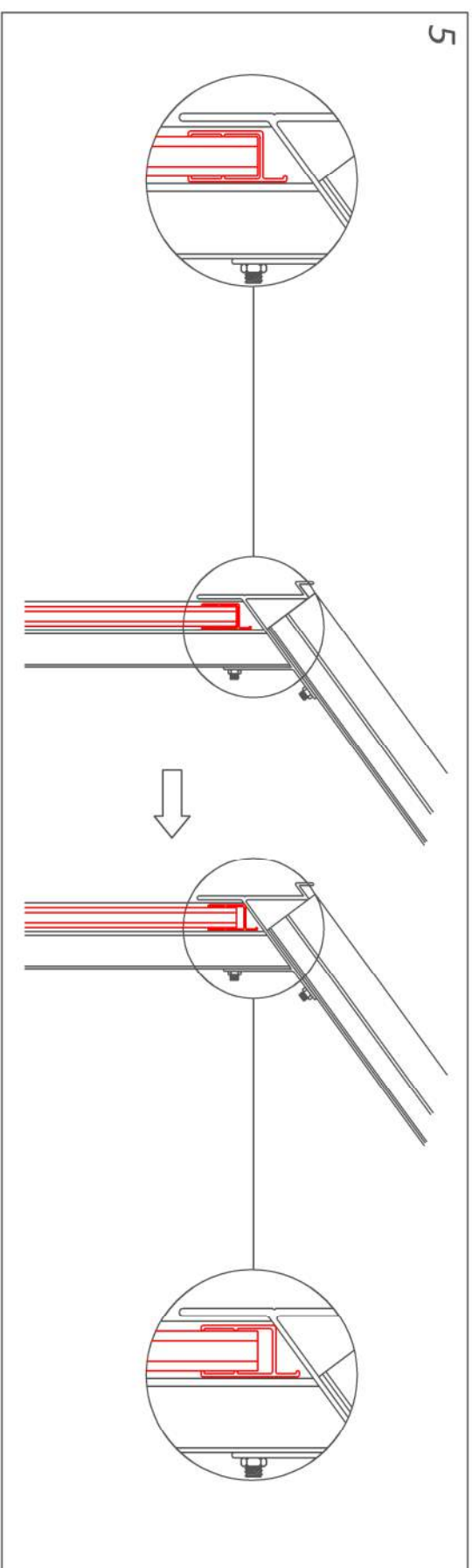
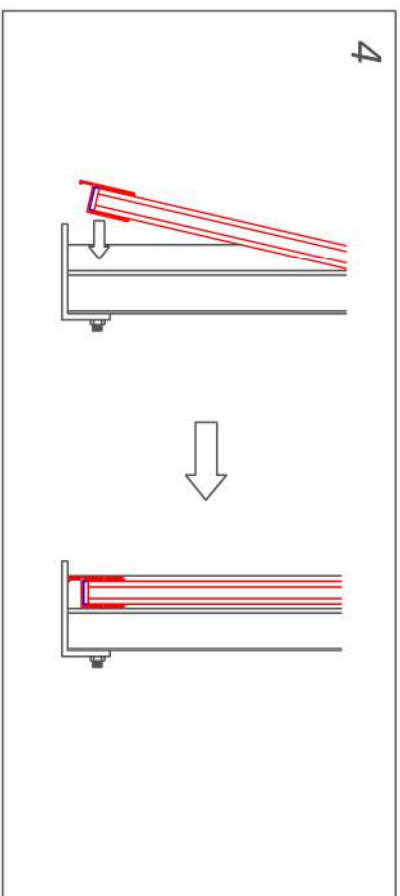
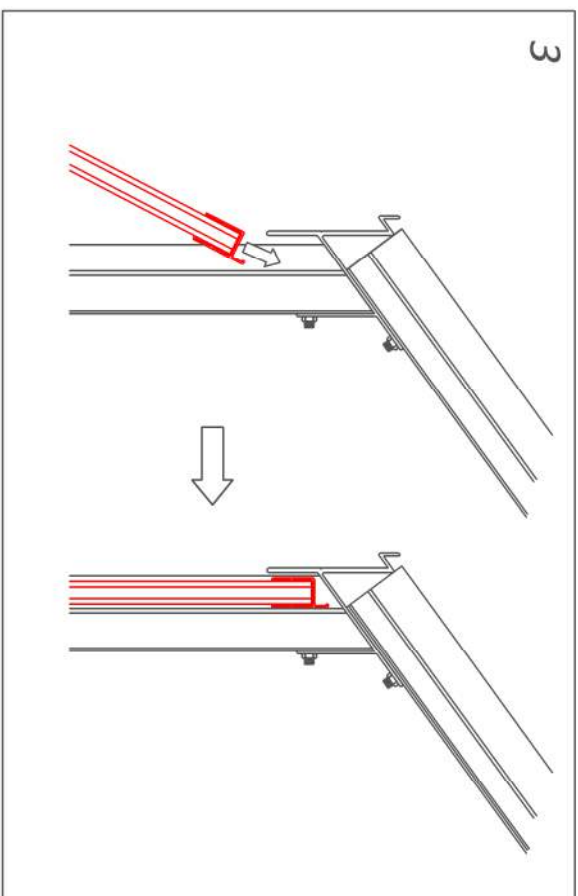
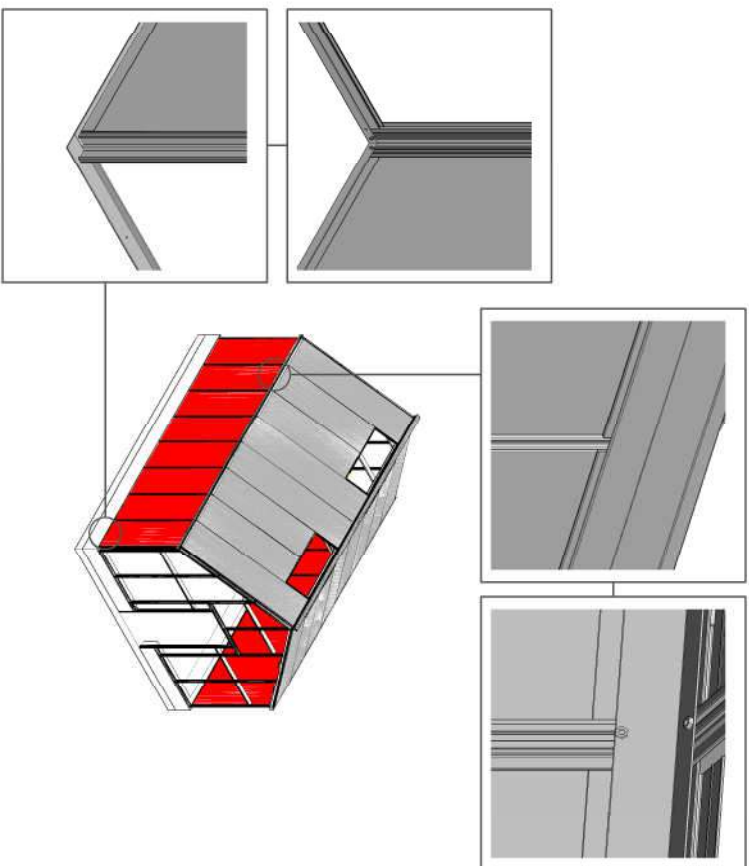







**PRO TIPS**



Start by glazing the 4 corners on the side walls of the greenhouse. This will help to square the frame from front to back. Don't be afraid to shift the Frame as necessary.

**Parts List:**

-  Glazing Caps
-  Glazing Caps (Ripped)
-  h-Channels (Top)
-  h-Channels (Bottom)
-  16mm Tempered Glass Panels
-  Setting Blocks
- #8 x 3/4\" S.S. Screws icon" data-bbox="65 795 85 815"/> #8 x 3/4" S.S. Screws



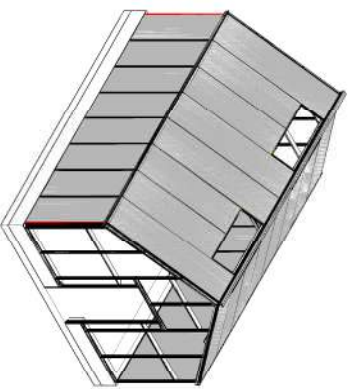

**STAGE 30C: SIDE WALL CORNER CAPS -  
(16MM DOUBLE GLASS)**

**STEPS:**

6. PRESS THE RIPPED CAP AGAINST THE GLAZING BAR & CORNER POST.
7. SECURE THE CAP TO THE GLAZING BAR.

REPEAT FOR ALL CORNERS

CONTINUE ON NEXT PAGE

**\*WARNINGS\***  
**- DO NOT USE A CORDLESS DRILL DURING THIS STAGE-  
 OVER-TIGHTENING THE SCREWS CAN  
 CAUSE THE GLASS TO SHATTER**

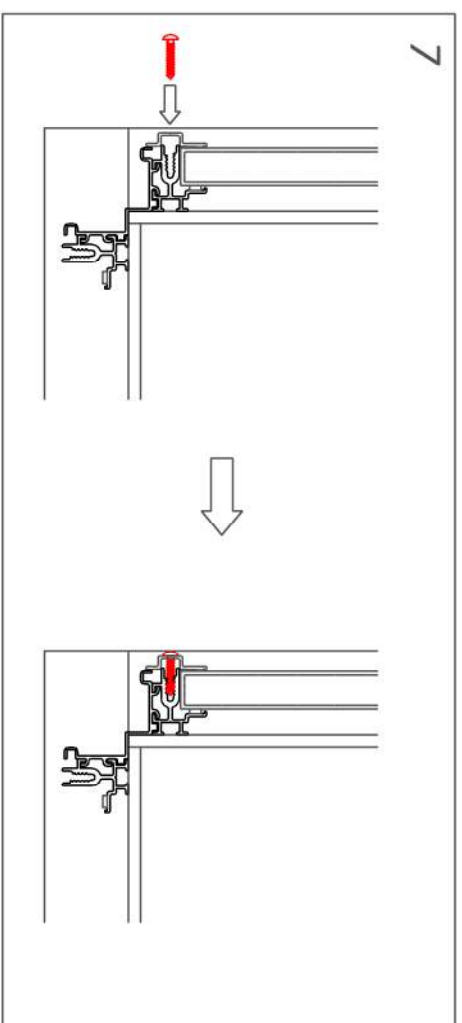
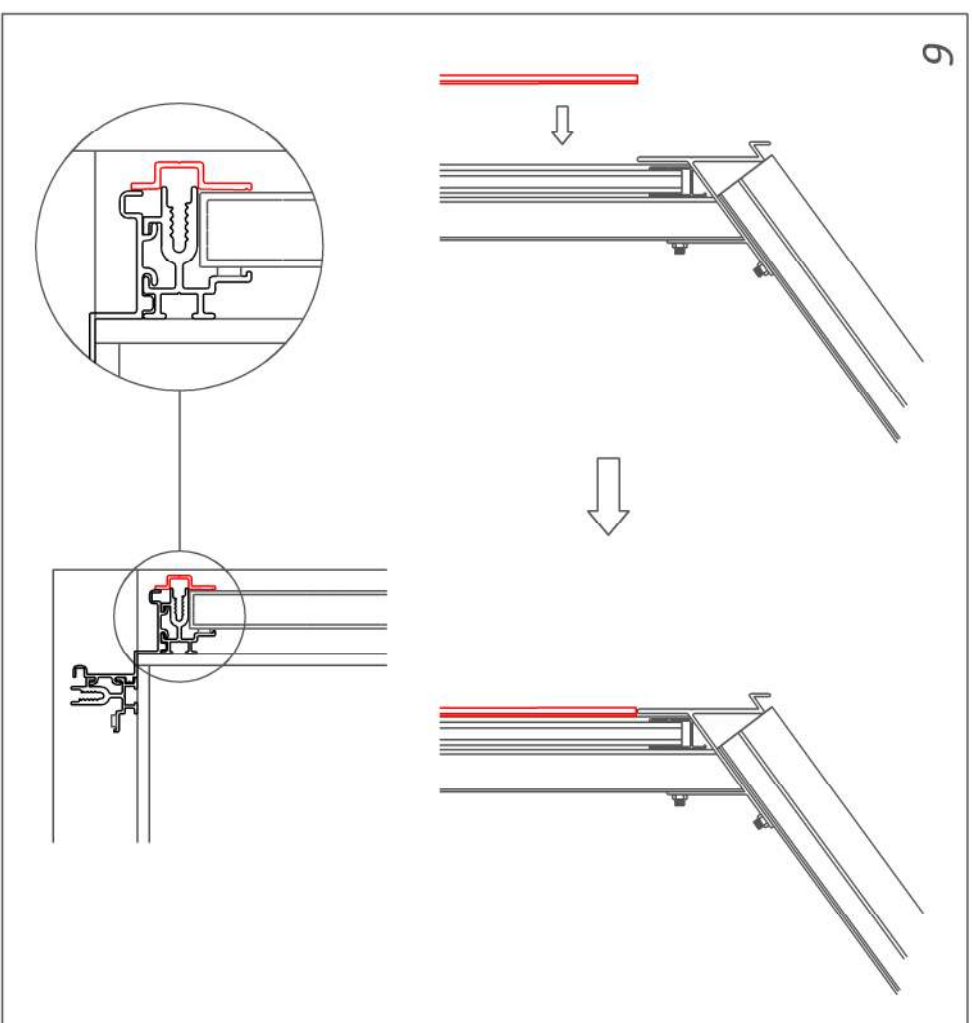
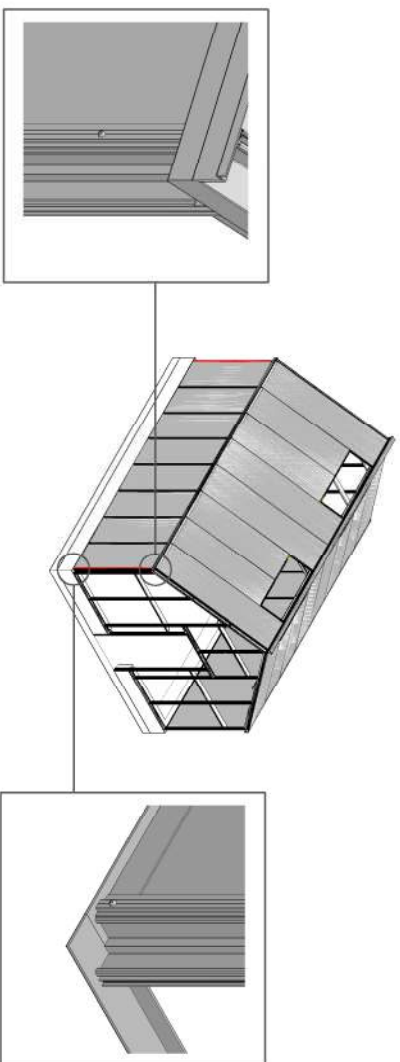

**PRO TIPS**

All Glazing Caps are cut and punched so that the holes will line up horizontally if installed right side up.

**Typical Ripped Glazing Cap (Side Wall)**

**Square Cut on top.**

**Square Cut on bottom.**

**Parts List:**

- Glazing Caps
- Glazing Caps (Ripped)
- h-Channels (Top)
- h-Channels (Bottom)
- 16mm Tempered Glass Panels
- Setting Blocks
- #8 x  $\frac{3}{4}$ " S.S. Screws

**PRO TIPS**



All Side Wall Caps should sit flush on top of the Base and be tight to the Gutter.

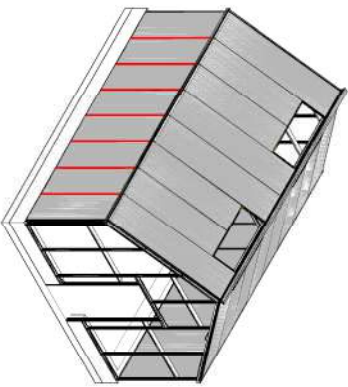

**STAGE 30D: SIDE WALL GLAZING - (16MM DOUBLE GLASS)**

**STEPS:**

- 8. PLACE THE CAP AGAINST THE GLASS PANEL
- 9. SECURE THE CAP TO THE GLAZING BAR.

REPEAT FOR ALL REMAINING CAPS

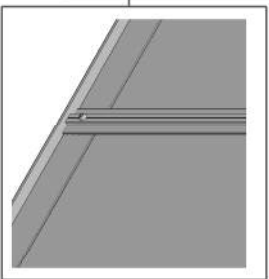
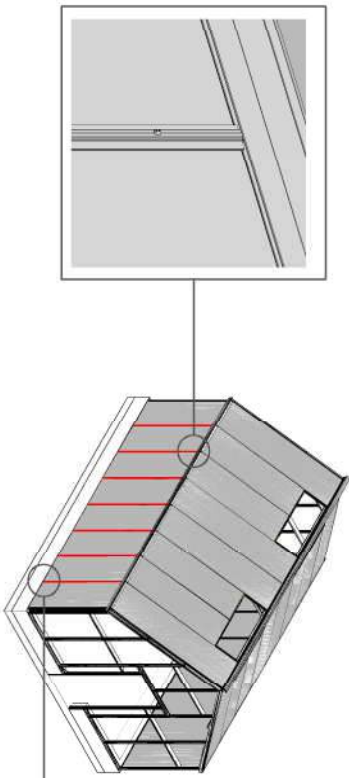
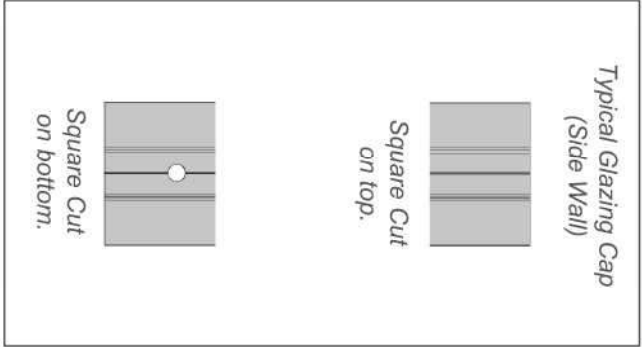
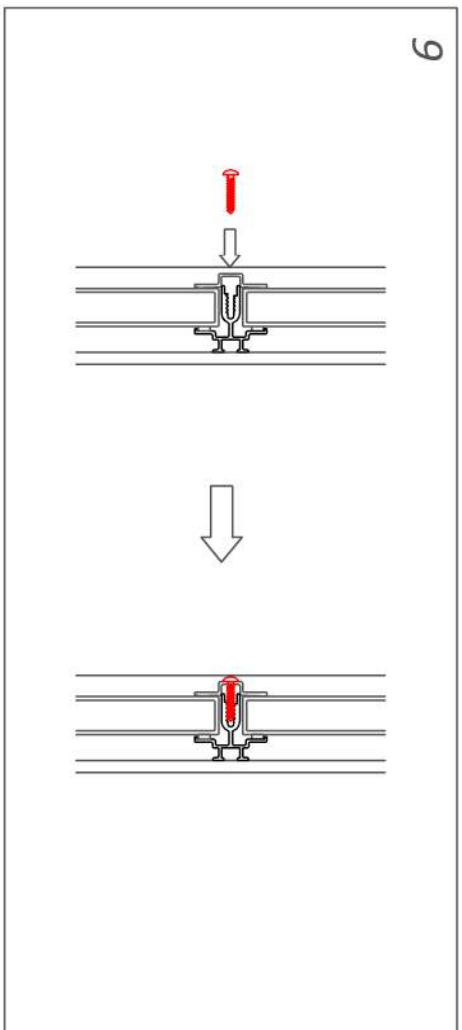
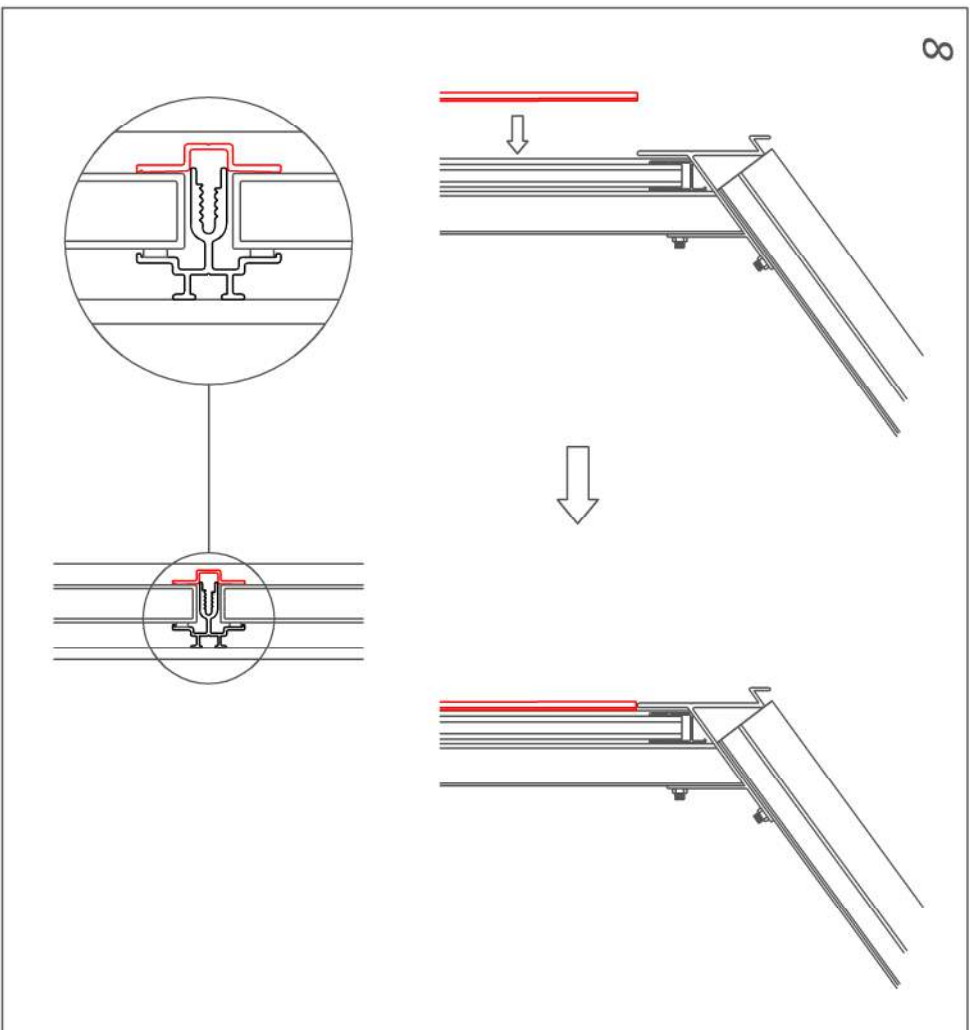

**Parts List:**

- Glazing Caps
- Glazing Caps (Ripped)
- h-Channels (Top)
- h-Channels (Bottom)
- 16MM Double Glass Panels
- Setting Blocks
- #8 x 3/4" S.S. Screws

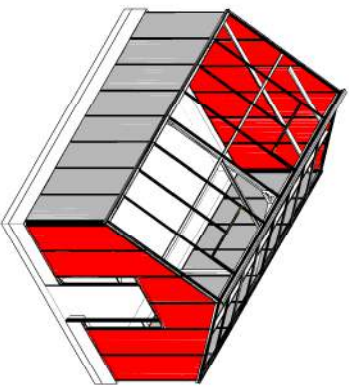

**STAGE 31A: GABLE GLAZING -  
(16MM DOUBLE GLASS)**

- STEPS:**
1. PEEL THE BROWN PAPER FROM THE FOAM TAPE ON THE SIDE WALL GLAZING BARS.
  2. PLACE THE H-CHANNELS & SETTING BLOCKS ONTO THE TOP & BOTTOM OF A GLASS PANEL
- CONTINUE ON NEXT PAGE

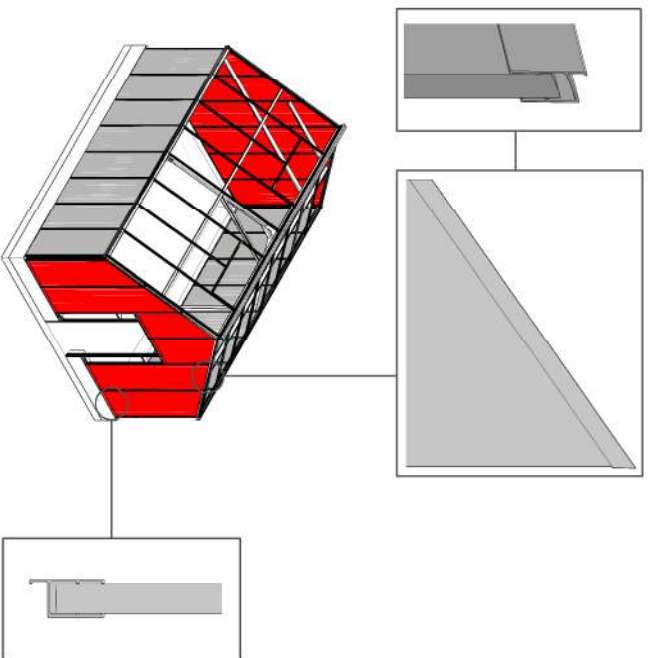

**1**

Peel paper from  
Foam Tape

**2**

H-Channel (No Holes)

Setting Blocks

H-Channel (w/ Holes)

Do Not cover holes.

Inside

Outside

**PRO TIPS**

*h-Channels for the top of the Gable Glass are cut at angle on both ends to match the roof pitch of the greenhouse.*







Typical Glass Panel  
(Gable Wall)

Angle Cut  
Left to Right  
on top.

Square Cut  
on bottom.

*Glazing Caps & h-Channels will come packaged specific to their location in the greenhouse. Open the Bundles only as you need them.*

**Parts List:**

-  Glazing Caps
-  Glazing Caps (Ripped)
-  h-Channels (Top)
-  h-Channels (Bottom)
-  16mm Double Glass Panels
-  Setting Blocks
- #8 x 3/4" S.S. Screws icon" data-bbox="60 790 80 805"/> #8 x  $\frac{3}{4}$ " S.S. Screws



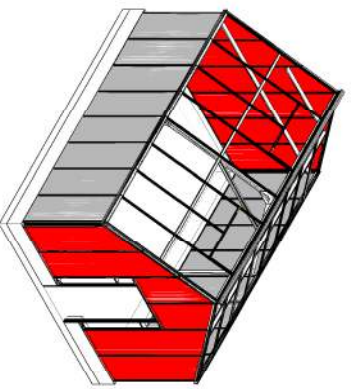





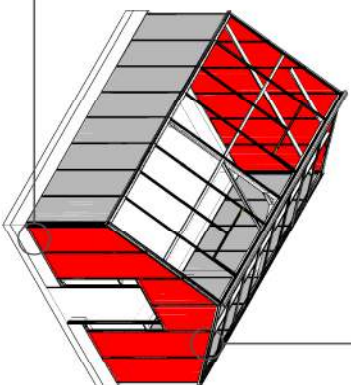
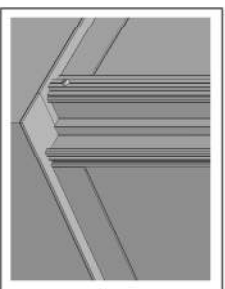
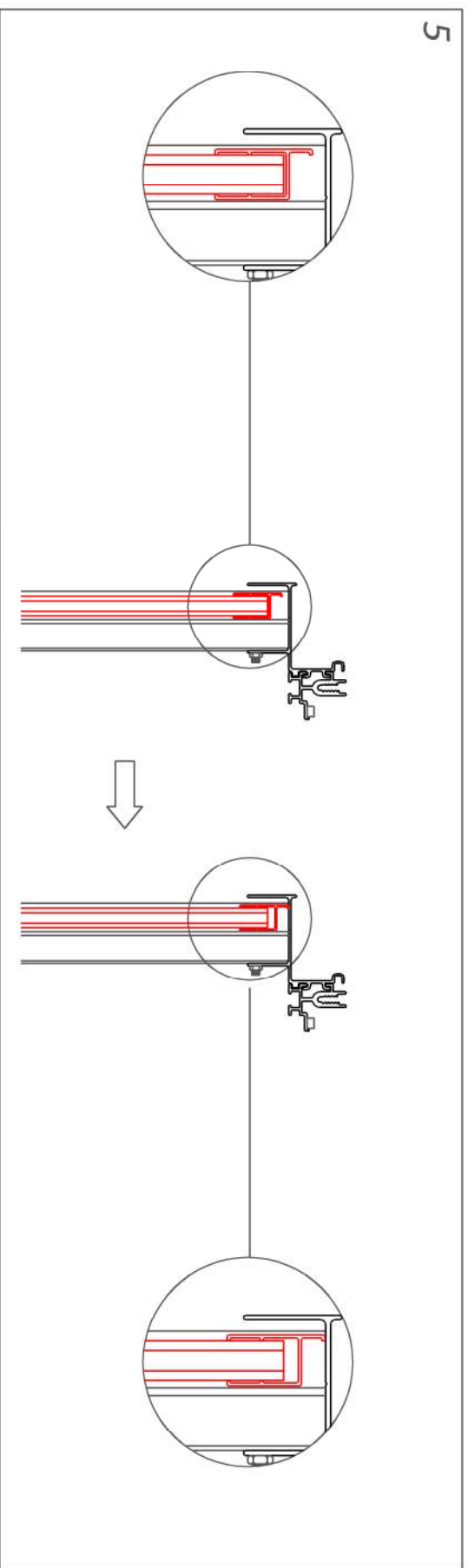
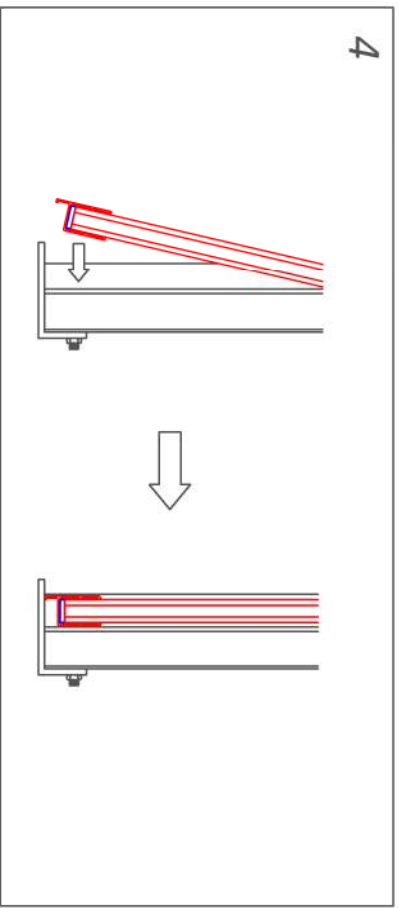
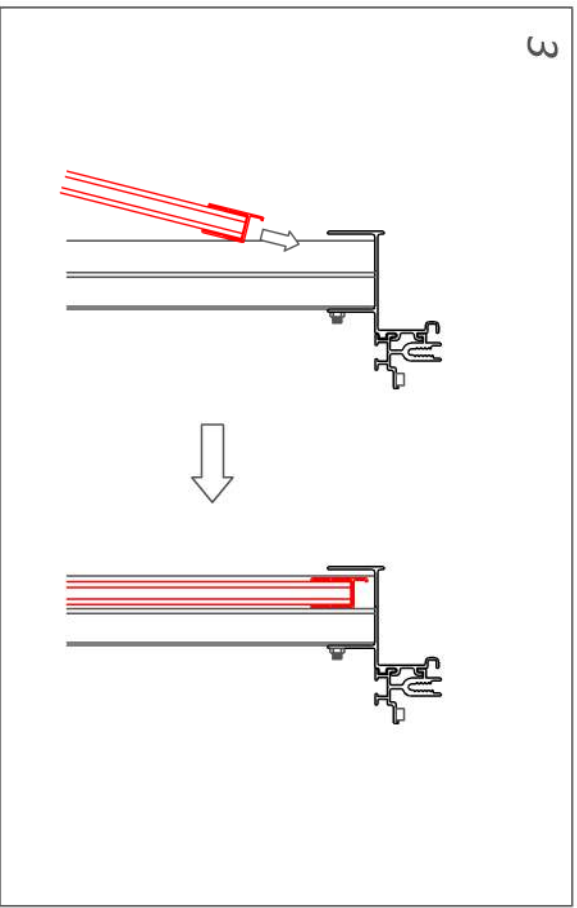

**STAGE 31B: GABLE GLAZING -  
(16MM DOUBLE GLASS)**

**STEPS:**

3. SLIP THE TOP OF THE GLASS PANEL BENEATH THE END RAFTER.
  4. PUSH THE BOTTOM OF THE GLASS PANEL INTO POSITION.
  5. PUSH THE TOP H-CHANNEL UP UNTIL IT TOUCHES THE UNDERSIDE OF THE END RAFTER.
- REPEAT FOR ALL ANGLE-CUT GABLE GLAZING  
CONTINUE ON NEXT PAGE



**Parts List:**

-  Glazing Caps
-  Glazing Caps (Ripped)
-  h-Channels (Top)
-  h-Channels (Bottom)
-  16mm Double Glass Panels
-  Setting Blocks
- #8 x 3/4" S.S. Screws icon" data-bbox="65 795 85 815"/> #8 x 3/4" S.S. Screws

**PRO TIPS**



Start by glazing the 4 corners on the gable walls of the greenhouse. This will help to square the frame from left to right.

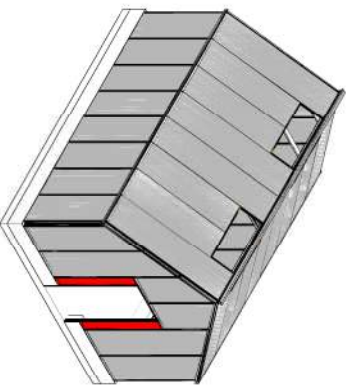

**STAGE 31C: BESIDE DOOR GLAZING -  
(16MM DOUBLE GLASS)**

- STEPS:**
6. FILL THE GAP BETWEEN THE BASE & THE DOOR FRAME WITH CAULKING.
  7. PLACE THE H-CHANNELS ONTO THE TOP, BOTTOM & ONE SIDE OF THE NARROW GLASS PANELS INTENDED FOR BESIDE THE DOOR.
  8. SLIP THE LONG H-CHANNELS INTO THE TRACK ON THE SIDE OF THE DOOR FRAME & ROTATE INTO POSITION.
  9. PUSH THE TOP H-CHANNEL UP UNTIL IT TOUCHES THE BOTTOM OF THE DOOR HEADER.
- CONTINUE ON NEXT PAGE

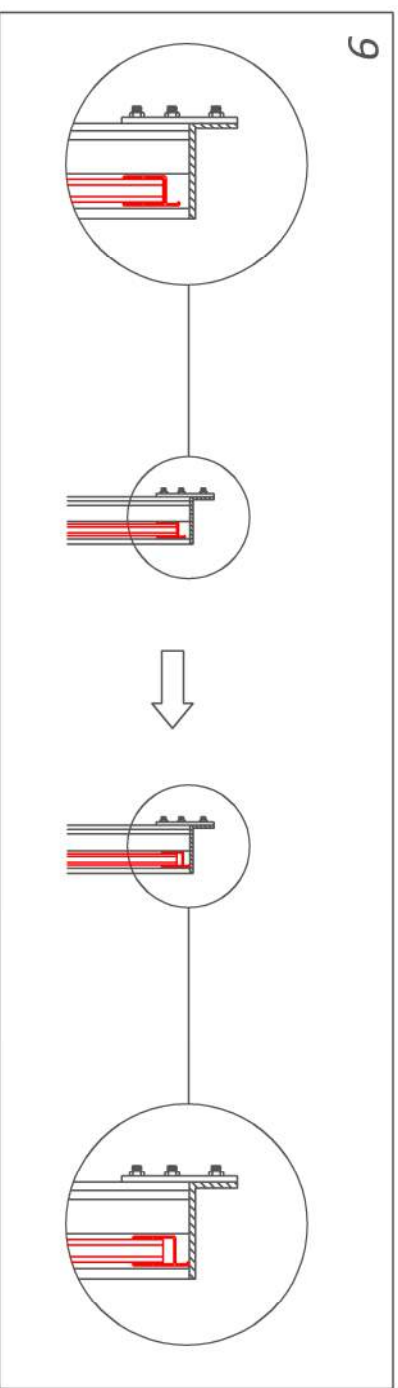
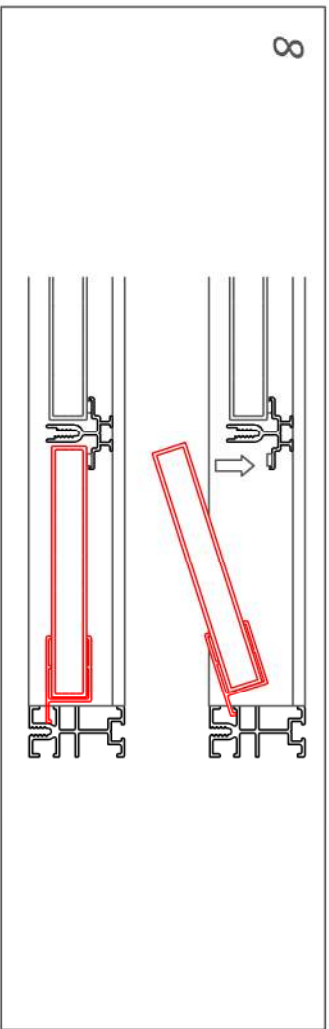
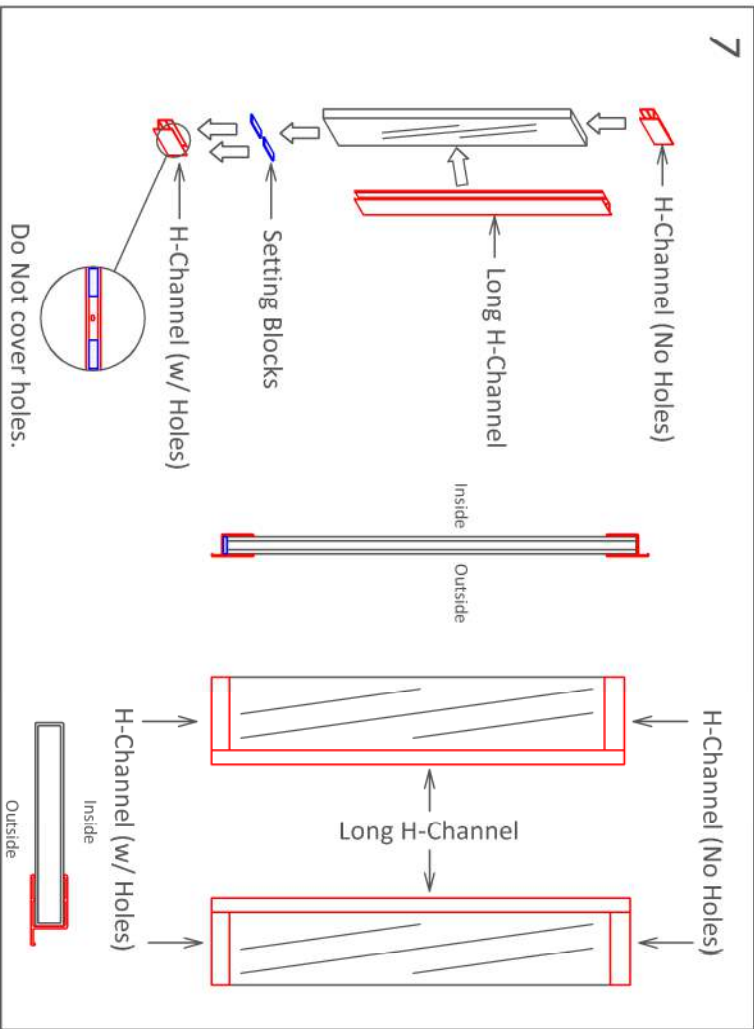
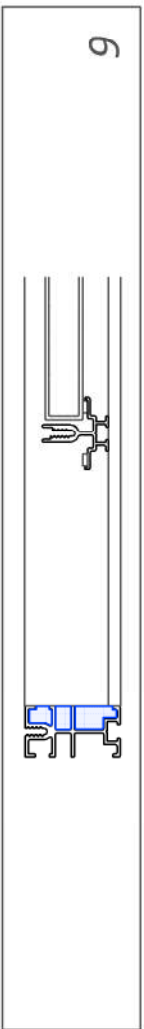
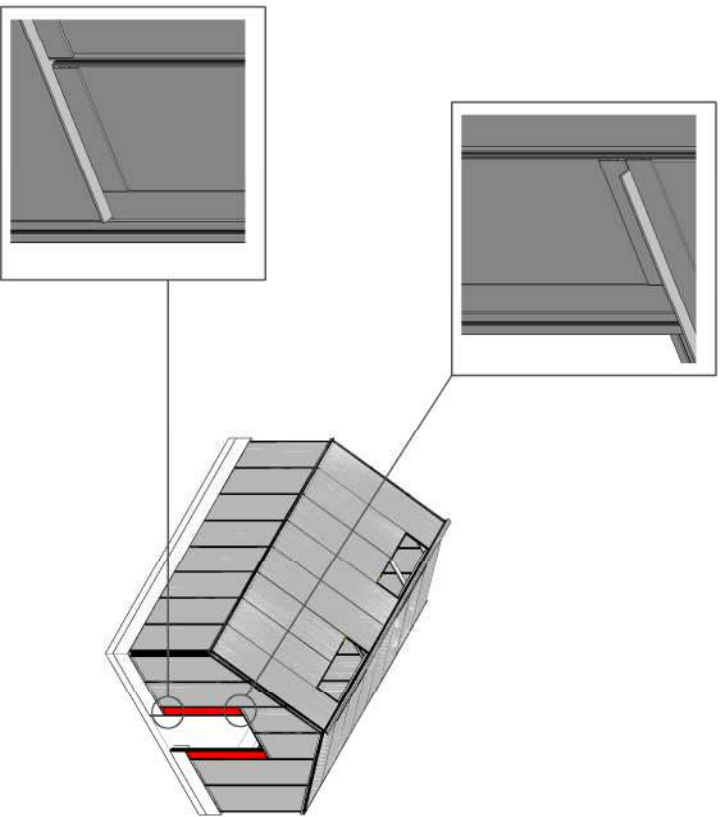

**PRO TIPS**

The Long h-Channels for this step were packaged with the rest of the Door Frame installed during Stage 3 of the Assembly process.

Typical Polycarbonate (Beside Door)

Square Cut on top.

Square Cut on bottom.

**Parts List:**

- Glazing Caps
- Glazing Caps (Ripped)
- h-Channels (Top)
- h-Channels (Bottom)
- 16mm Double Glass Panels
- Setting Blocks
- #8 x 3/4" S.S. Screws
- Caulking

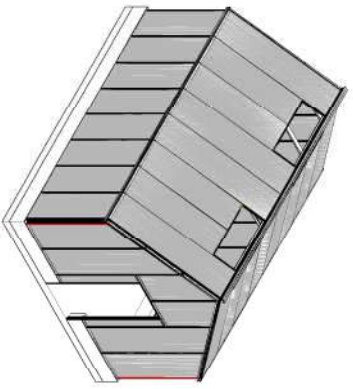

**STAGE 31D: GABLE CORNER CAPS -  
(16MM DOUBLE GLASS)**

STEPS:





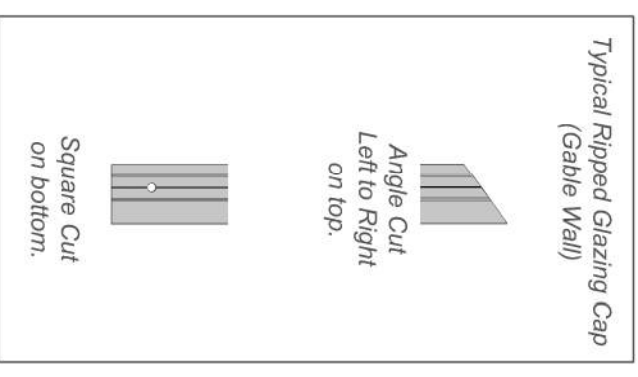
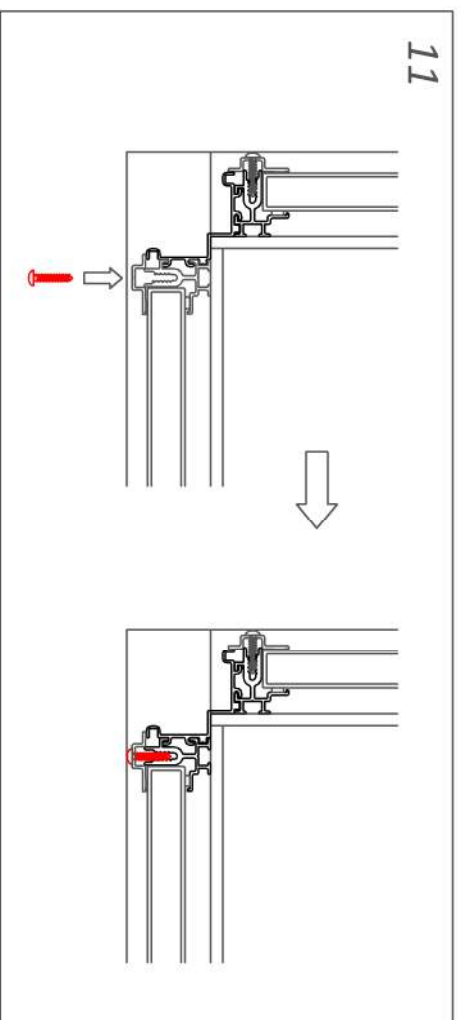
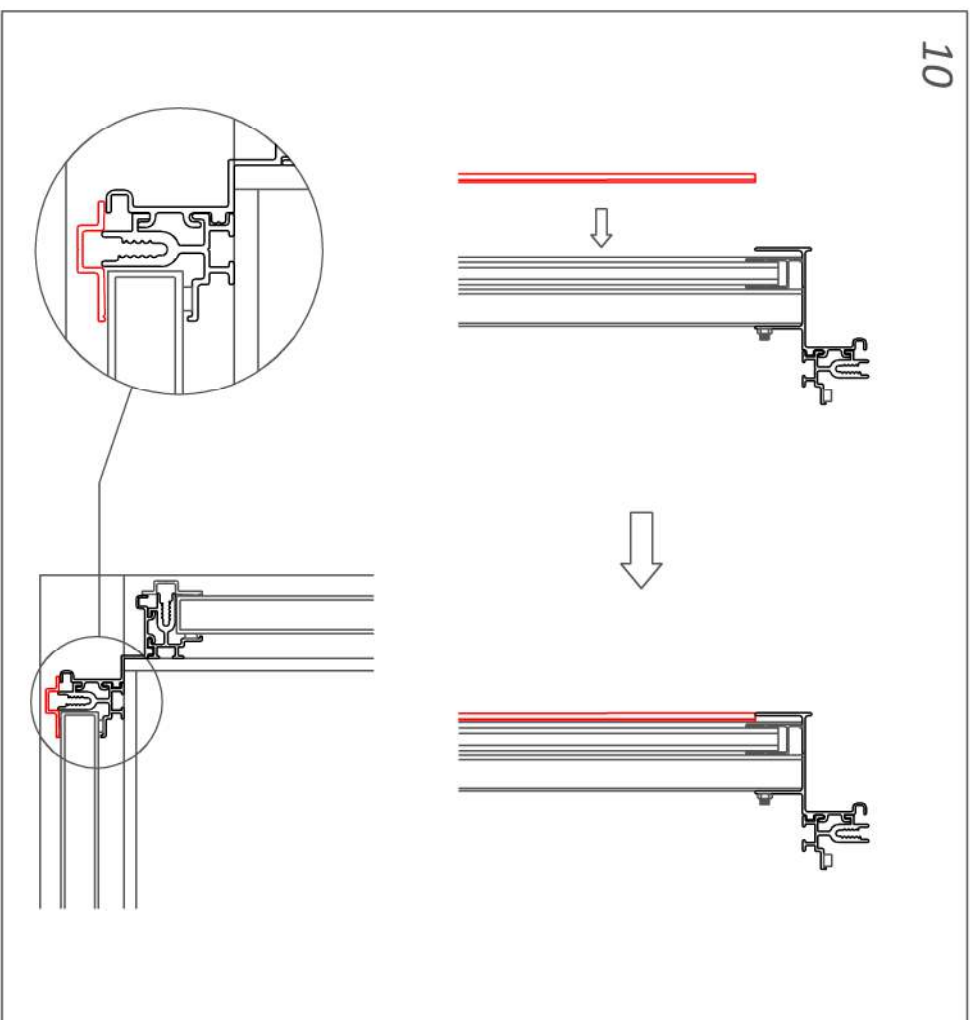
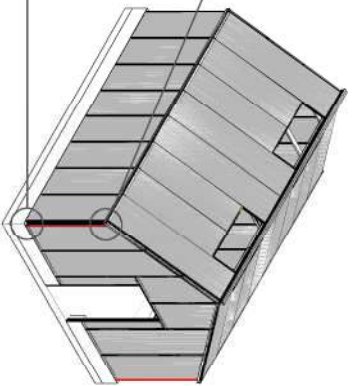
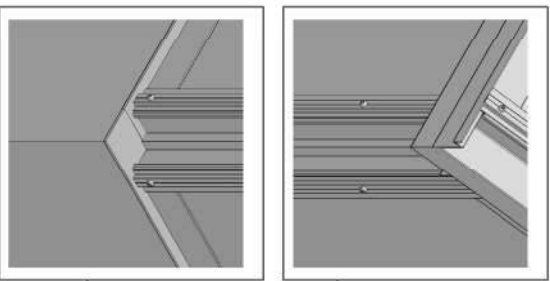

- 10. PRESS THE RIPPED CAP AGAINST THE GLAZING BAR & CORNER POST.
- 11. SECURE THE CAP TO THE GLAZING BAR.

REPEAT FOR ALL CORNERS

CONTINUE ON NEXT PAGE



**Parts List:**

-  Glazing Caps
-  Glazing Caps (Ripped)
-  h-Channels (Top)
-  h-Channels (Bottom)
-  16MM Double Glass Panels
-  Setting Blocks
-  #8 x  $\frac{3}{4}$ " S.S. Screws

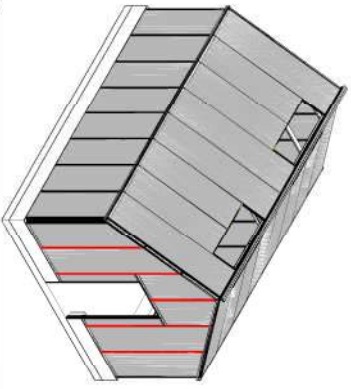





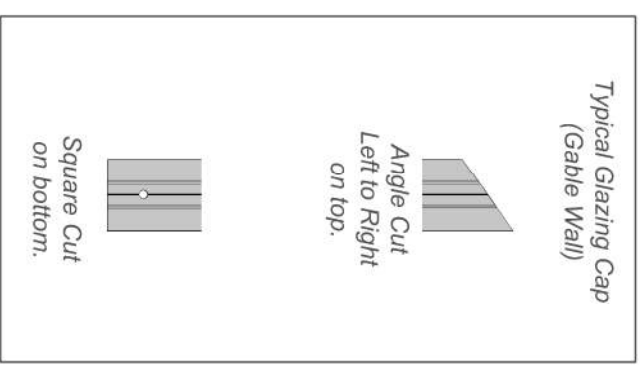
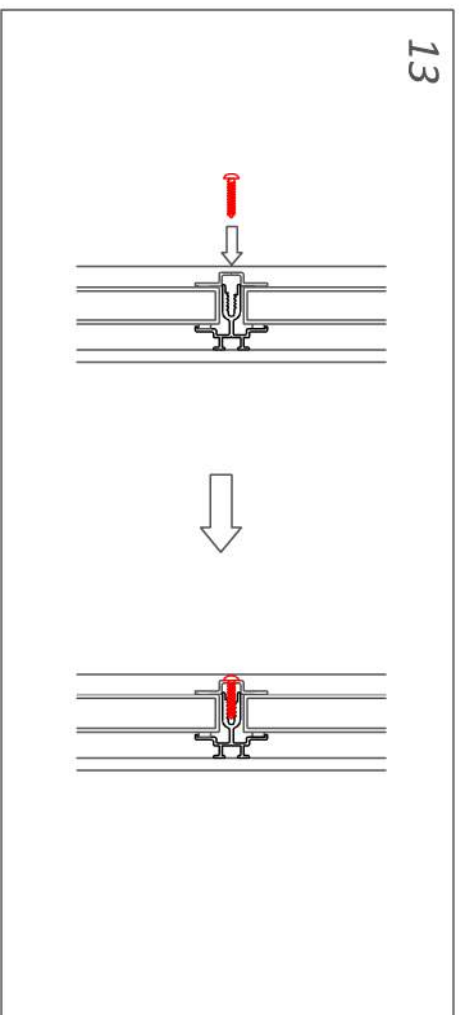
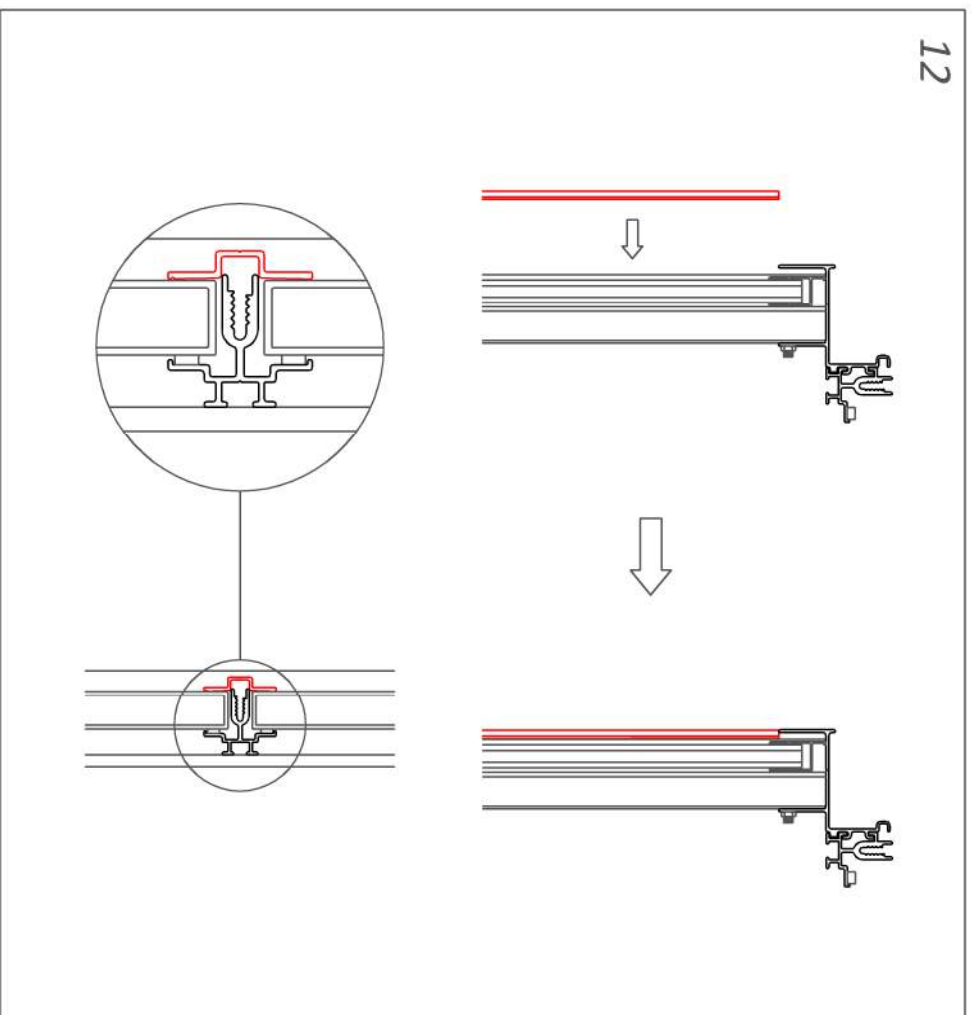
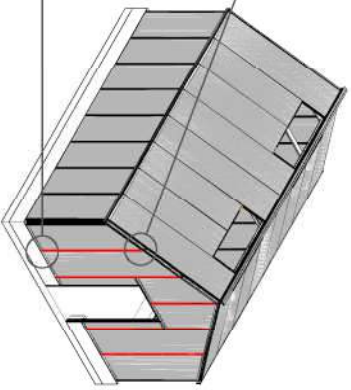
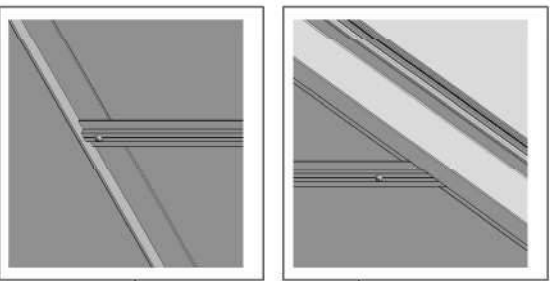

**STAGE 31E: GABLE CAPS - (16MM DOUBLE GLASS)**

STEPS:

- 12. PRESS THE CAP AGAINST THE GLAZING BAR.
  - 13 SECURE THE CAP TO THE GLAZING BAR.
- REPEAT FOR ALL REMAINING CAPS



Parts List:

-  Glazing Caps
-  Glazing Caps (Ripped)
-  h-Channels (Top)
-  h-Channels (Bottom)
-  16mm Double Glass Panels
-  Setting Blocks
-  #8 x  $\frac{3}{4}$ " S.S. Screws

**STAGE 32: SEALING -  
(16MM DOUBLE GLASS)**

- CLEAR SILICONE (PROGLAZE)
- COLORED CAULKING (TREMCO 830)

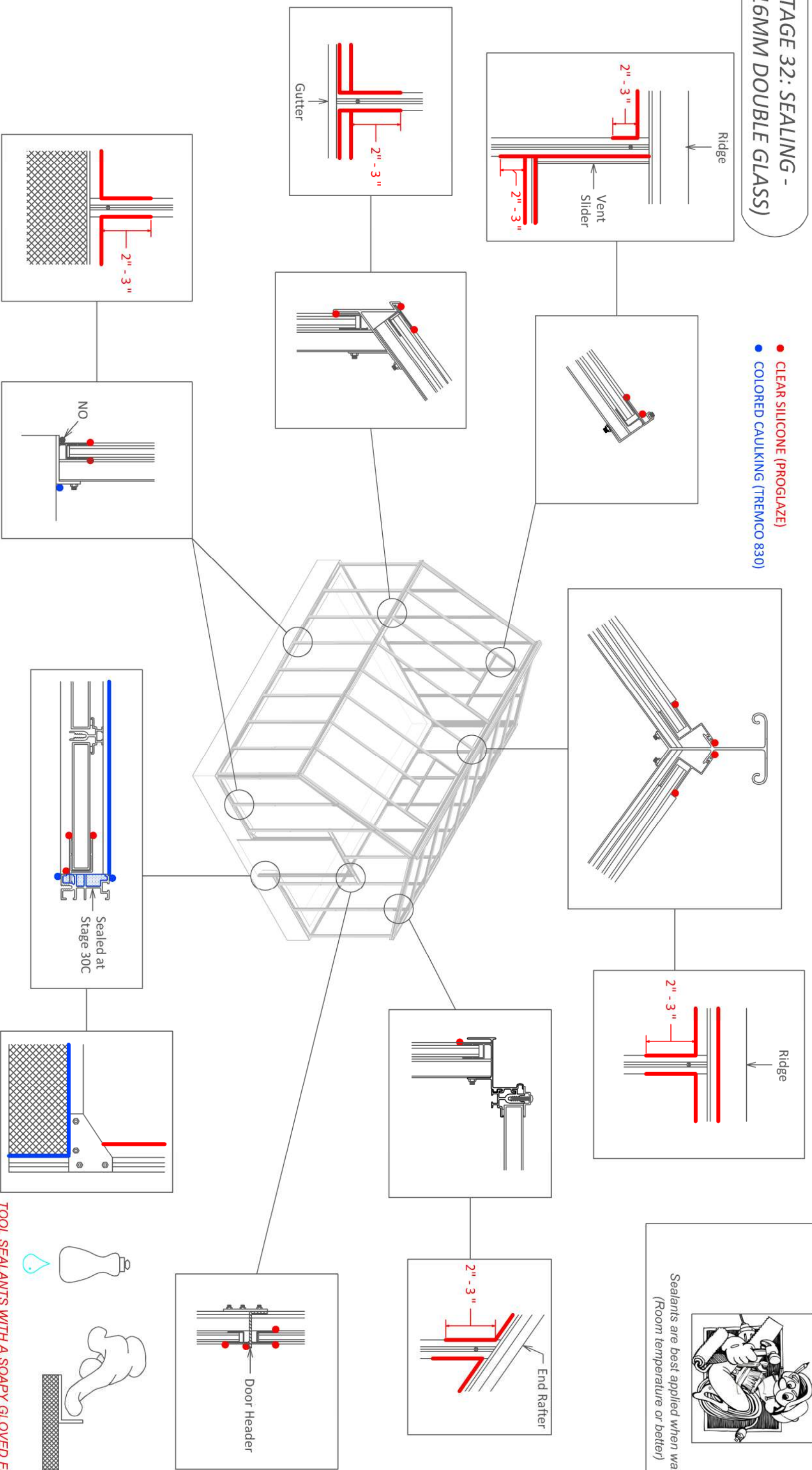

Sealants are best applied when warm  
(Room temperature or better)



**PRO TIPS**

TOOL SEALANTS WITH A SOAPY GLOVED FINGER  
OR A CAULK-SMOOTHING TOOL.

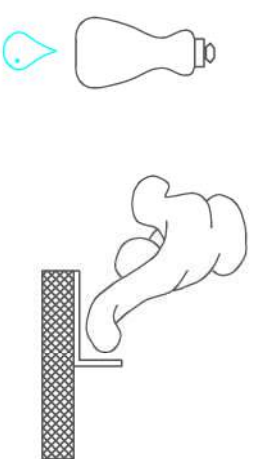

**Parts List:**





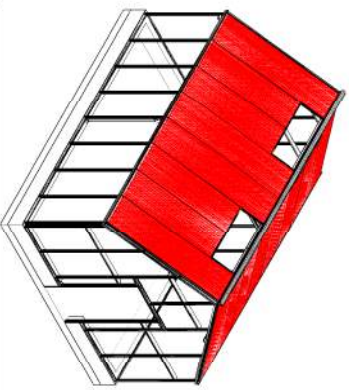

GLAZE & CAP THE ROOF IN ORDER FROM BACK TO FRONT AND THEN FRONT TO BACK. COMPLETE ONE SIDE BEFORE BEGINNING THE NEXT.

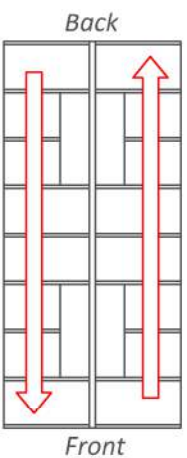

STAGE 33A: ROOF GLAZING - (6MM SINGLE GLASS)

- STEPS:**
1. PEEL THE BROWN PAPER FROM THE FOAM TAPE ON THE ROOF GLAZING BARS.
  2. PLACE THE H-CHANNEL ON THE BOTTOM OF A GLASS PANEL
- CONTINUE ON NEXT PAGE

1

Peel paper from Foam Tape

2

**PRO TIPS**

Have one person working outside the greenhouse and one on the inside to help fit the glass panels into the Ridge.

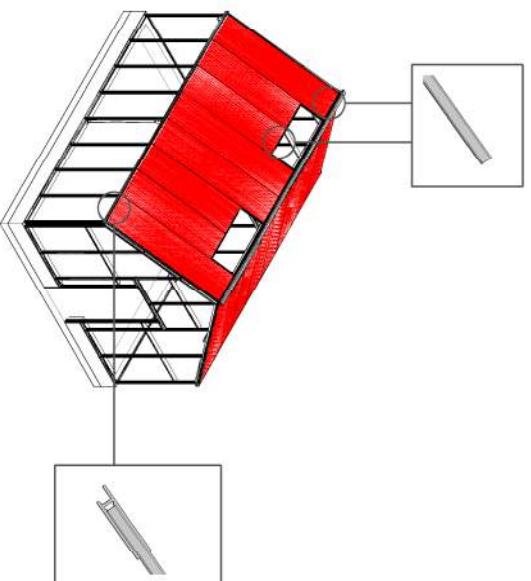

Parts List:



Glazing Caps



Glazing Caps (Ripped)



h-Channels



6mm Single Glass Panels



#8 x 5/8" S.S. Screws

Glazing Caps & h-Channels will come packaged specific to their location in the greenhouse. Open the Bundles only as you need them.



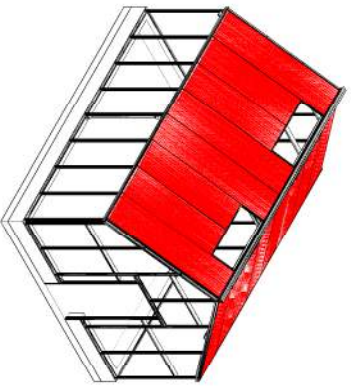

**STAGE 33B: ROOF GLAZING -  
(6MM SINGLE GLASS)**

**STEPS:**

- 3. INSERT THE TOP OF THE GLASS PANEL INTO THE RIDGE.
- 4. INSERT THE H-CHANNEL AT THE BOTTOM OF THE PANEL INTO THE GUTTER.
- REPEAT
- 5. INSERT THE TOP OF THE GLASS PANEL INTO THE VENT FRAME BOTTOM.
- 6. REPEAT STEP 4.
- REPEAT

CONTINUE ON NEXT PAGE

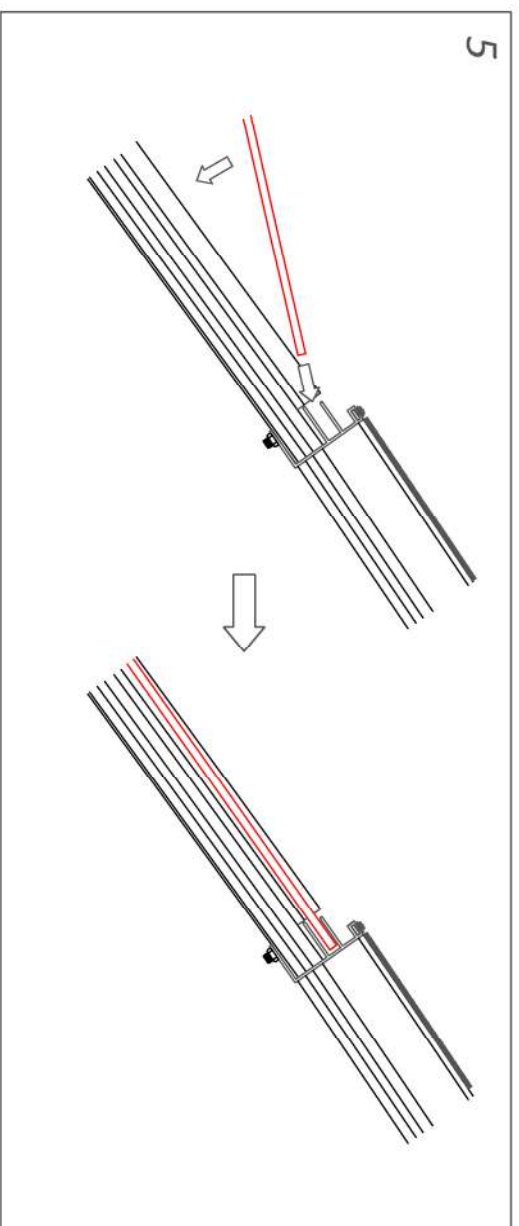
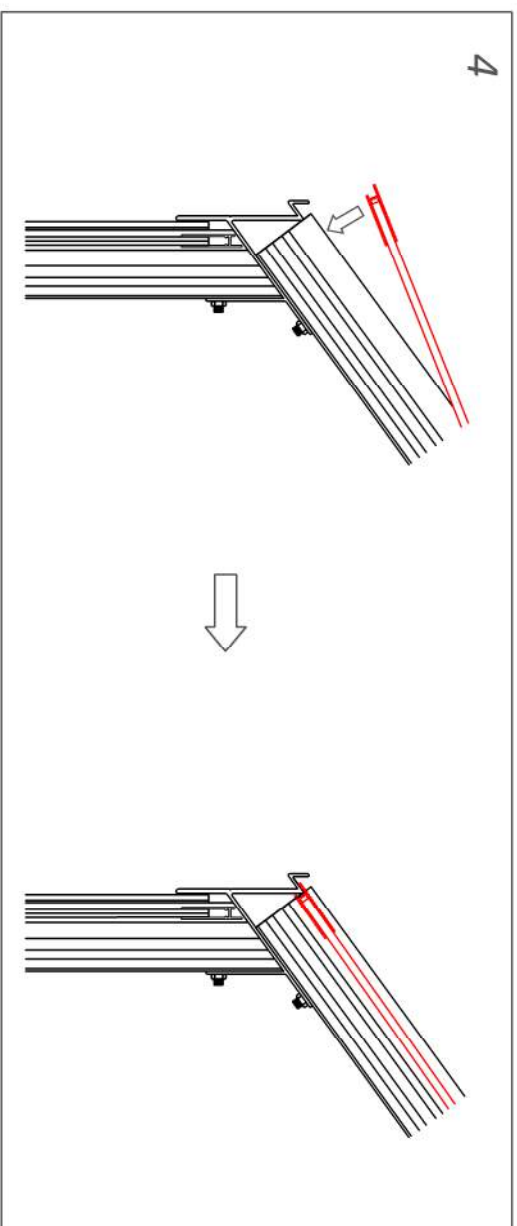
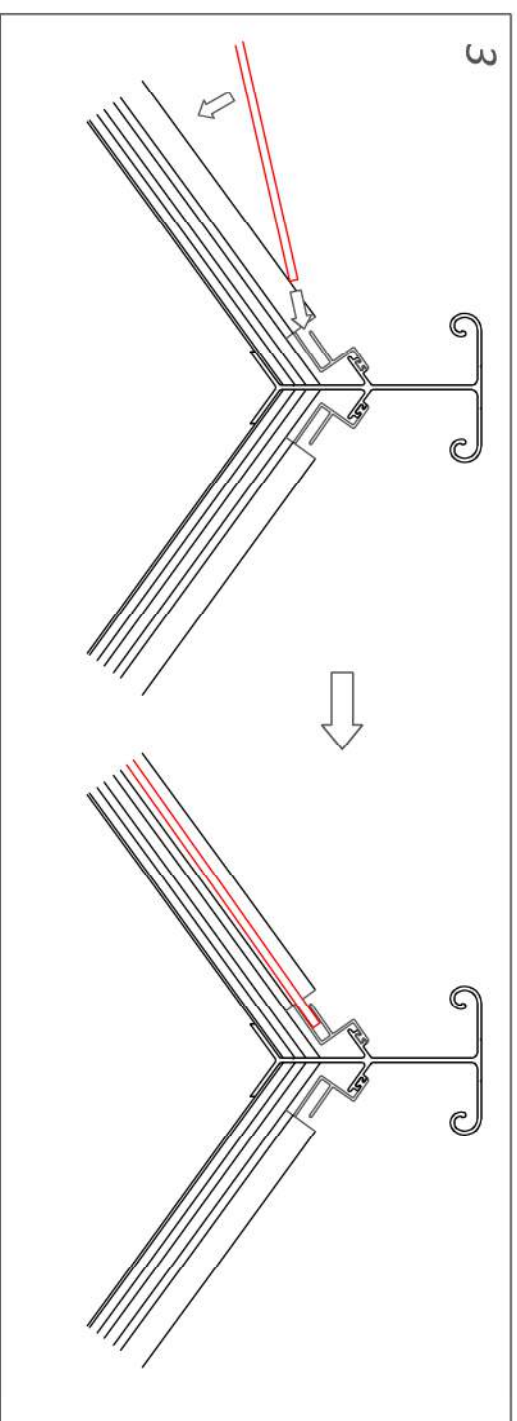
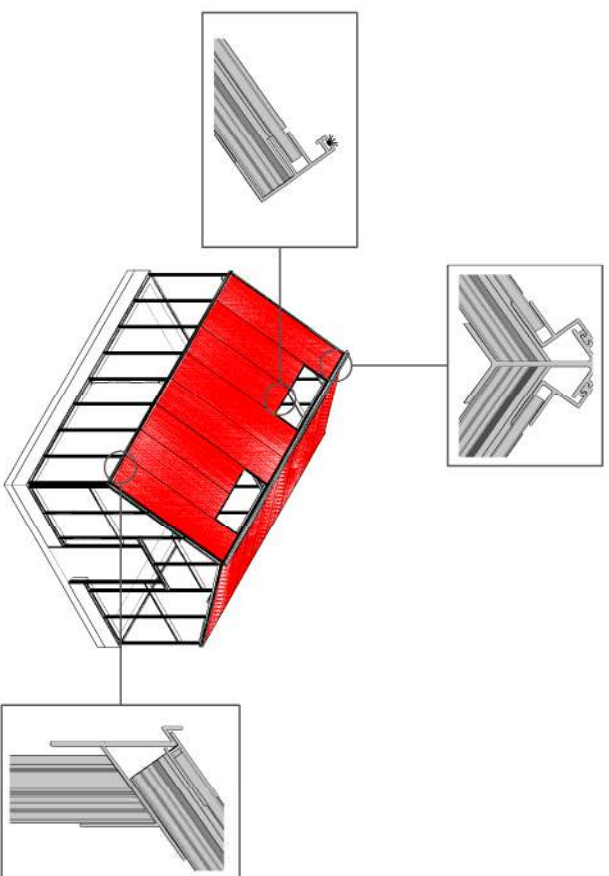

**Parts List:**



Glazing Caps



Glazing Caps (Ripped)



h-Channels



6mm Single Glass Panels



#8 x 5/8" S.S. Screws

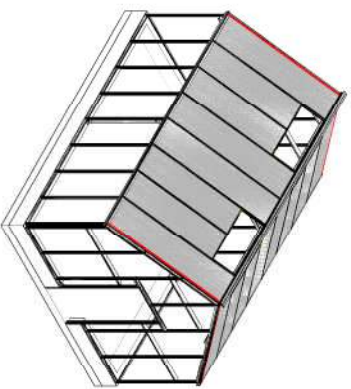

**STAGE 33C: ROOF END CAPS-  
(6MM SINGLE GLASS)**

- STEPS:**
7. LAY THE RIPPED CAP ON THE END GLAZING BAR AND TUCK BENEATH THE END RAFTER. (CAP SHOULD SIT TIGHT TO THE GUTTER)
  8. SECURE THE CAP TO THE GLAZING BAR.
- REPEAT FOR ALL CORNERS  
CONTINUE ON NEXT PAGE

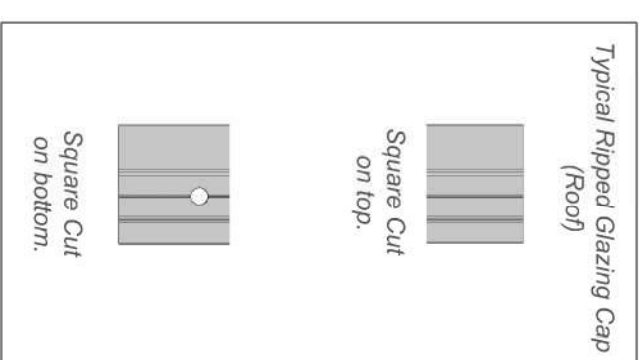
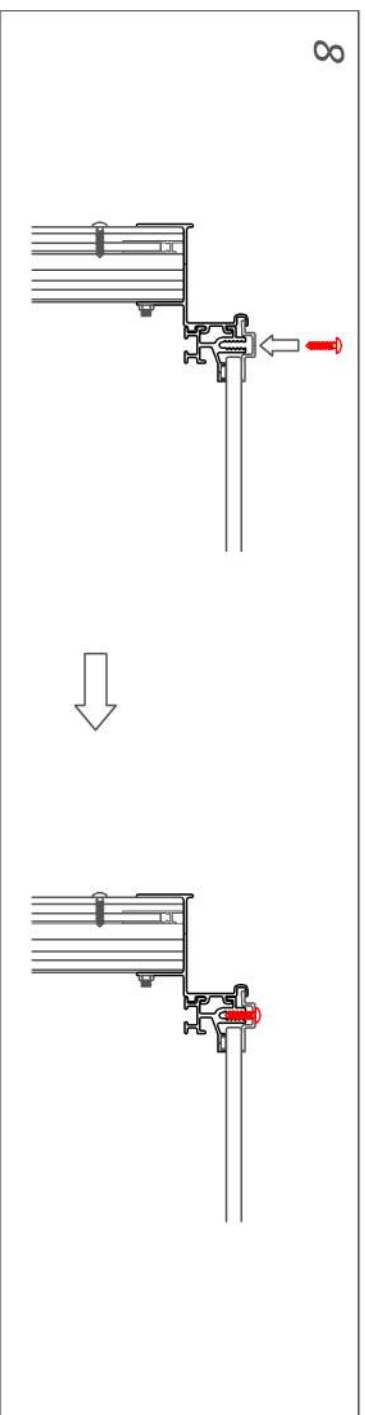
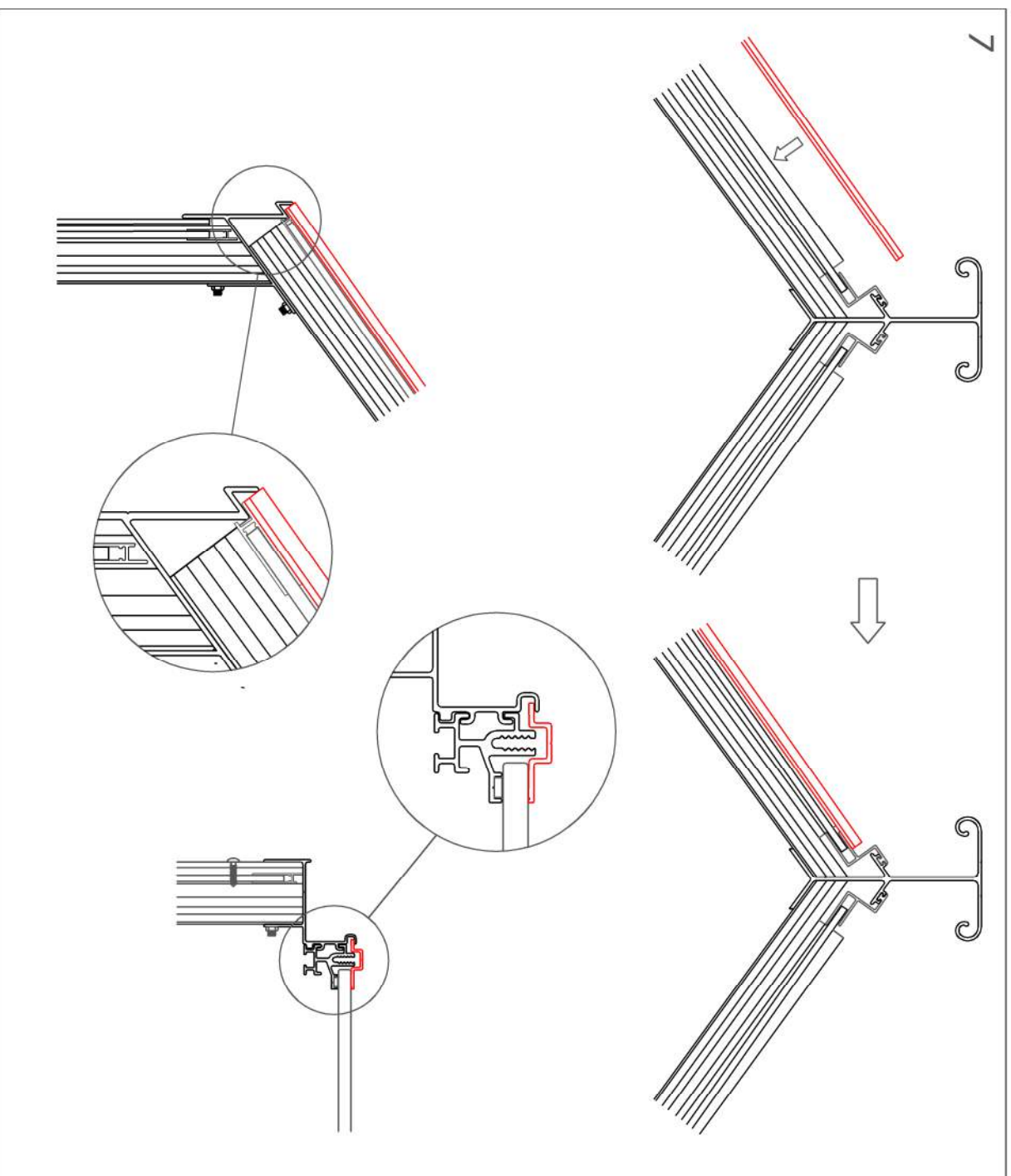
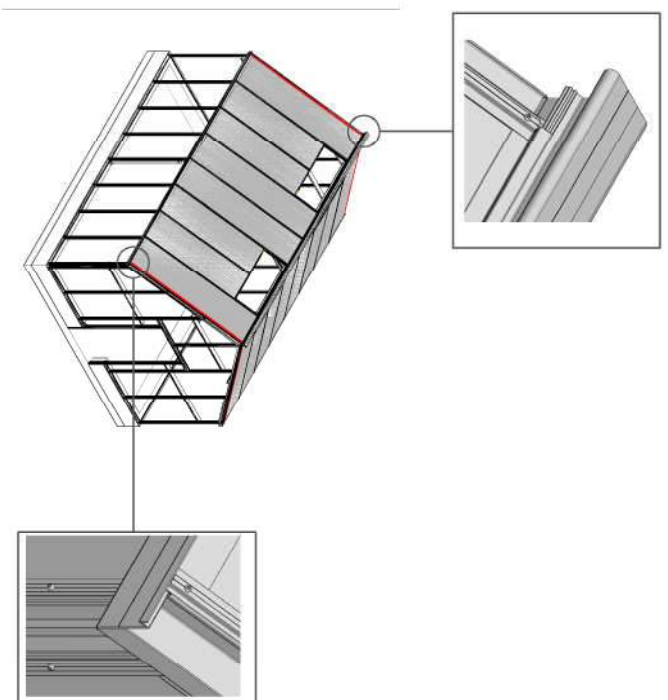

**Parts List:**



Glazing Caps



Glazing Caps (Ripped)



h-Channels



6mm Single Glass Panels



#8 x  $\frac{5}{8}$ " S.S. Screws

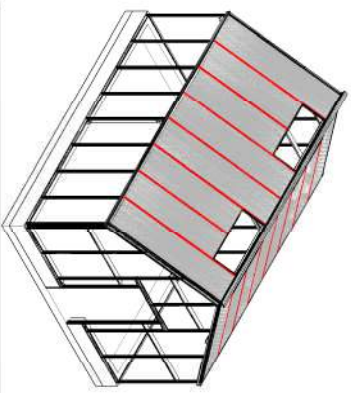

**STAGE 33D: ROOF GLAZING -  
(6MM SINGLE GLASS)**

- STEPS:**  
 9. LAY THE CAP ON THE GLAZING BAR (CAP SHOULD SIT TIGHT TO THE GUTTER)  
 10. SECURE THE CAP TO THE GLAZING BAR.  
 REPEAT FOR ALL REMAINING ROOF CAPS

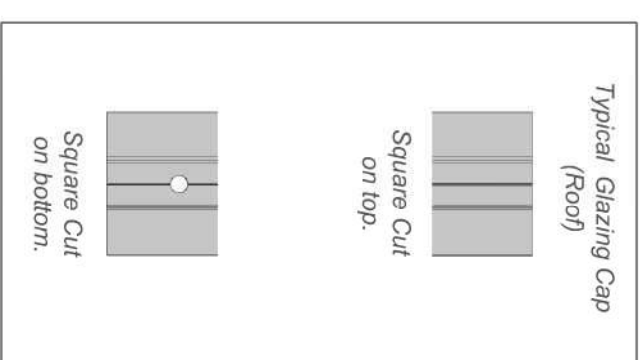
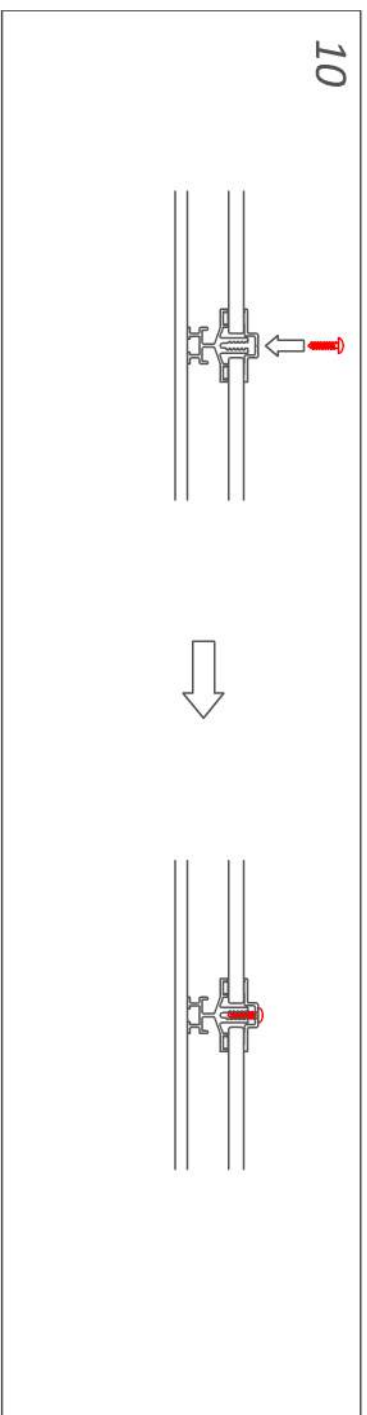
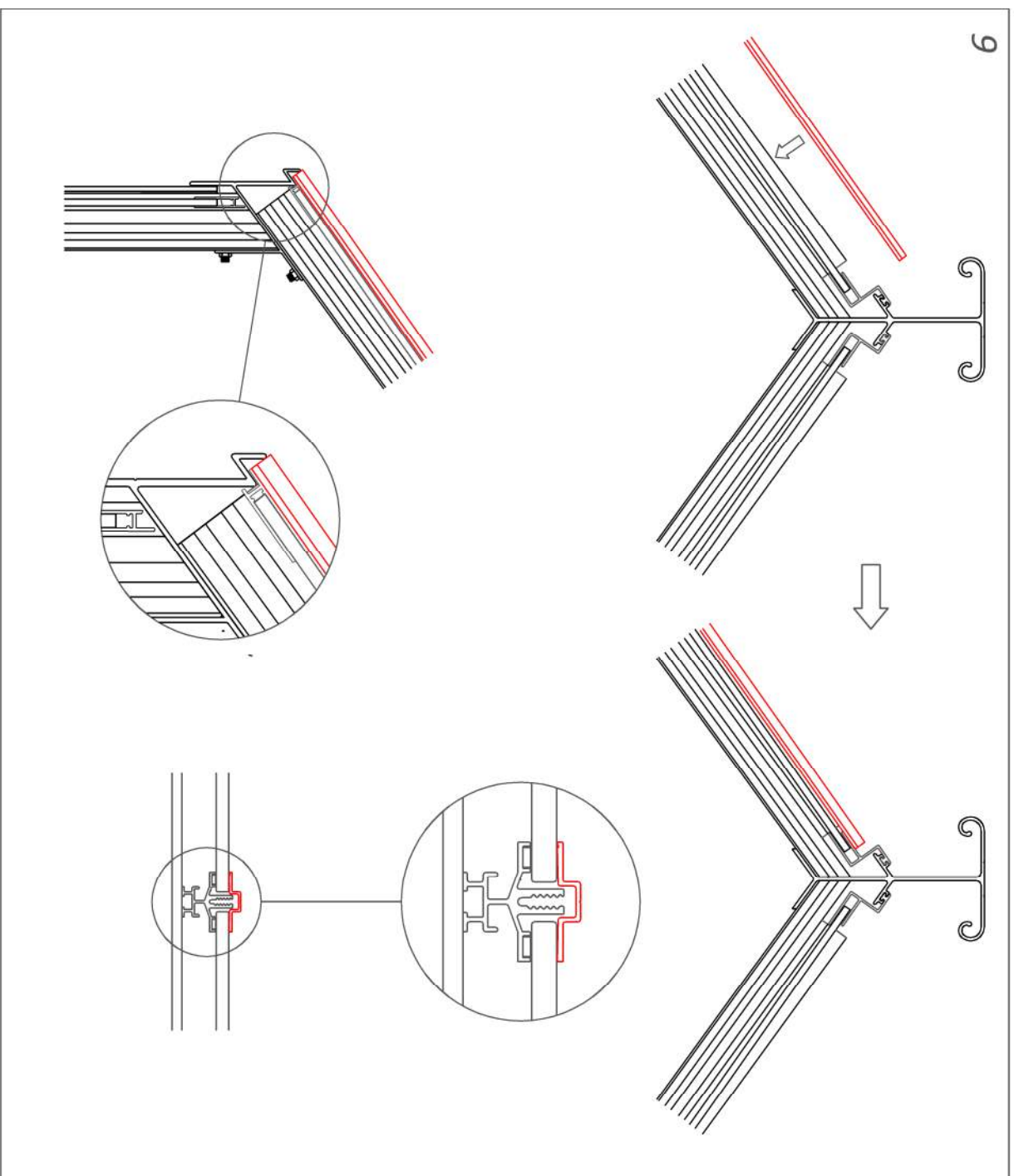
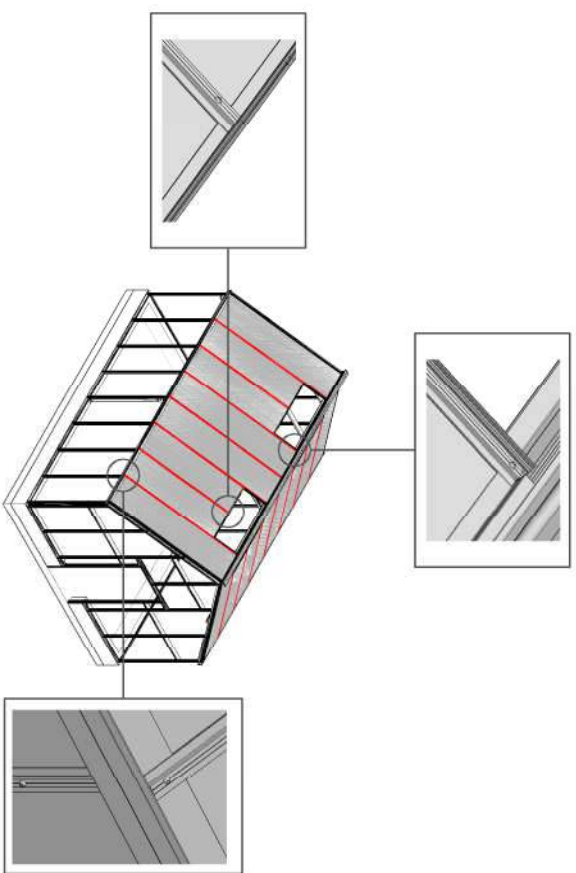

**Parts List:**



Glazing Caps



Glazing Caps (Ripped)



h-Channels



Twinwall Polycarbonate Panels



#8 x 5/8" S.S. Screws

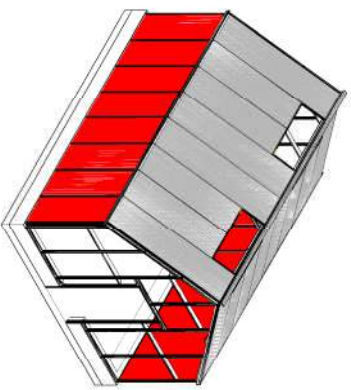

STAGE 34A: SIDE WALL GLAZING - (6MM SINGLE GLASS)

- STEPS:**
1. PEEL THE BROWN PAPER FROM THE FOAM TAPE ON THE SIDE WALL GLAZING BARS.
  2. PLACE THE H-CHANNEL ON THE TOP OF A GLASS PANEL.
- CONTINUE ON NEXT PAGE

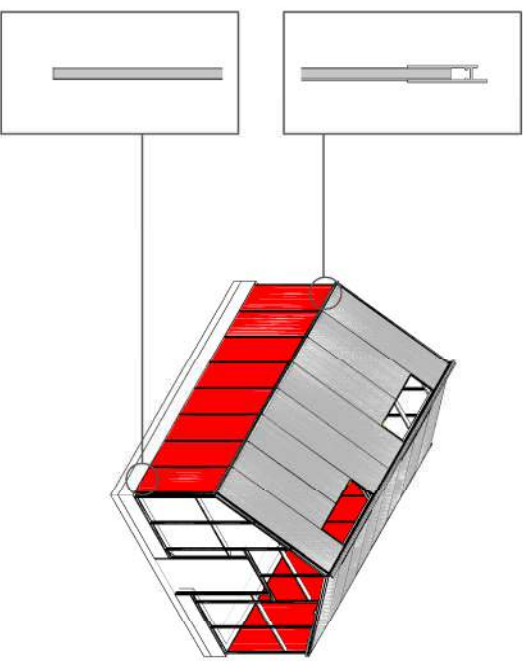

Parts List:



Glazing Caps



Glazing Caps (Ripped)



h-Channels



6mm Single Glass Panels



#8 x 5/8" S.S. Screws

1

Peel paper from Foam Tape

2

**PRO TIPS**

Your greenhouse will come with a glass map showing the size and location of every piece of glass.

*On hot days, you may find that the Glazing Foam is too sticky. Spraying the foam with a light soapy water will make installing the Glass easier.*

Glazing Caps & h-Channels will come packaged specific to their location in the greenhouse. Open the Bundles only as you need them.

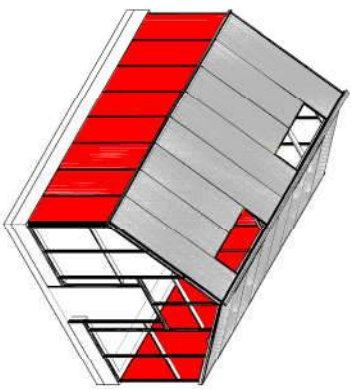

### STAGE 34B: SIDE WALL GLAZING - (6MM SINGLE GLASS)

**STEPS:**

3. SLIP THE TOP OF THE GLASS PANEL BENEATH THE GUTTER.
4. PUSH THE BOTTOM OF THE GLASS PANEL INTO POSITION.
5. PUSH THE TOP H-CHANNEL UP UNTIL IT TOUCHES THE UNDERSIDE OF THE GUTTER.

REPEAT FOR ALL SIDE WALL GLAZING

CONTINUE ON NEXT PAGE

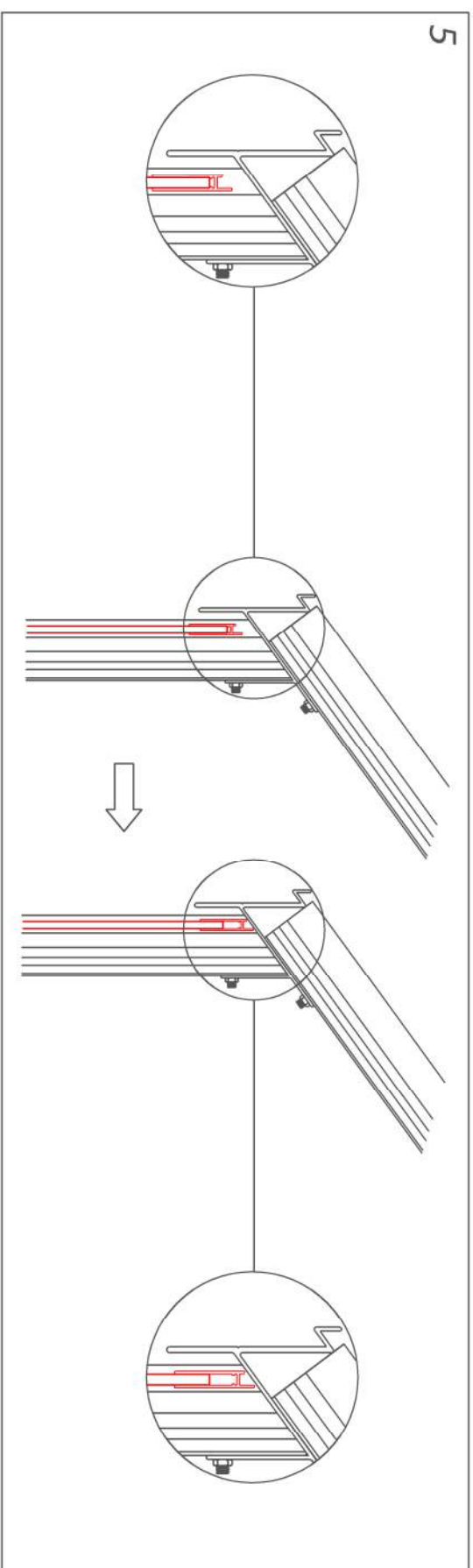
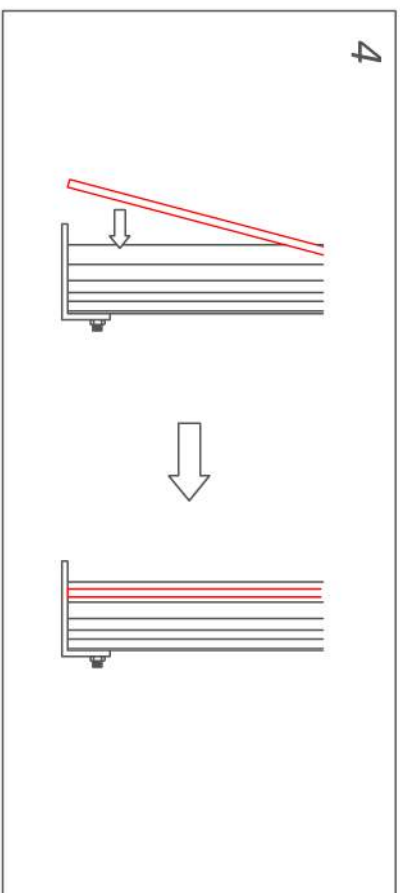
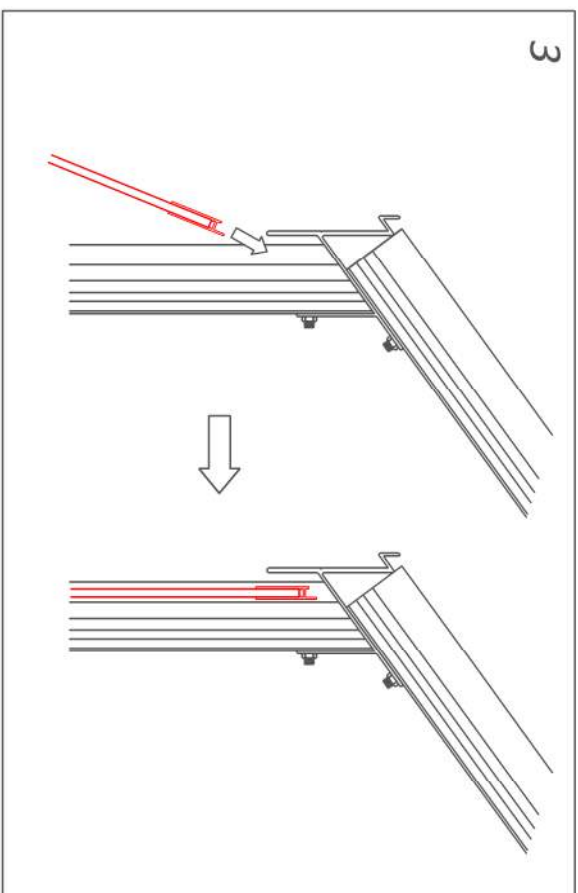
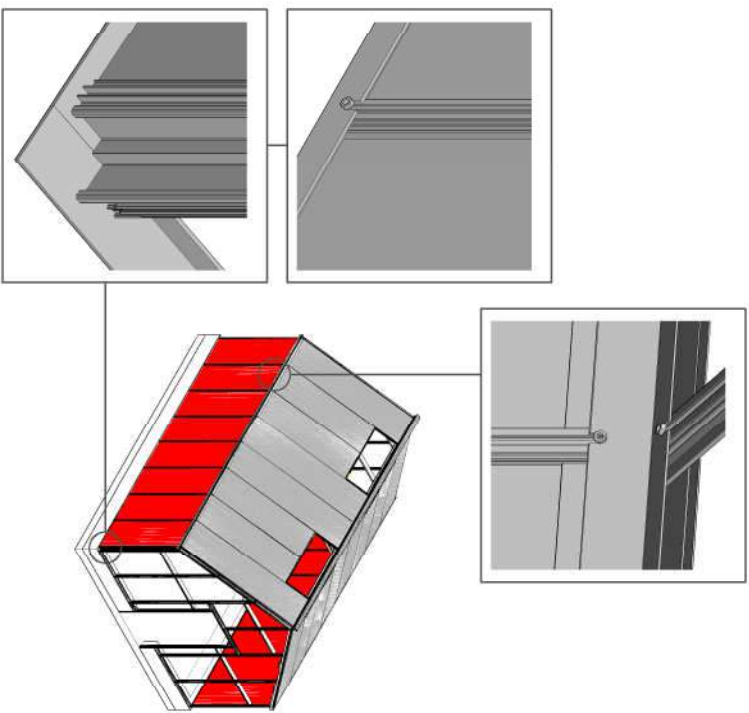

**Parts List:**



Glazing Caps



Ripped Glazing Caps



h-Channels



6mm Single Glass Panels



#8 x 5/8" S.S. Screws

**PRO TIPS**



Start by glazing the 4 corners on the side walls of the greenhouse. This will help to square the frame from front to back. Don't be afraid to shift the Frame as necessary.

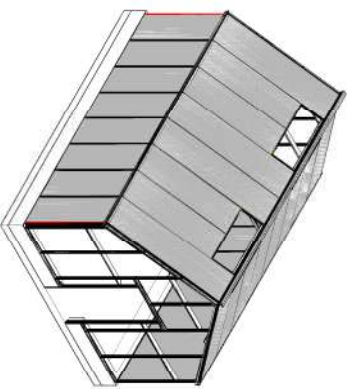

**STAGE 34C: SIDE WALL CORNER CAPS - (6MM SINGLE GLASS)**

**STEPS:**

6. TUCK THE TOP OF THE RIPPED CAP BENEATH THE GUTTER AND INSIDE THE CORNER POST.
7. SECURE THE CAP TO THE GLAZING BAR.

REPEAT FOR ALL CORNERS

CONTINUE ON NEXT PAGE

**\*WARNING\***  
 - DO NOT USE A CORDLESS DRILL DURING THIS STAGE-  
 OVER-TIGHTENING THE SCREWS CAN  
 CAUSE THE GLASS TO SHATTER

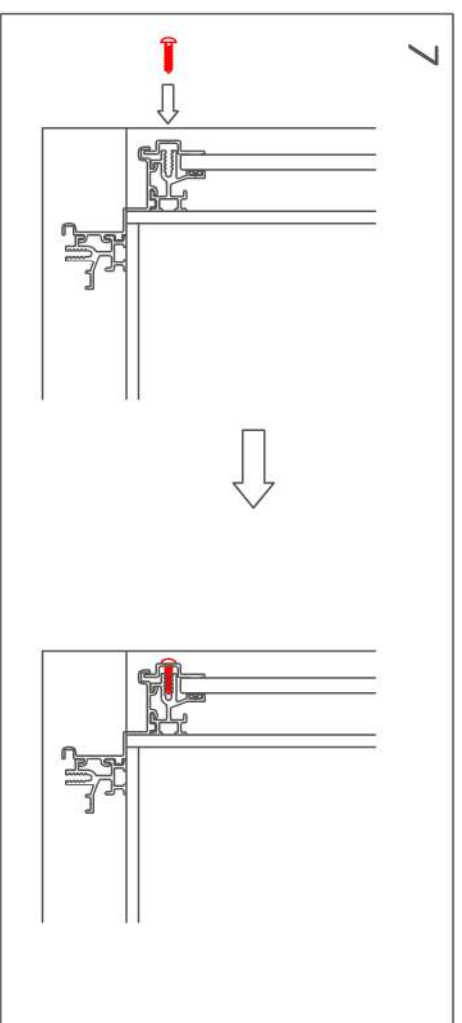
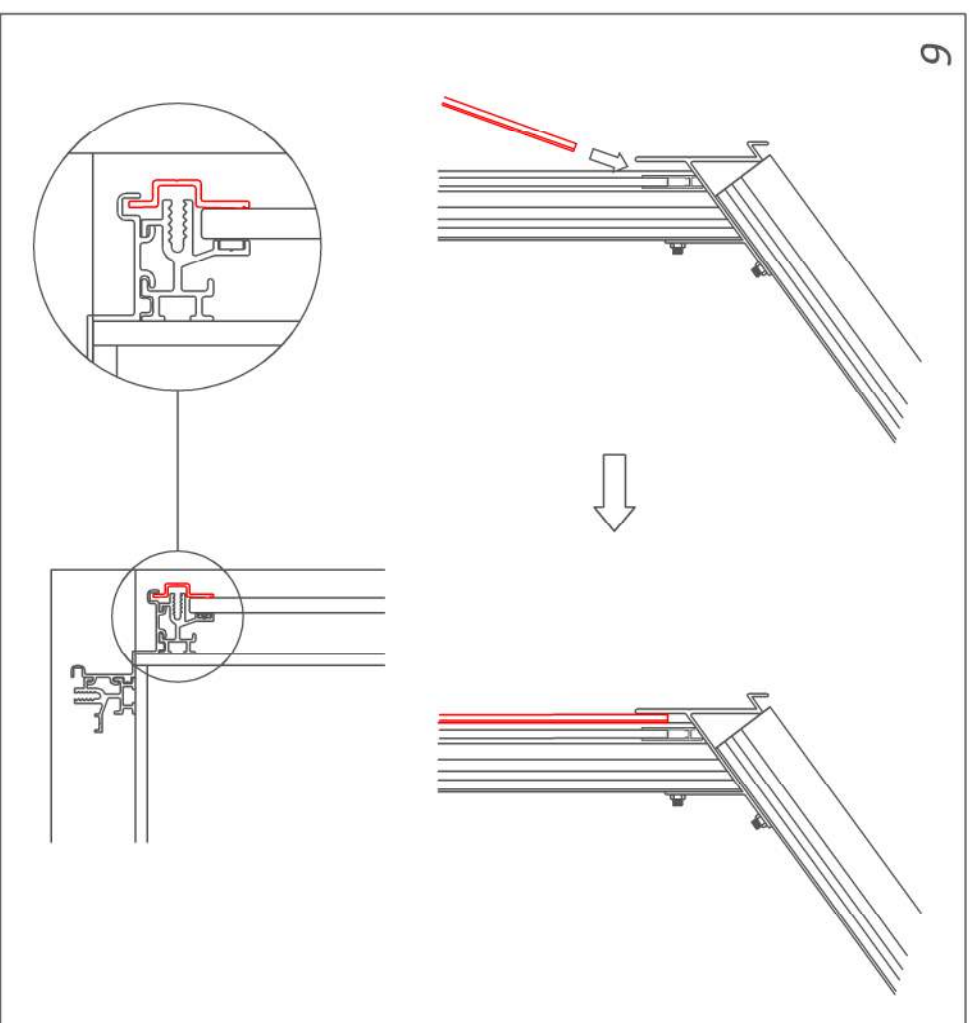
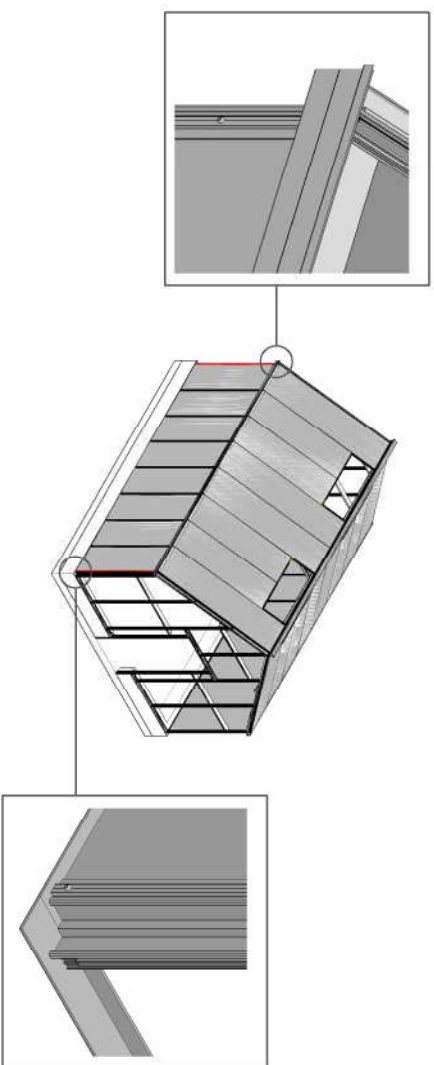

**PRO TIPS**

All Glazing Caps are cut and punched so that the holes will line up horizontally if installed right side up.

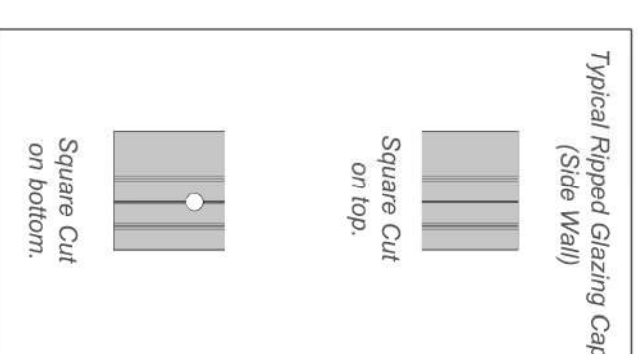

**Parts List:**



Glazing Caps



Ripped Glazing Caps



h-Channels



6mm Single Glass Panels



#8 x 3/8" S.S. Screws

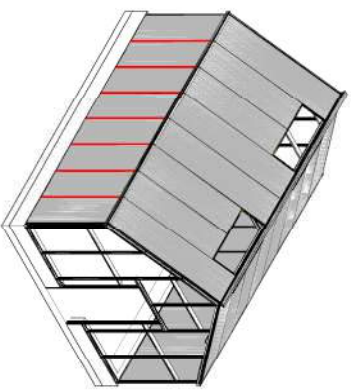

**STAGE 34D: SIDE WALL CAPS -  
(6MM 6MM SINGLE GLASS)**

**STEPS:**

- 8. TUCK THE TOP OF THE CAP BENEATH THE GUTTER.
- 9. SECURE THE CAP TO THE GLAZING BAR.

REPEAT FOR ALL REMAINING CAPS

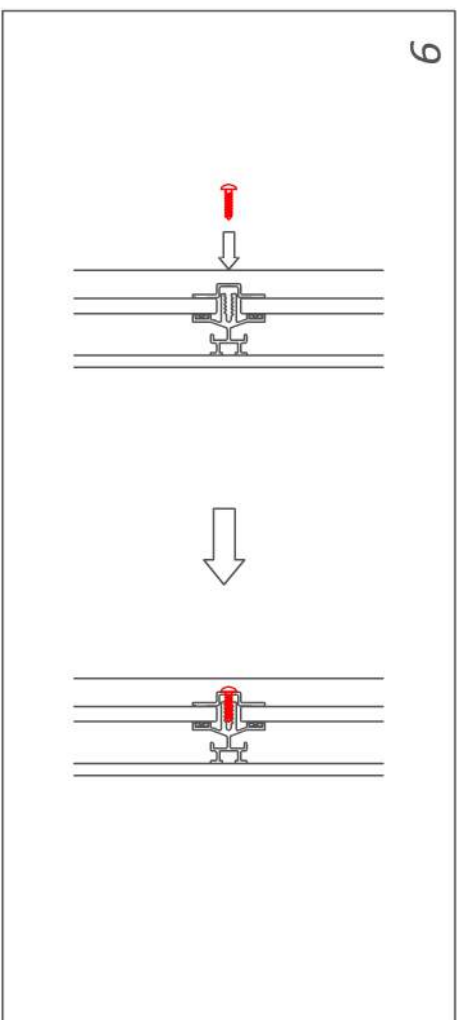
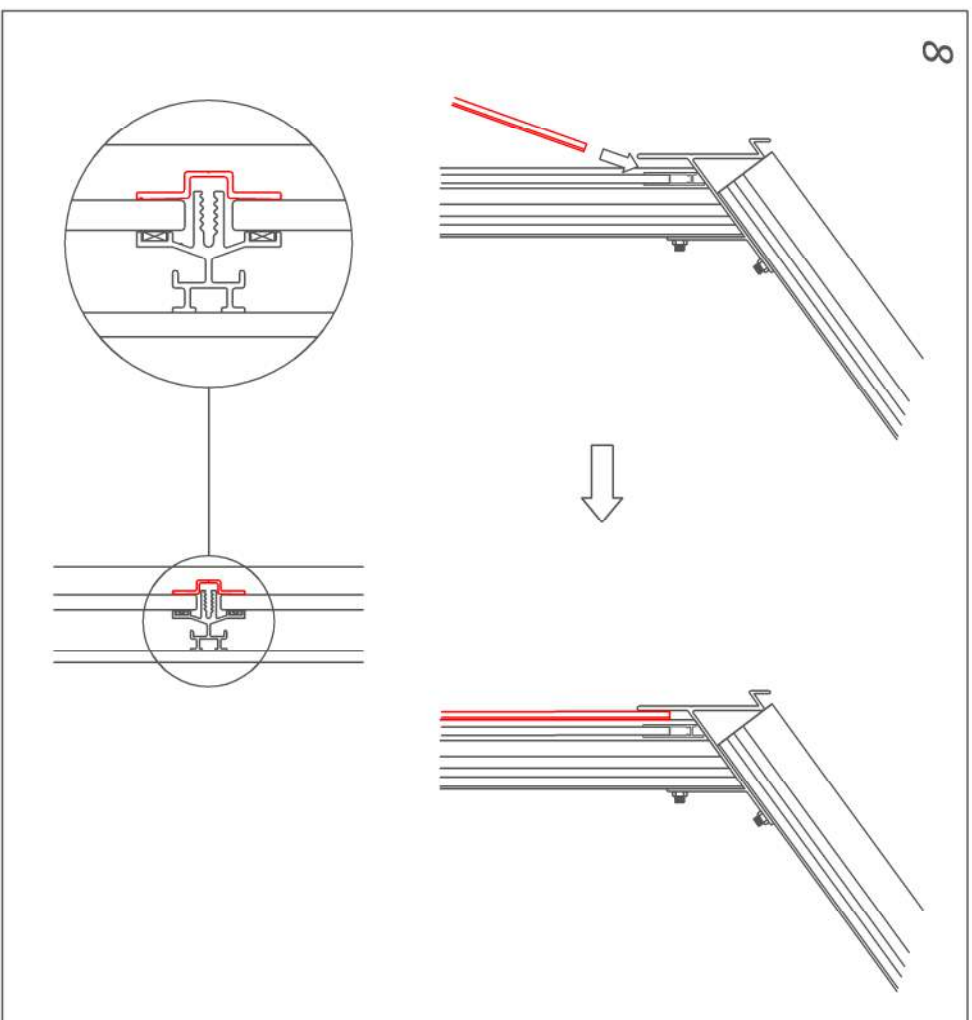
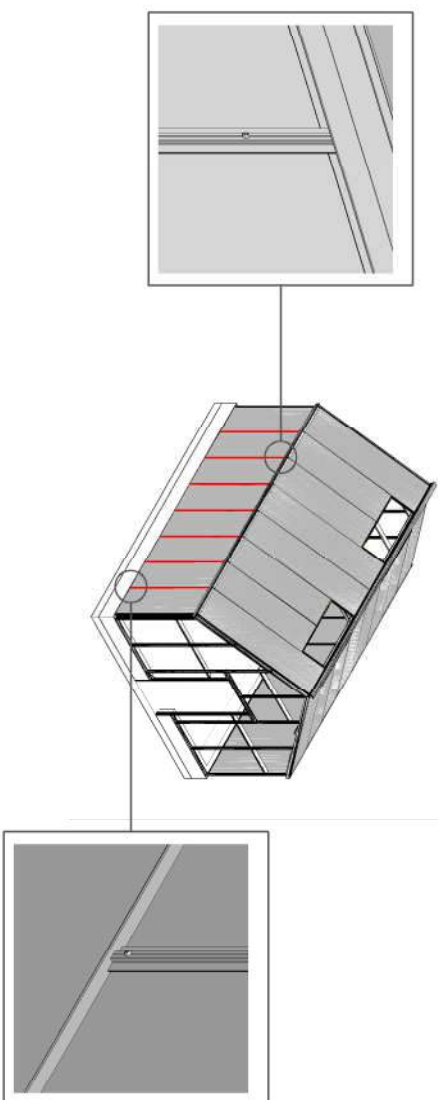

**PRO TIPS**

All Side Wall Caps should sit flush on top of the Base and be tucked underneath the gutter.

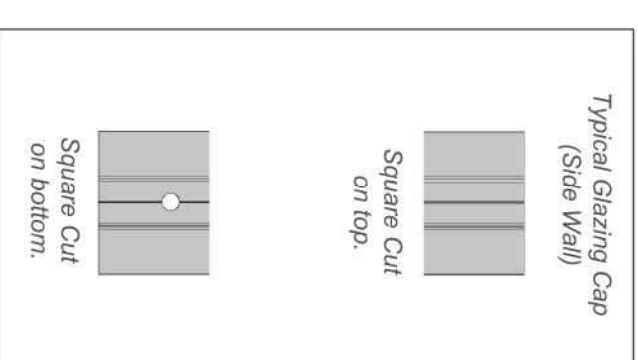

**Parts List:**



Glazing Caps



Ripped Glazing Caps



h-Channels



6mm Single Glass Panels



#8 x 5/8" S.S. Screws



**CROSS COUNTRY GREENHOUSES**

HOBBY AND CUSTOM



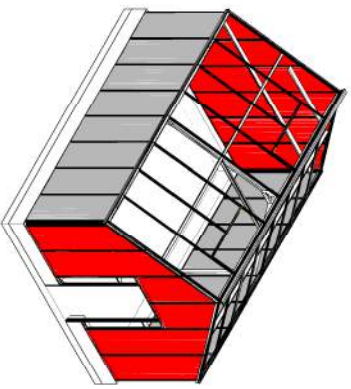

**STAGE 35A: GABLE GLAZING -  
(6MM SINGLE GLASS)**

- STEPS:**
1. PEEL THE BROWN PAPER FROM THE FOAM TAPE ON THE SIDE WALL GLAZING BARS.
  2. PLACE THE H-CHANNEL ON THE TOP OF A GLASS PANEL.
- CONTINUE ON NEXT PAGE

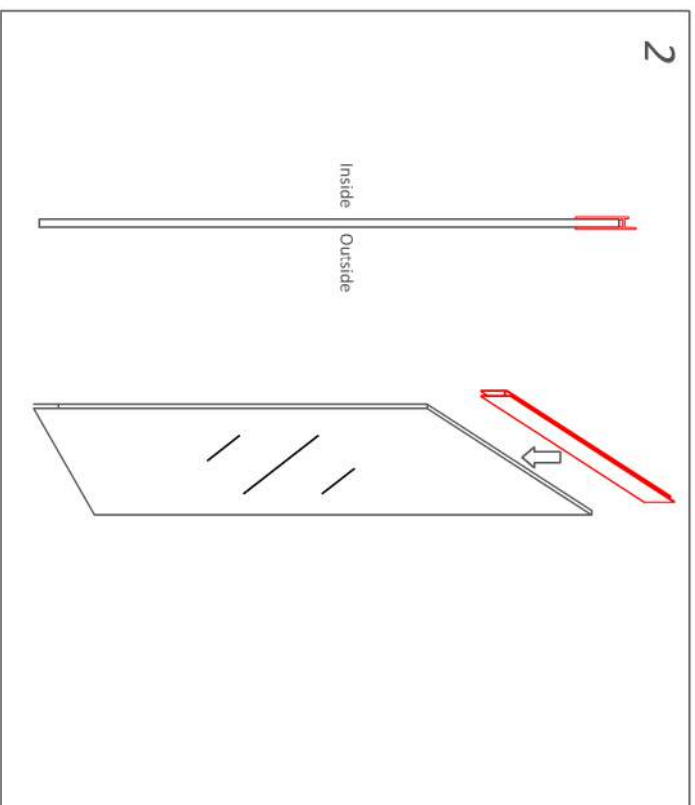
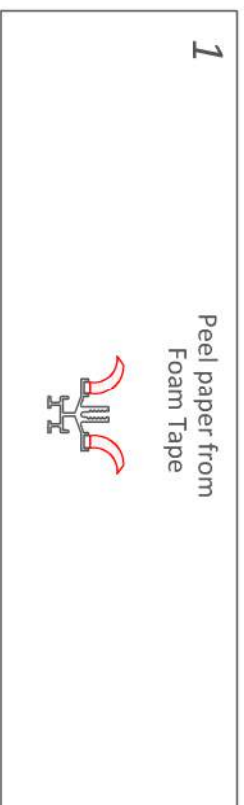
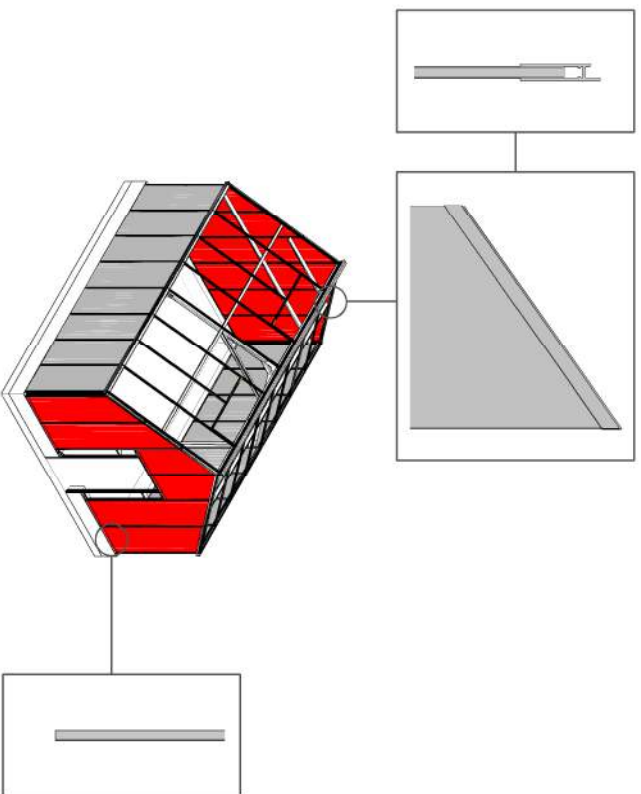

**PRO TIPS**

*h-Channels for the top of the Glass are cut at angle on both ends to match the roof pitch of the greenhouse.*

*Glazing Caps & h-Channels will come packaged specific to their location in the greenhouse. Open the Bundles only as you need them.*

**Parts List:**



Glazing Caps



Glazing Caps (Ripped)



h-Channels



6mm Single Glass Panels



#8 x  $\frac{5}{8}$ " S.S. Screws

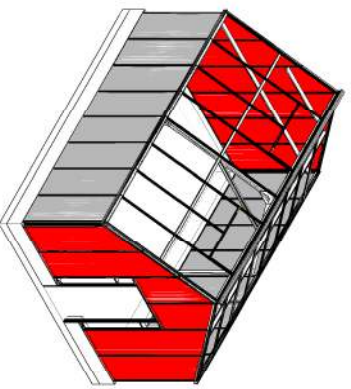

### STAGE 35B: GABLE GLAZING - (6MM SINGLE GLASS)

**STEPS:**

3. SLIP THE TOP OF THE GLASS PANEL BENEATH THE END RAFTER.
  4. PUSH THE BOTTOM OF THE GLASS PANEL INTO POSITION.
  5. PUSH THE TOP H-CHANNEL UP UNTIL IT TOUCHES THE UNDERSIDE OF THE END RAFTER.
- REPEAT FOR ALL ANGLE-CUT GABLE GLAZING
6. FILL GAP BETWEEN THE BASE AND DOOR FRAME WITH CAULKING.
  7. INSERT THE GLASS PANEL INTO THE SIDE OF THE DOOR FRAME AND ROTATE IT INTO POSITION

CONTINUE ON NEXT PAGE

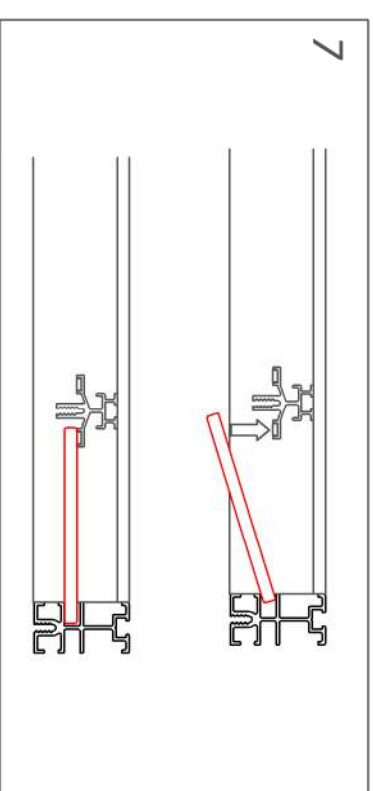
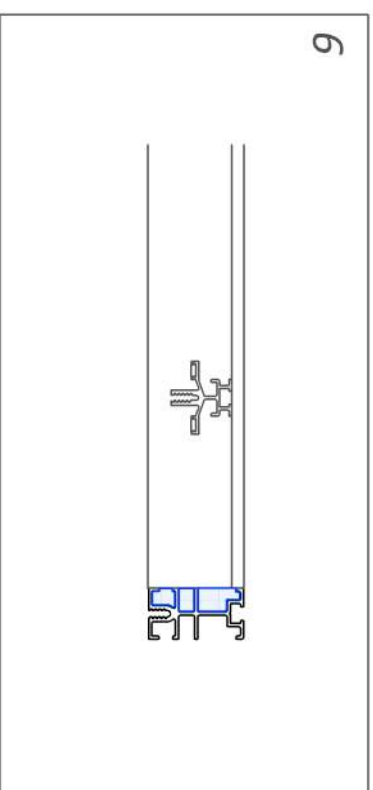
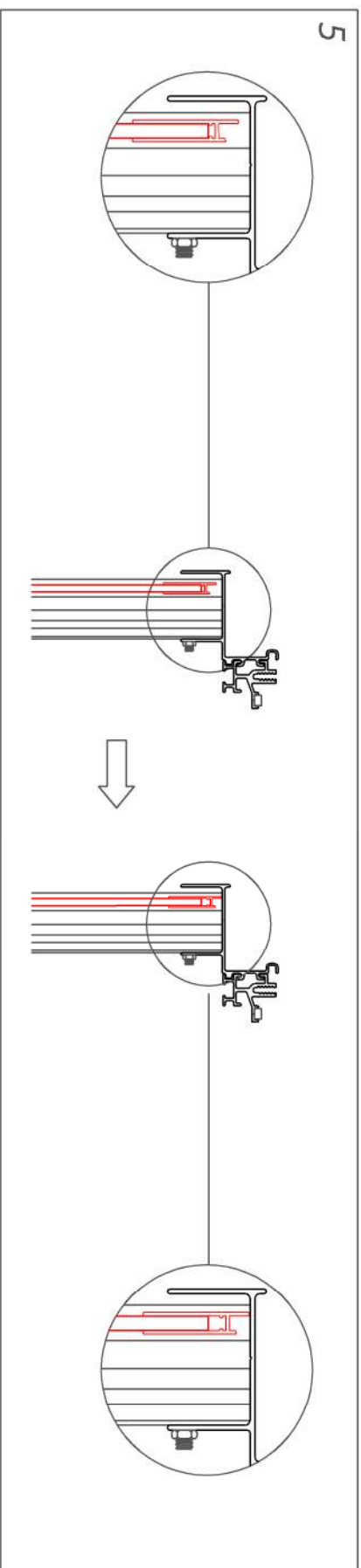
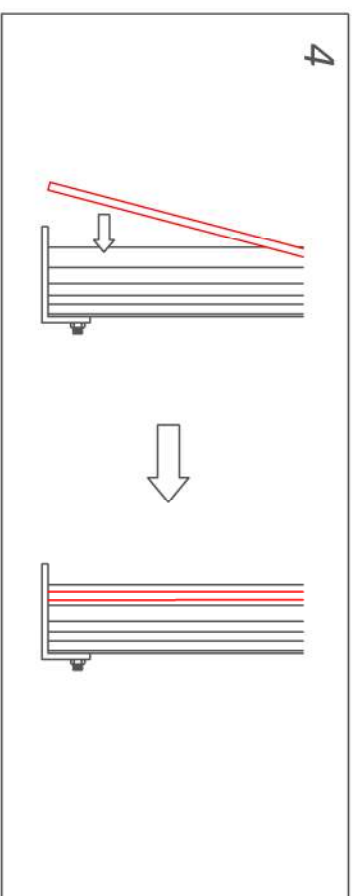
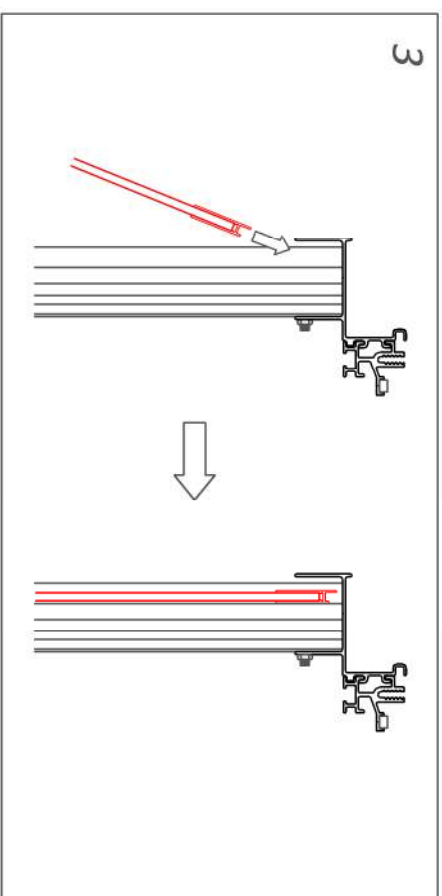
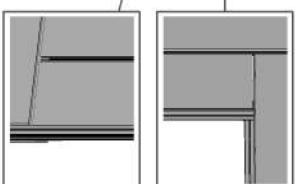
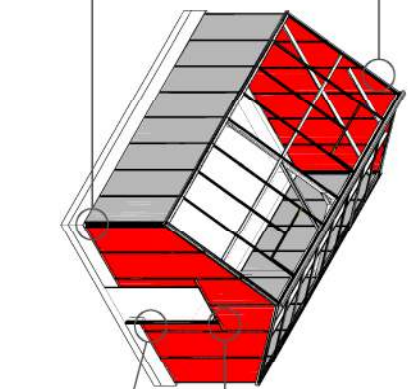
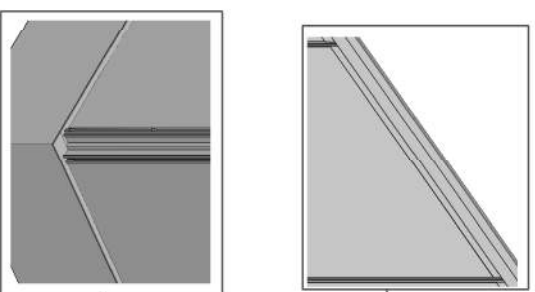

**Parts List:**



Glazing Caps



Glazing Caps (Ripped)



h-Channels



6mm Single Glass Panels



#8 x 5/8" S.S. Screws



Caulking

**PRO TIPS**



Start by glazing the 4 corners on the gable walls of the greenhouse. This will help to square the frame from left to right. Don't be afraid to shift the Frame as necessary.

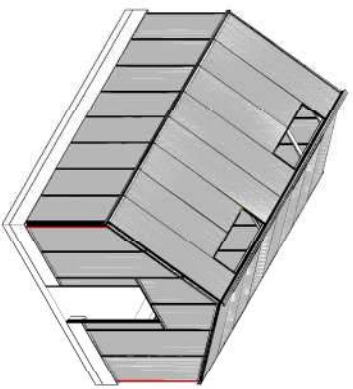

### STAGE 35C: GABLE CORNER CAPS - (6MM SINGLE GLASS)

**STEPS:**

- 8. TUCK THE TOP OF THE RIPPED CAP BENEATH THE END RAFTER AND INSIDE THE CORNER POST.
- 9. SECURE THE CAP TO THE GLAZING BAR.

REPEAT FOR ALL CORNERS

CONTINUE ON NEXT PAGE

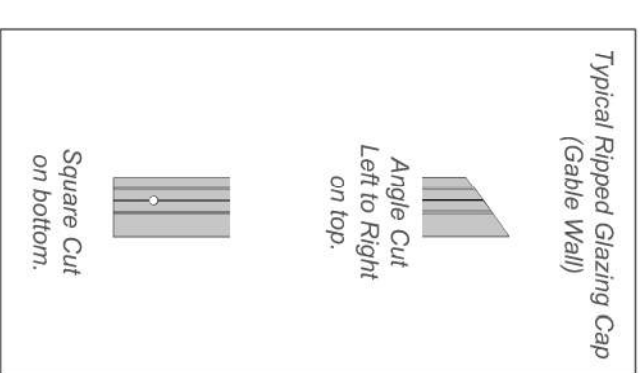
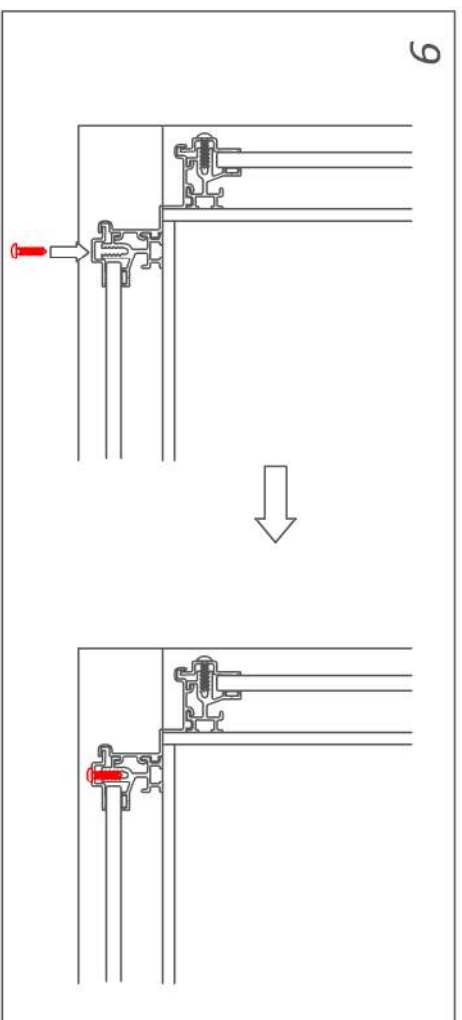
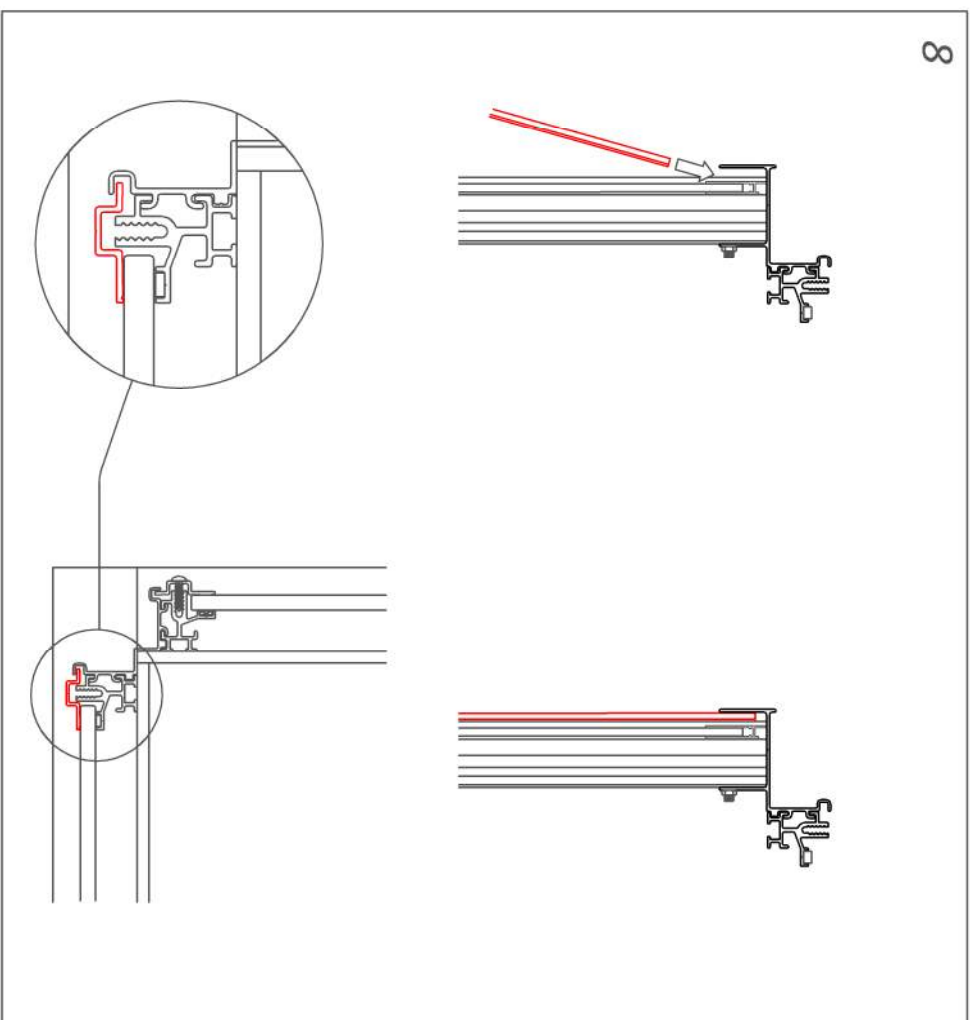
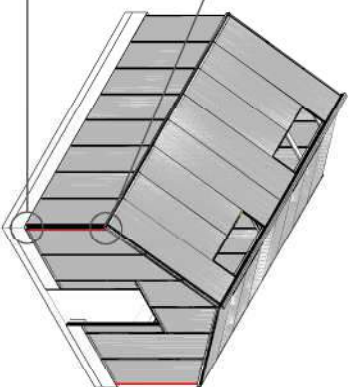
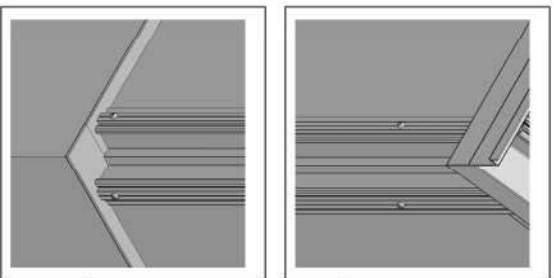

**Parts List:**



Glazing Caps



Glazing Caps (Ripped)



h-Channels



6mm Single Glass Panels



#8 x 5/8" S.S. Screws

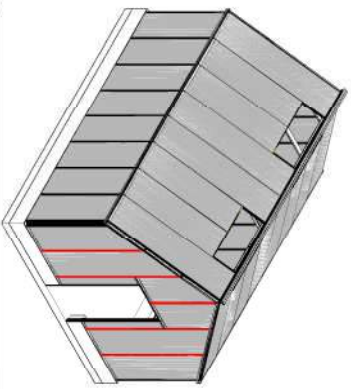

**STAGE 35D: GABLE CAPS -  
(6MM SINGLE GLASS)**

STEPS:

- 10. TUCK THE TOP OF THE CAP BENEATH THE END RAFTER.
  - 11. SECURE THE CAP TO THE GLAZING BAR.
- REPEAT FOR ALL REMAINING CAPS

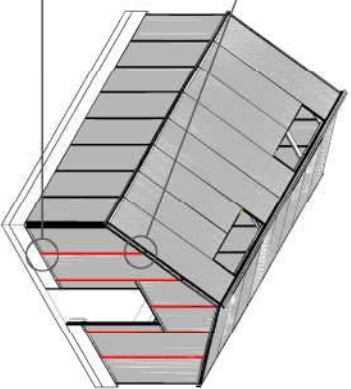
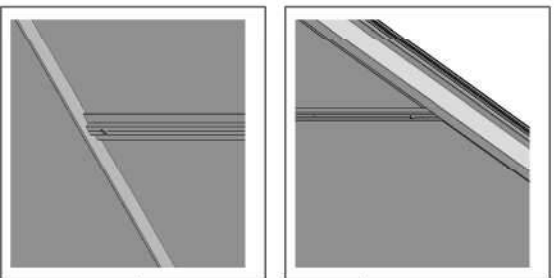

Parts List:



Glazing Caps



Glazing Caps (Ripped)



h-Channels



Twinwall Polycarbonate Panels



#8 x 5/8" S.S. Screws

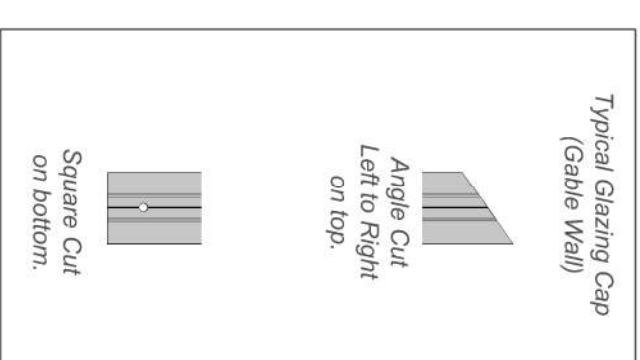
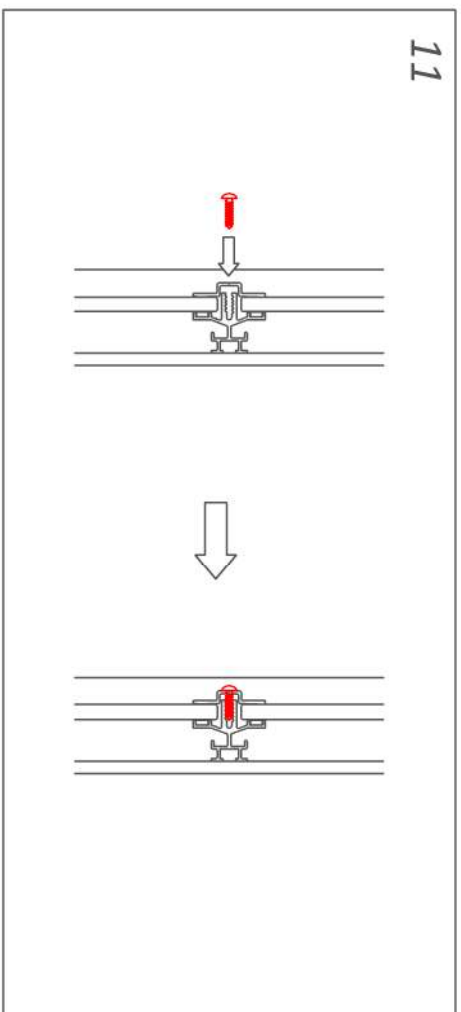
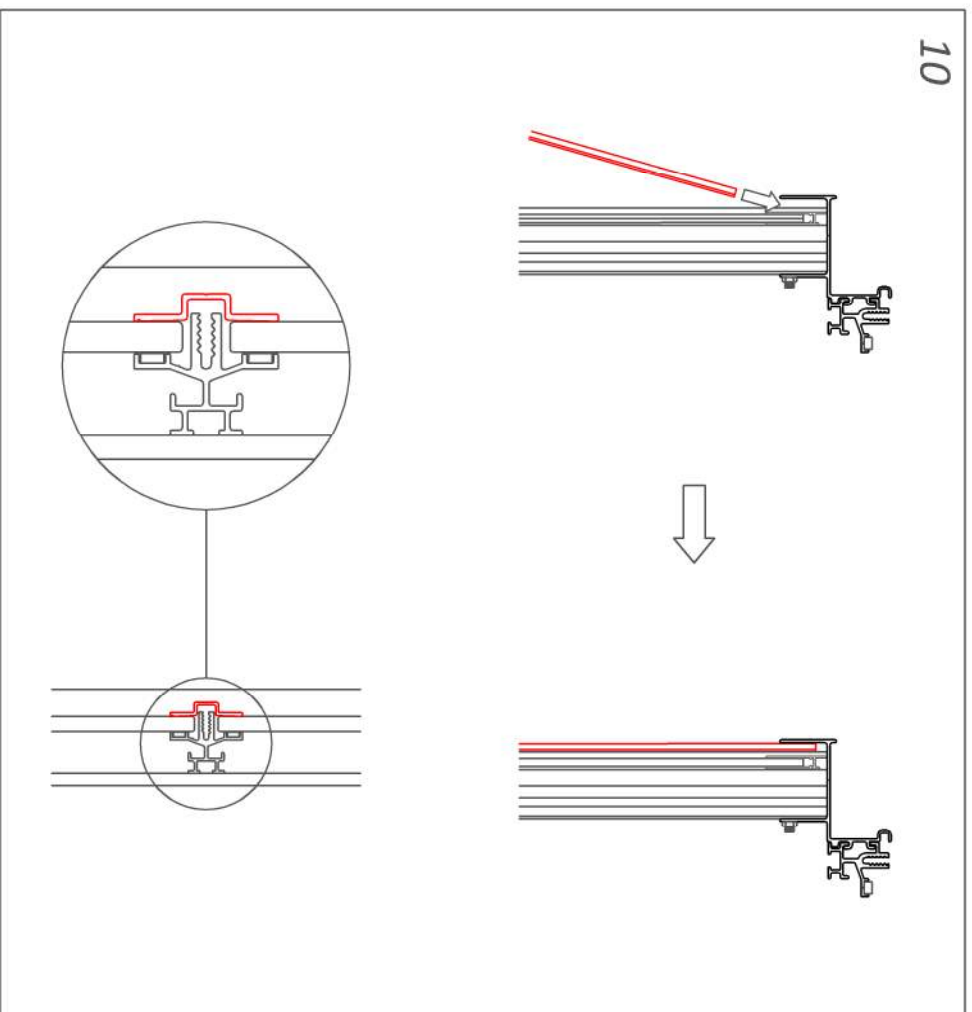

# STAGE 36: SEALING - (6MM SINGLE GLASS)

- CLEAR SILICONE (PROGLAZE)
- COLORED CAULKING (TREMCO 830)

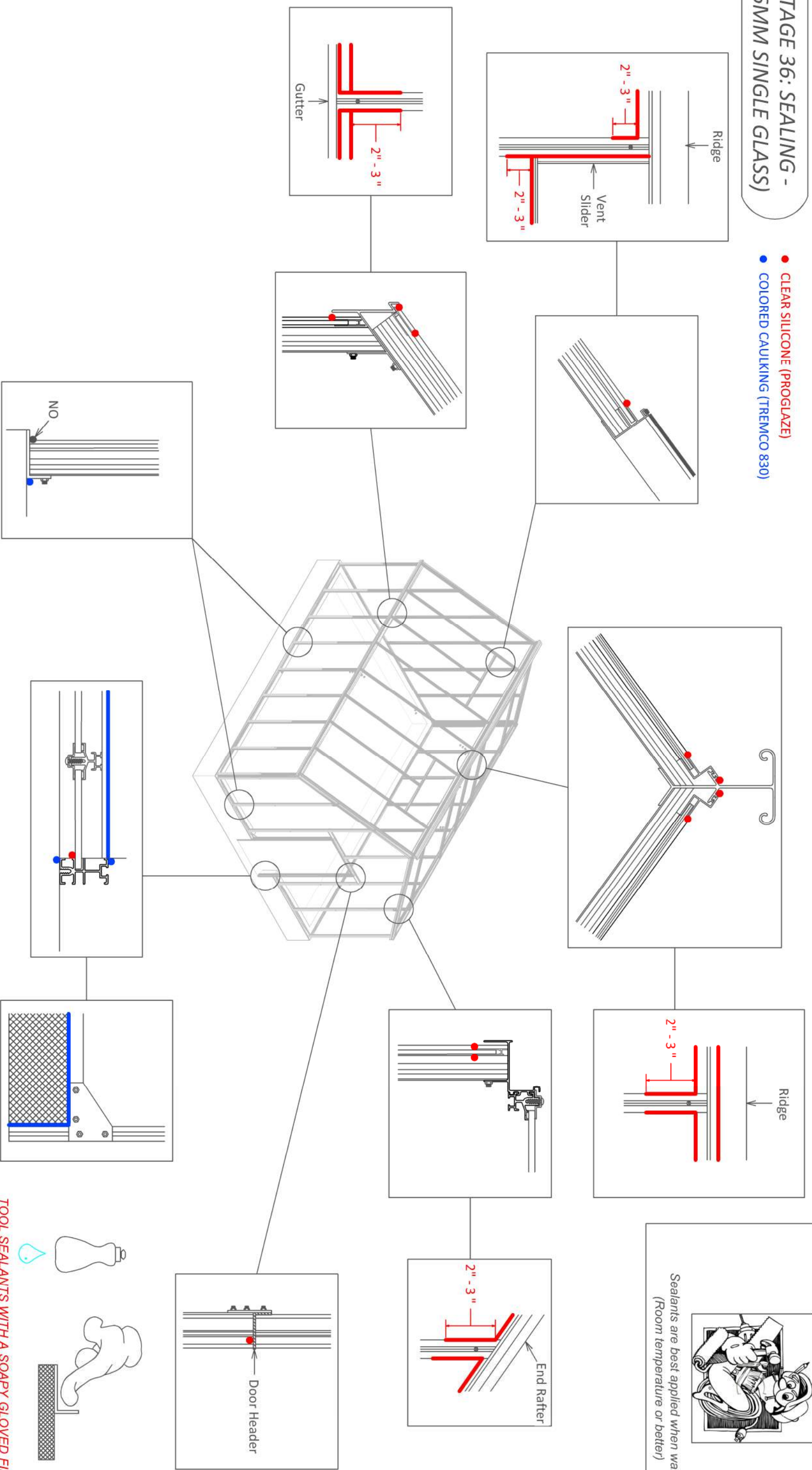

## PRO TIPS

Sealants are best applied when warm (Room temperature or better)

TOOL SEALANTS WITH A SOAPY GLOVED FINGER OR A CAULK-SMOOTHING TOOL.

### Parts List:

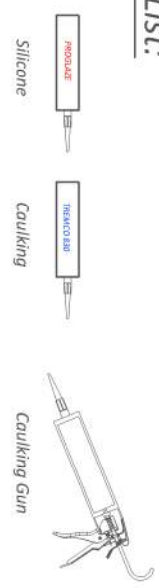

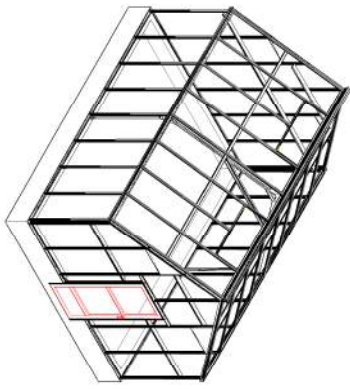

**STAGE 37: STORM DOOR - SINGLE  
(ALL GLAZING TYPES)**

**STEPS:**

1. FIT THE STORM DOOR WITHIN THE DOOR FRAME.
2. RAISE THE DOOR AS HIGH AS IT WILL GO WITHIN THE DOOR FRAME & INSTALL THE UPPERMOST #10 X ½" SCREWS IN THE TOP CORNERS.
3. INSTALL REMAINING SCREWS ON HINGE SIDE.
4. REMOVE PLASTIC CLIPS FROM THE NON-HINGE SIDE OF THE DOOR.
5. INSTALL #10 X ½" SCREWS ON NON-HINGE SIDE OF THE DOOR.
6. INSTALL #10 X ½" SCREWS ACROSS THE TOP OF THE DOOR.
7. CONNECT PLATE TO CLEAT WITH #8 X ½" SELF TAPPING SCREWS.
8. ATTACH CLEAT ASSEMBLY TO DOOR FRAME WITH ¼" X ½" BOLTS & NUTS.

INSTALL THE DOOR HANDLE AS PER THE MANUFACTURERS INSTRUCTIONS LOCATED IN THE BROWN CARDBOARD BOX CONTAINING THE HANDLE.

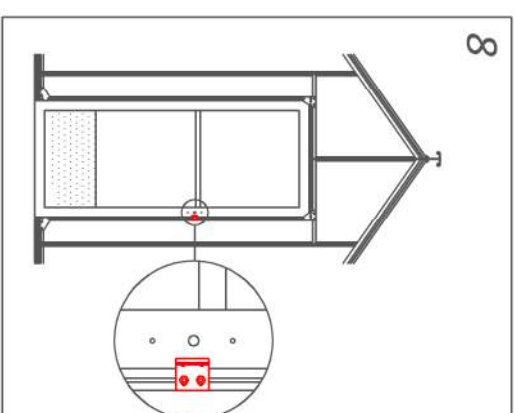
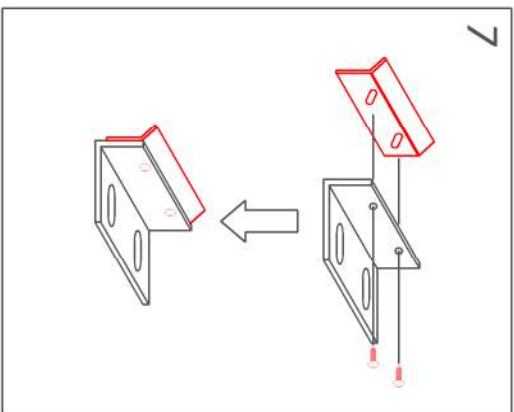
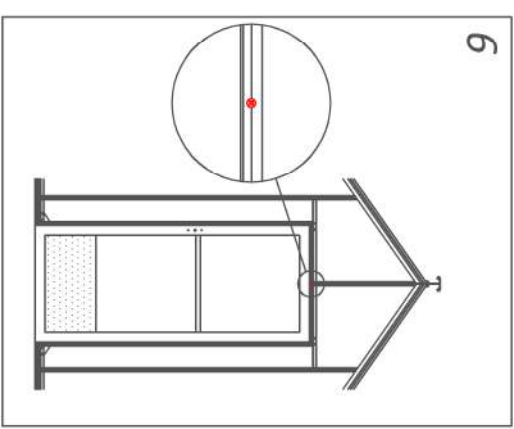
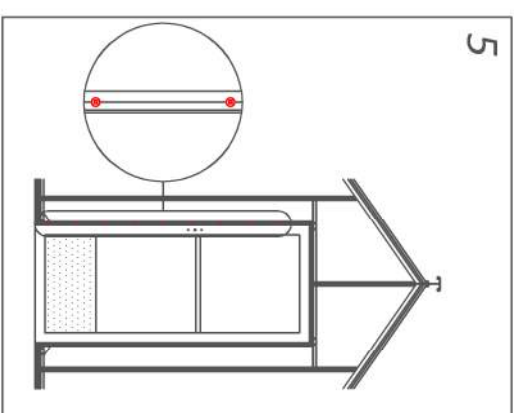
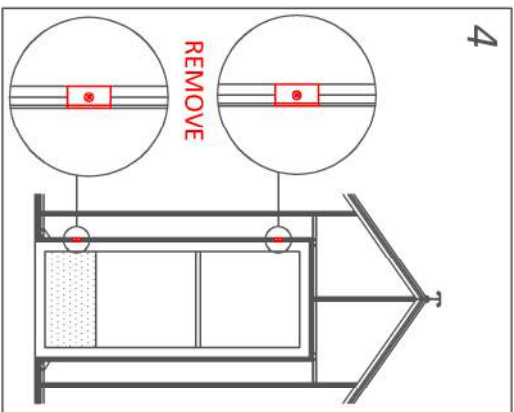
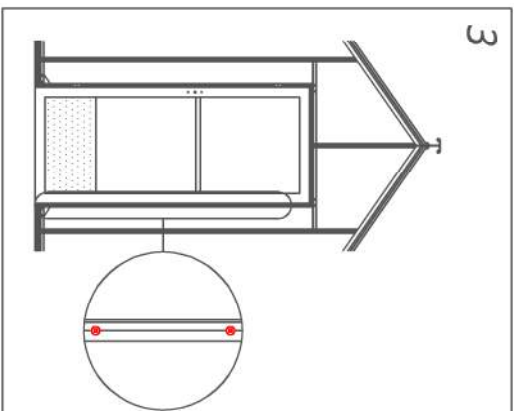
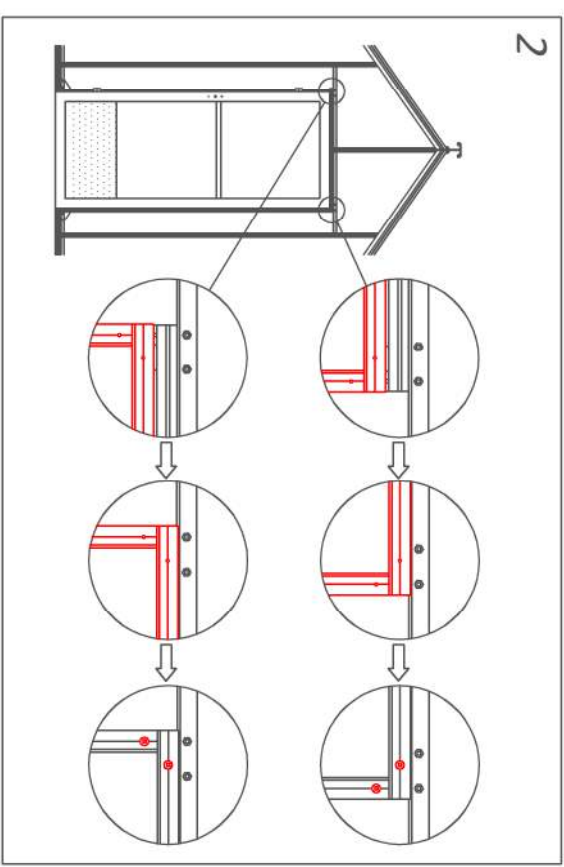
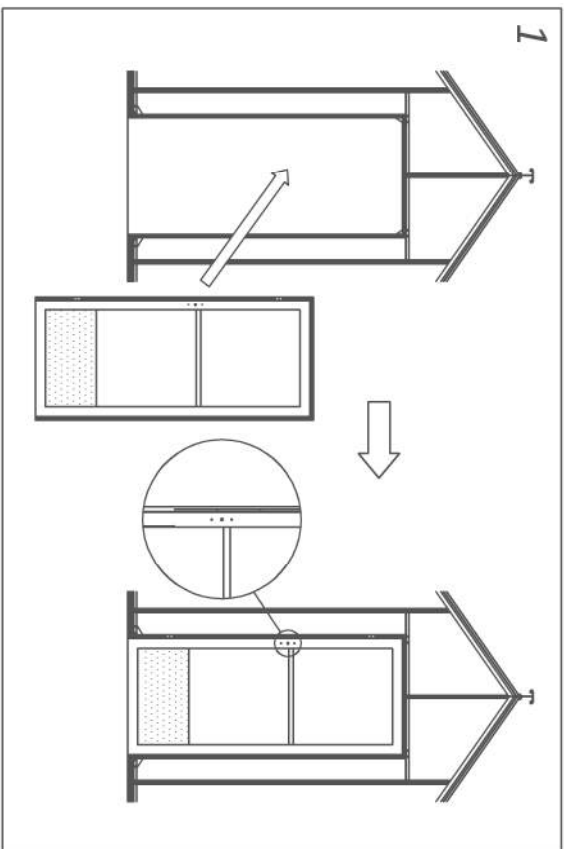

**Parts List:**

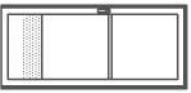

Single Storm Door



#10 x ½" S.S. Screws



¼" x ½" S.S. Bolt & Nut



#8 x ½" Self-Tapping Screws



Cleat



Plate

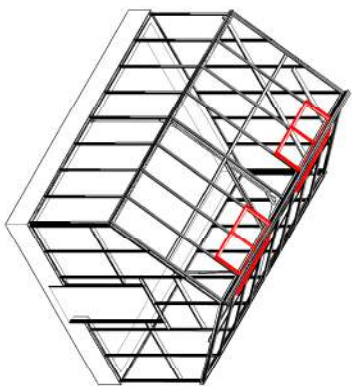

### ACCESSORIES: ROOF VENT INSTALLATION (ALL GLAZING TYPES)

- STEPS:**
1. REMOVE PRE-INSTALLED SCREWS FROM RIDGE.
  2. SLIDE ROOF VENT(S) DOWN THE LENGTH OF THE RIDGE & INTO POSITION ABOVE THE ROOF VENT SLIDERS.
  3. REPLACE SCREWS REMOVED IN STEP 1.
- ATTACH VENT OPENERS AS PER MANUFACTURERS INSTRUCTIONS.

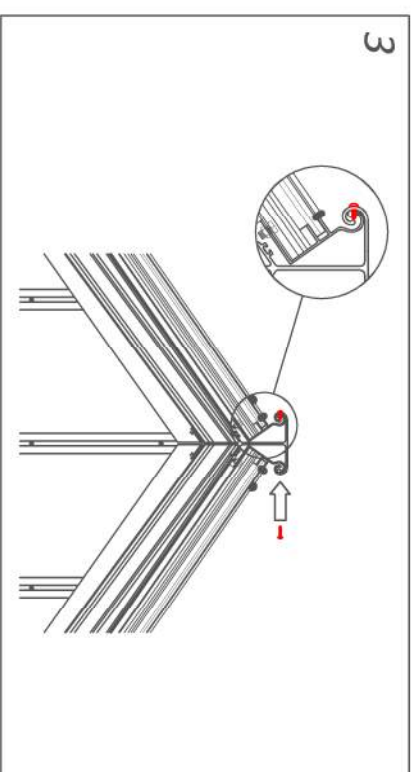
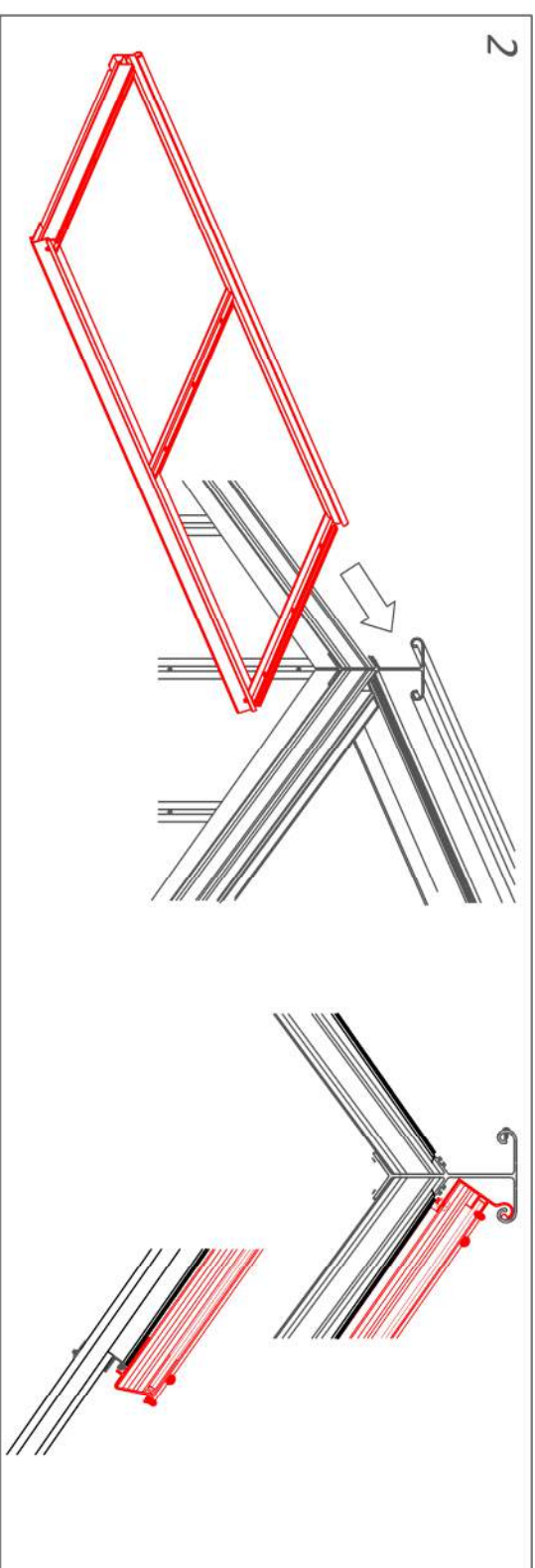
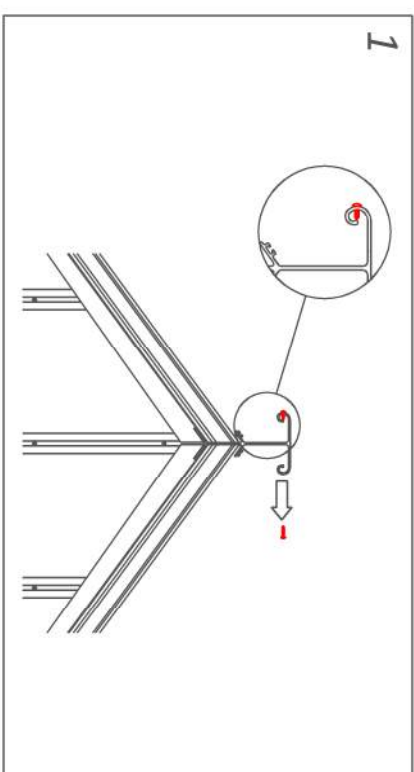

Roof Vents must be slid in from the end of the Ridge in order for them to fit properly once installed.



#### PRO TIPS

#### Parts List:



Roof Vent(s) - Fully Assembled

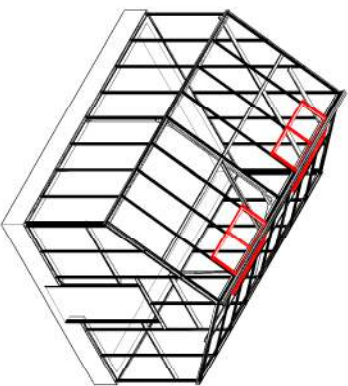

**ACCESSORIES: ROOF VENT ASSEMBLY  
(6MM TWINWALL POLYCARBONATE)**

- STEPS:**
1. APPLY FOAM TAPE TO ALL GLAZING BARS.
  2. INSERT (2)  $\frac{1}{4}$ " x  $\frac{3}{8}$ " BOLTS INTO EACH GLAZING BAR
  3. SECURE GLAZING BARS TO VENT HINGE & VENT GUTTER.
  4. PEEL THE BROWN PAPER FROM THE FOAM TAPE ON THE GLAZING BARS.
  5. MARK ONE OUTSIDE CORNER OF THE POLYCARBONATE PANELS WITH A FELT PEN.
  6. PEEL THE FILM OFF BOTH SIDES OF THE POLYCARBONATE PANEL.

CONTINUE ON NEXT PAGE

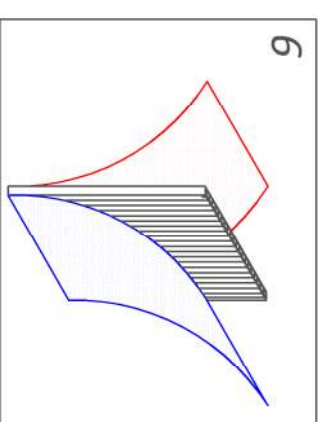
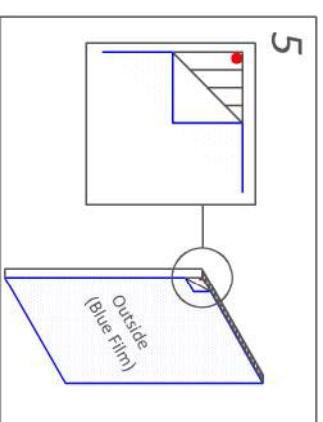
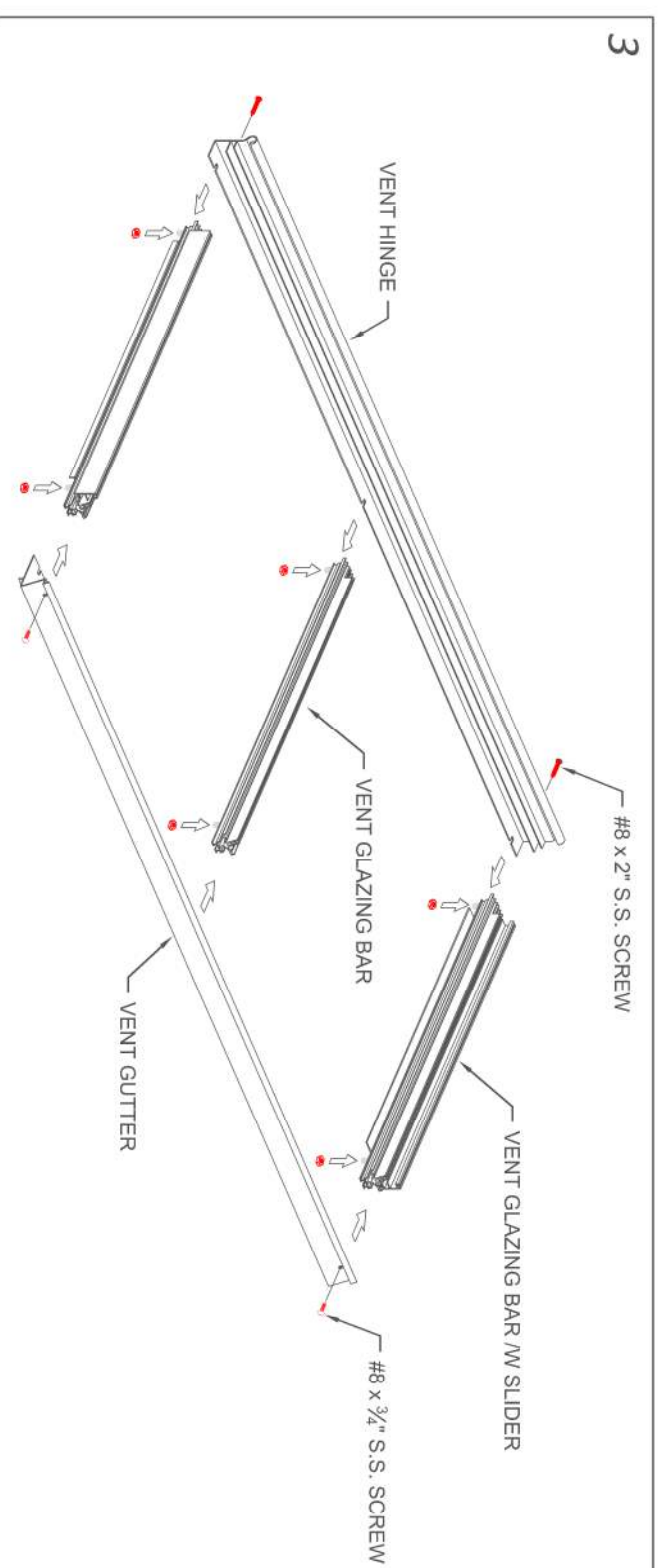
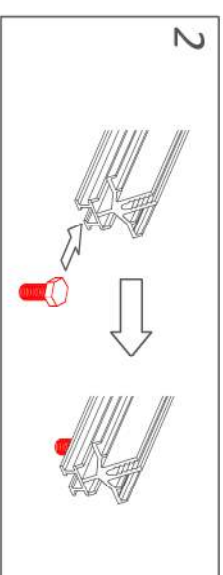
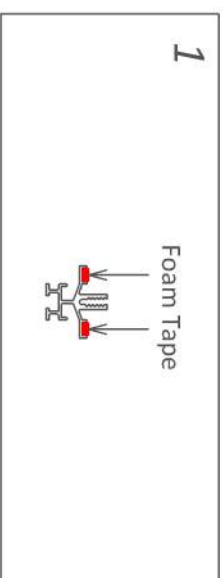

**Parts List:**

\*Note: Do NOT Remove the sliders from glazing bar

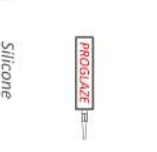
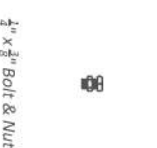
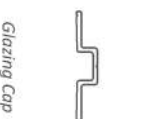
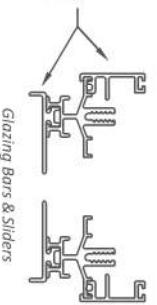



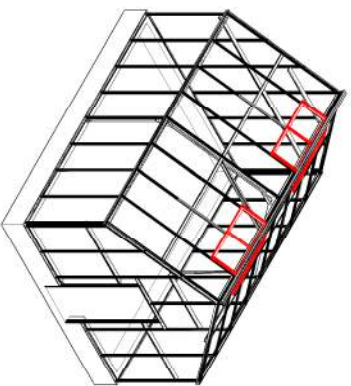

**ACCESSORIES: ROOF VENT  
(6MM TWINWALL POLYCARBONATE)**

- STEPS:**
7. PLACE AN H-CHANNEL ONTO THE BOTTOM END OF EACH POLYCARBONATE PANEL.
  8. INSERT THE POLYCARBONATE PANEL INTO THE VENT HINGE AND PRESS THE H-CHANNEL INTO THE VENT GUTTER.
  9. SECURE THE GLAZING CAPS TO THE GLAZING BARS.
  10. SEAL THE ROOF VENT WITH SILICONE.

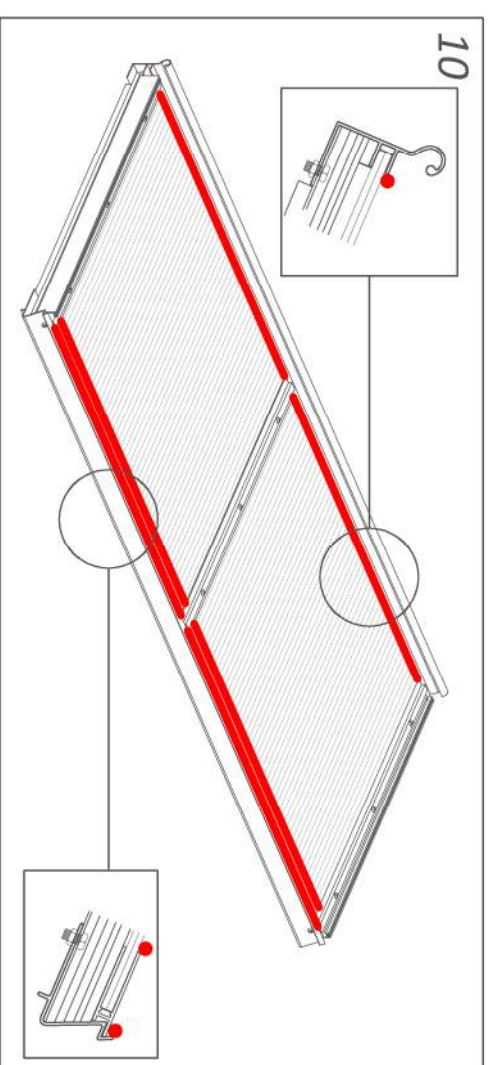
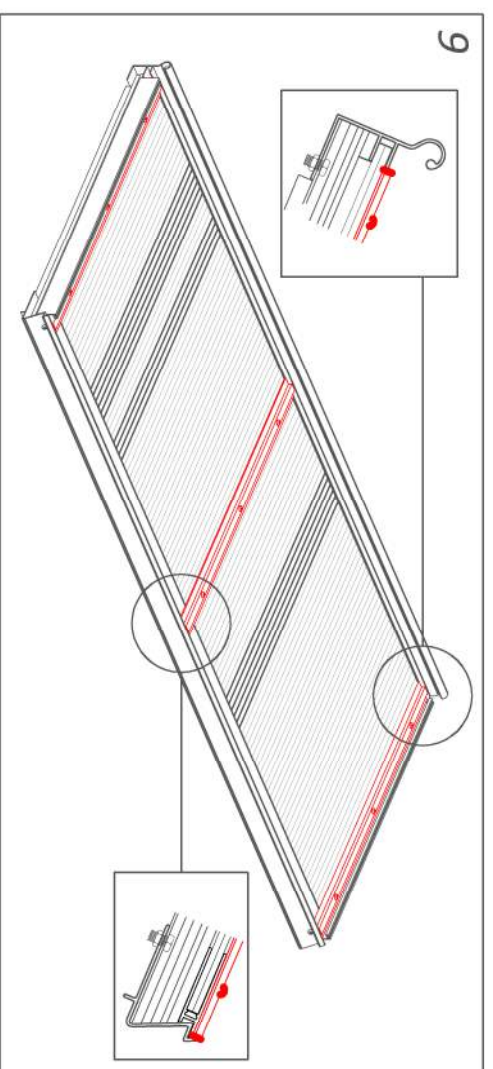
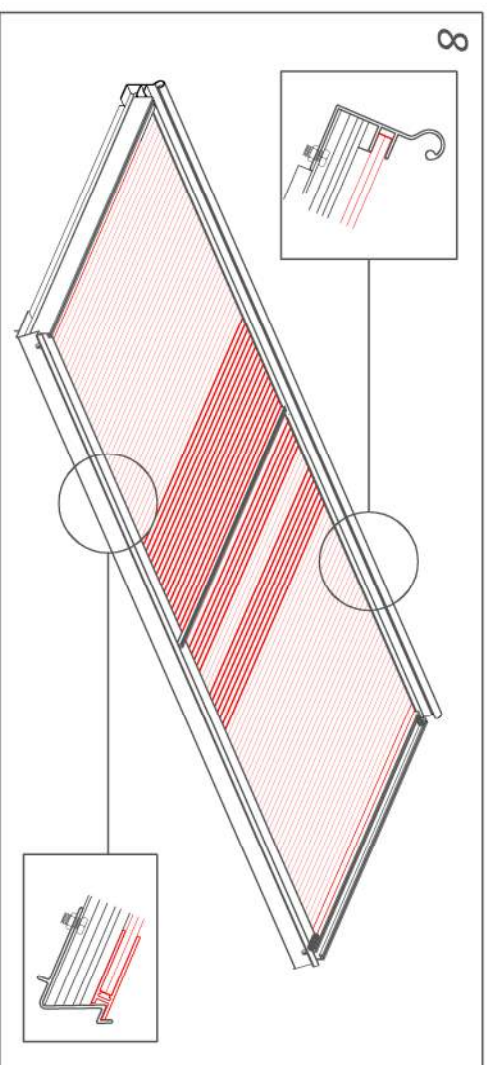
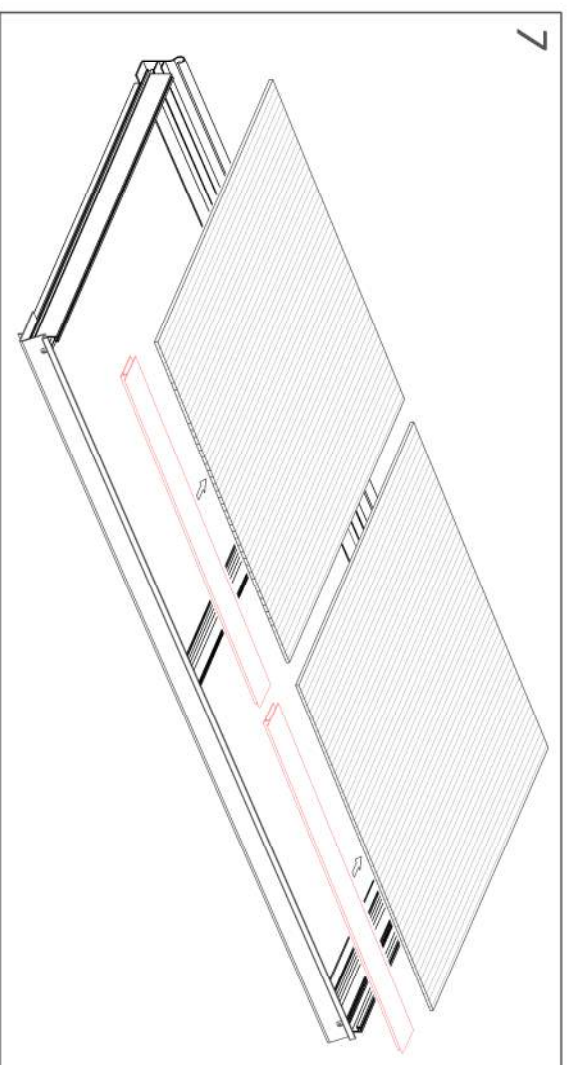

**Parts List:**

- \*Note: Do NOT Remove the sliders from glazing bar
-   
 Glazing Bars & Sliders
  -   
 Vent Gutter
  -   
 Glazing Bar
  -   
 Glazing Cap
  -   
 Vent Hinge
  -   
 h-Channels
  -   
 1/4" x 3/8" Bolt & Nut
  -   
 8 x 2" S.S. Screws
  -   
 8 x 3/4" S.S. Screws
  -   
 8 x 5/8" S.S. Screws
  -   
 10 x 1/2" S.S. Screws
  -   
 Silicone
  -   
 Foam Tape

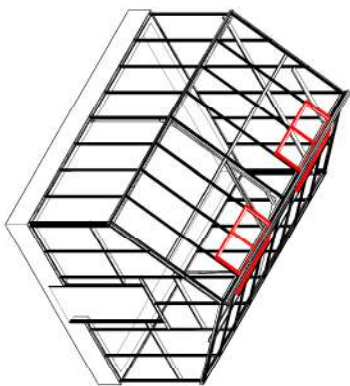

**ACCESSORIES: ROOF VENT ASSEMBLY  
(16MM SMALL POLYCARBONATE)**

**STEPS:**

**REFER TO STAGE 19 FOR FOIL TAPE APPLICATION**

1. APPLY FOAM TAPE TO ALL GLAZING BARS.
2. INSERT (2)  $\frac{1}{4}$ " x  $\frac{3}{8}$ " BOLTS INTO EACH GLAZING BAR
3. SECURE GLAZING BARS TO VENT HINGE & VENT GUTTER.
4. PEEL THE BROWN PAPER FROM THE FOAM TAPE ON THE ROOFL GLAZING BARS.
5. PEEL THE FILM OFF BOTH SIDES OF THE POLYCARBONATE PANEL.
6. ATTACH H-CHANNELS & SETTING BLOCKS.

CONTINUE ON NEXT PAGE

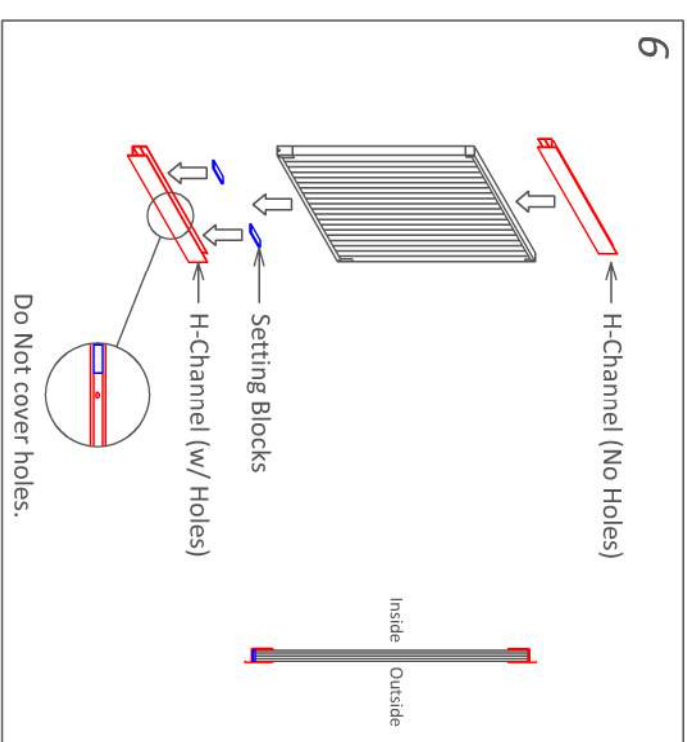
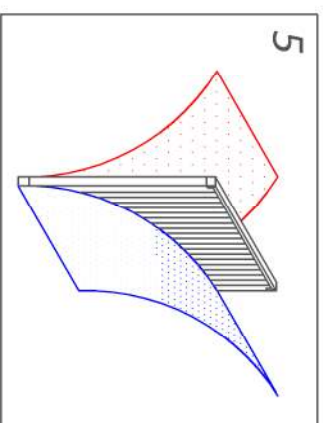
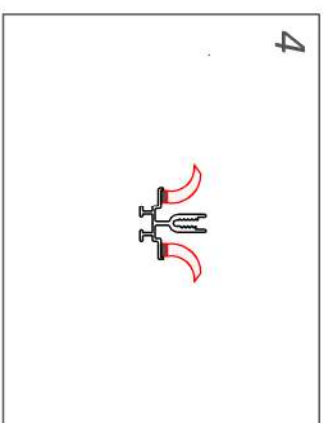
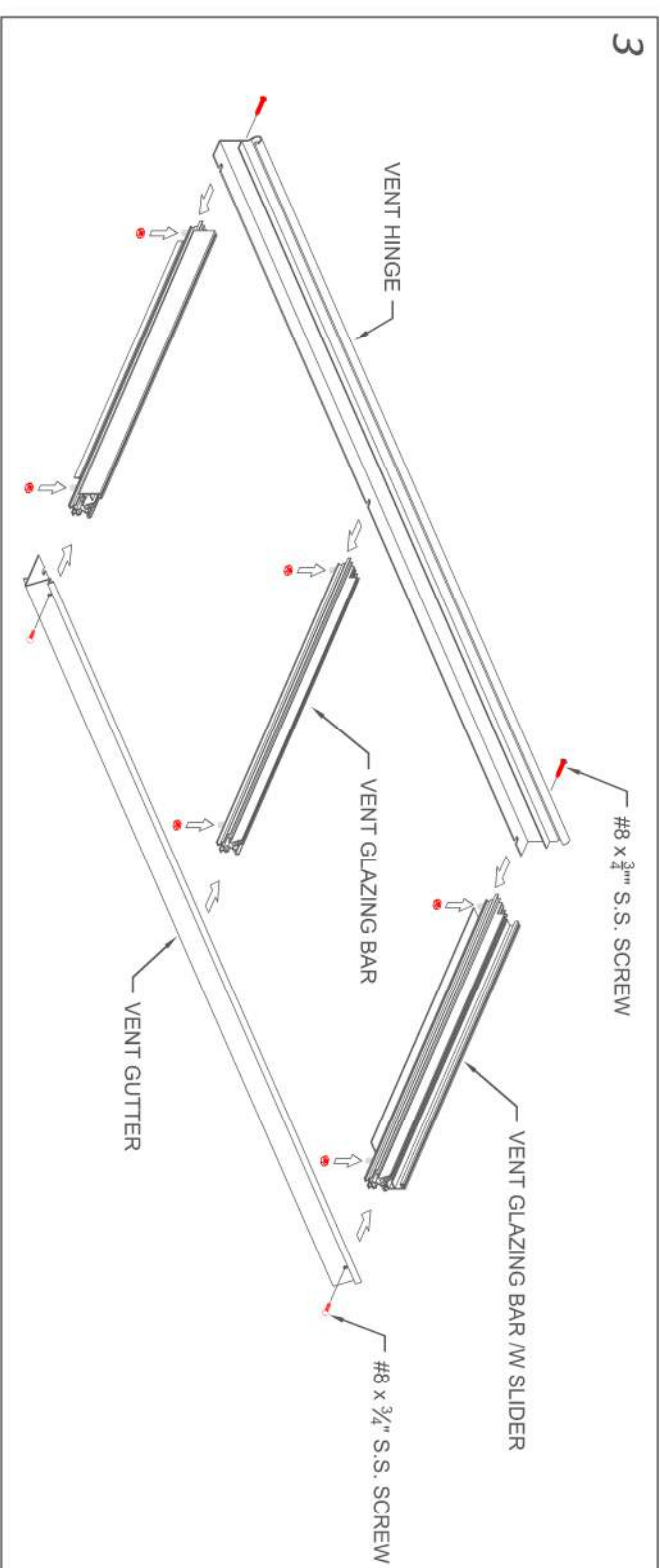
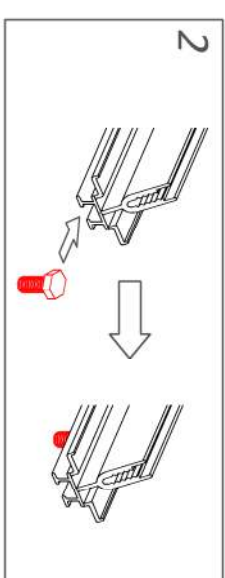
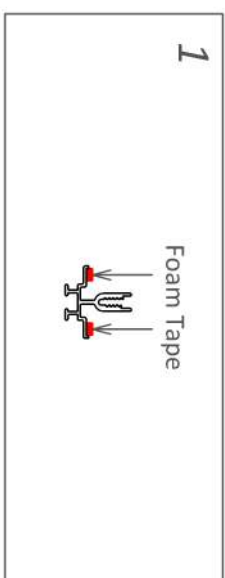

**Parts List:**

\*Note: Do NOT Remove the sliders from glazing bar

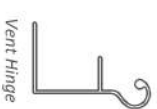
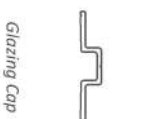
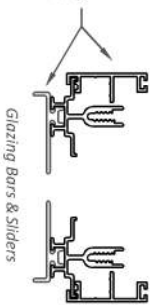

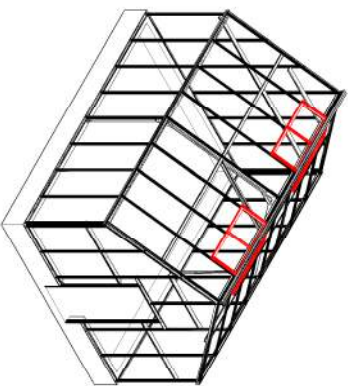

**ACCESSORIES: ROOF VENT ASSEMBLY  
(16MM SMALL POLYCARBONATE)**

**STEPS:**

7. INSERT THE POLYCARBONATE PANEL INTO THE VENT HINGE AND PRESS THE H-CHANNEL INTO THE VENT GUTTER.
8. SECURE THE GLAZING CAPS TO THE GLAZING BARS.
9. SEAL THE ROOF VENT WITH SILICONE.

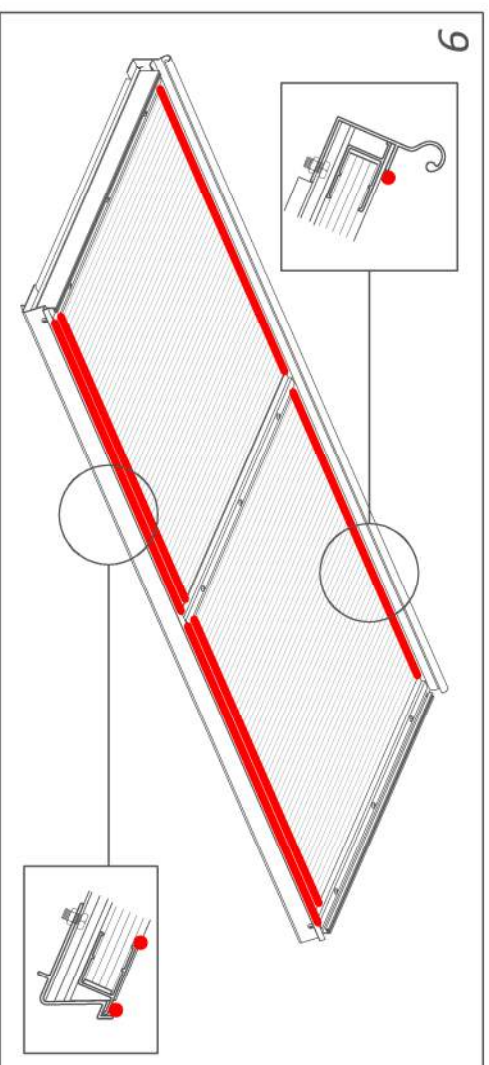
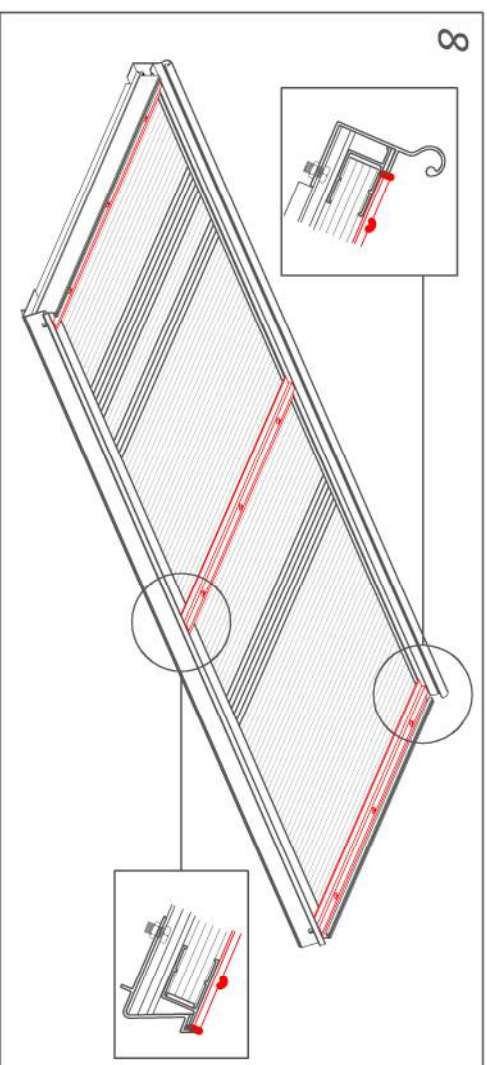
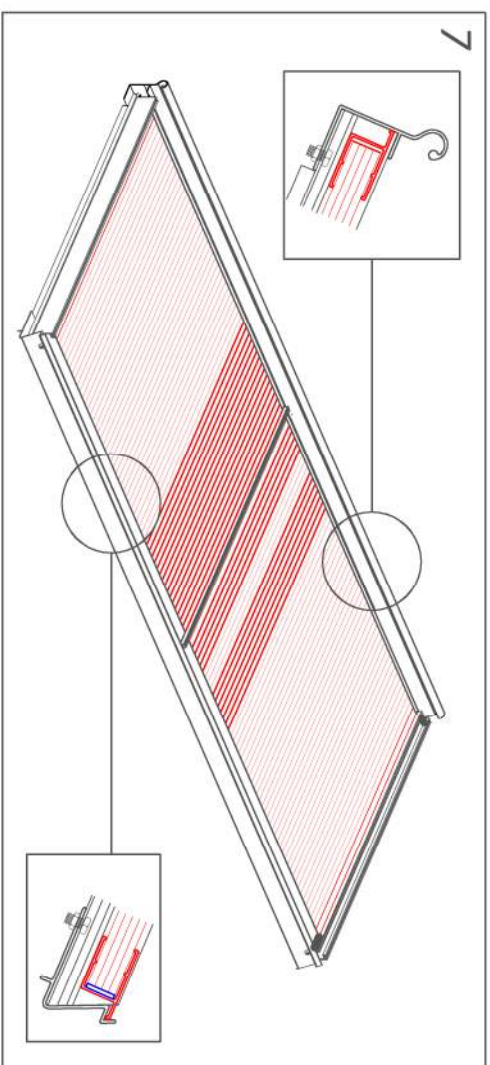

**Parts List:**

\*Note: Do NOT Remove the sliders from glazing bar

- |                        |             |             |             |            |            |               |                        |                       |                        |          |           |  |
|------------------------|-------------|-------------|-------------|------------|------------|---------------|------------------------|-----------------------|------------------------|----------|-----------|--|
|                        |             |             |             |            |            |               |                        |                       |                        |          |           |  |
| Glazing Bars & Sliders | Vent Gutter | Glazing Bar | Glazing Cap | Vent Hinge | H-Channels | Setting Block | 3/4" x 3/8" Bolt & Nut | #8 x 3/4" S.S. Screws | #10 x 3/4" S.S. Screws | Silicone | Foam Tape |  |

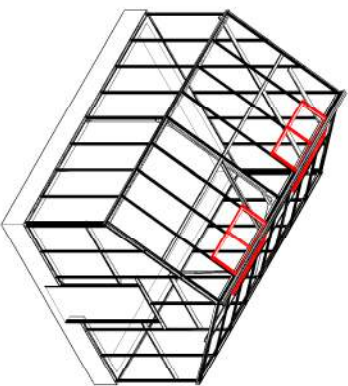

**ACCESSORIES: ROOF VENT ASSEMBLY  
(3MM SINGLE GLASS)**

- STEPS:**
1. APPLY FOAM TAPE TO ALL GLAZING BARS.
  2. INSERT (2)  $\frac{1}{4}$ " x  $\frac{3}{8}$ " BOLTS INTO EACH GLAZING BAR
  3. SECURE GLAZING BARS TO VENT HINGE & VENT GUTTER.
  4. PEEL THE BROWN PAPER FROM THE FOAM TAPE ON THE GLAZING BARS.
- CONTINUE ON NEXT PAGE

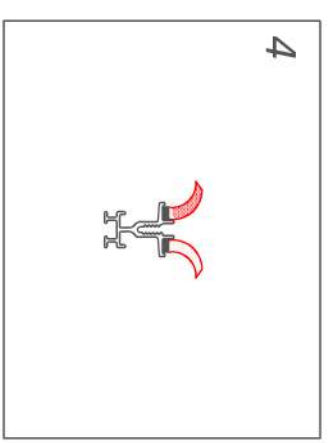
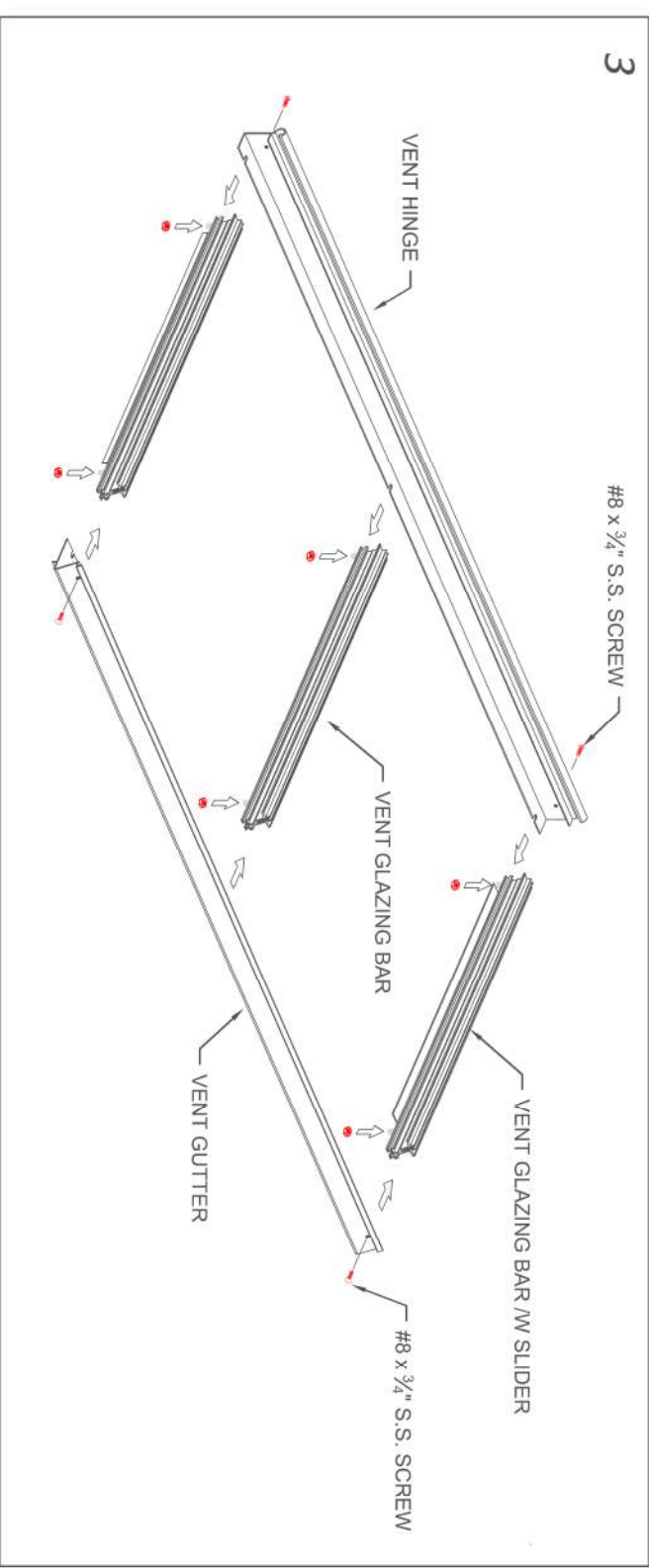
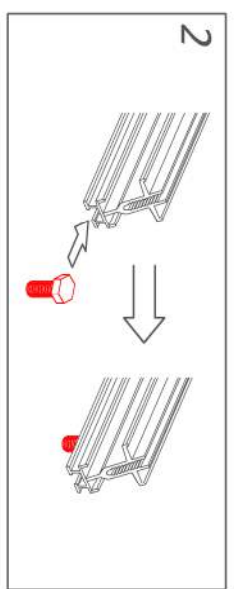
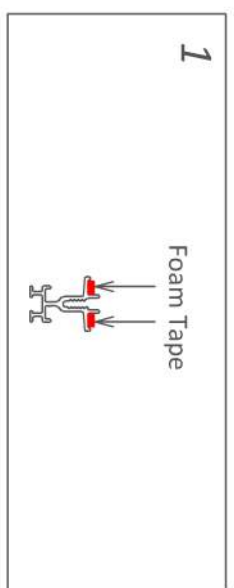

**Parts List:**

- \*Note: Do NOT Remove the sliders from glazing bar
-   
 Glazing Bars & Sliders
  -   
 Vent Gutter
  -   
 Glazing Bar
  -   
 Glazing Cap
  -   
 Vent Hinge
  - 
  - 
  - 
  - 
  - 
  -   
 Silicone
  -   
 Foam Tape

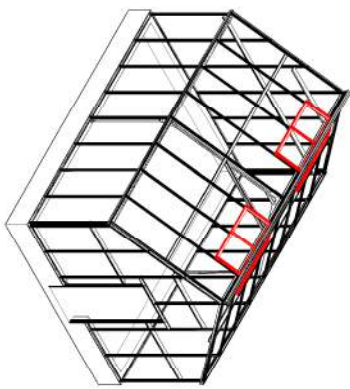

**ACCESSORIES: ROOF VENT ASSEMBLY  
(3MM SINGLE GLASS)**

- STEPS:**
5. INSERT THE GLASS PANEL INTO THE VENT HINGE & GUTTER.
  6. SECURE THE GLAZING CAPS TO THE GLAZING BARS.
  7. SEAL THE ROOF VENT WITH SILICONE.

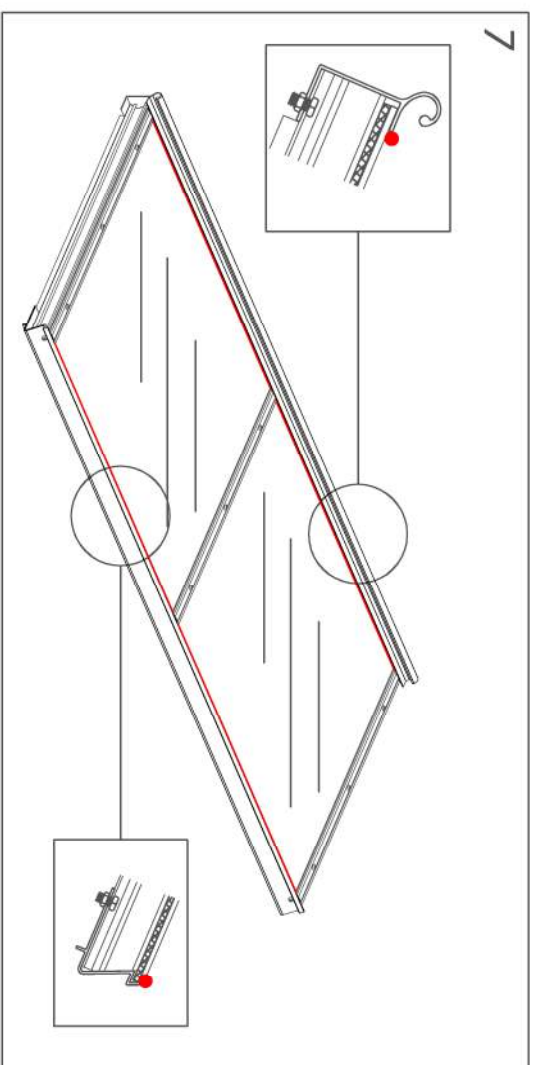
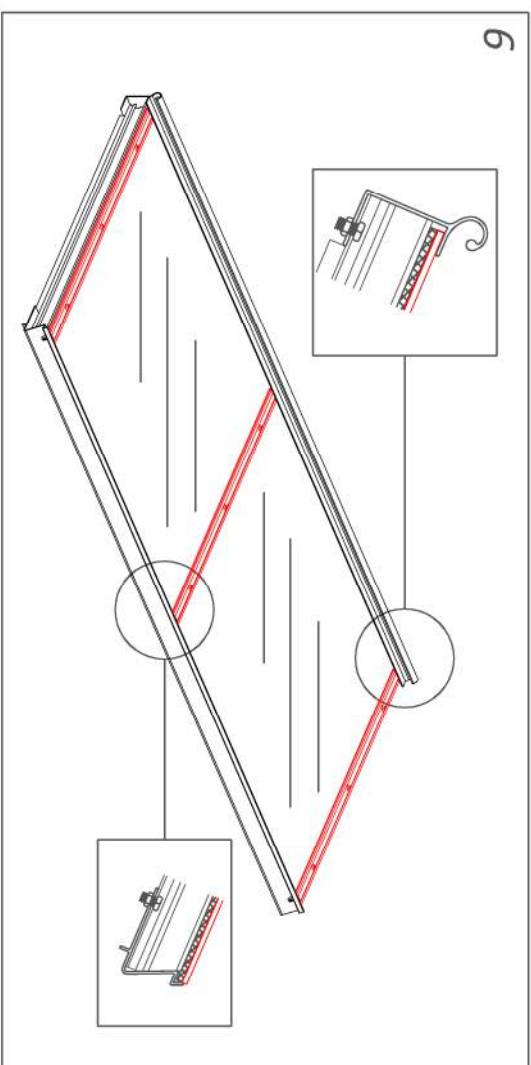
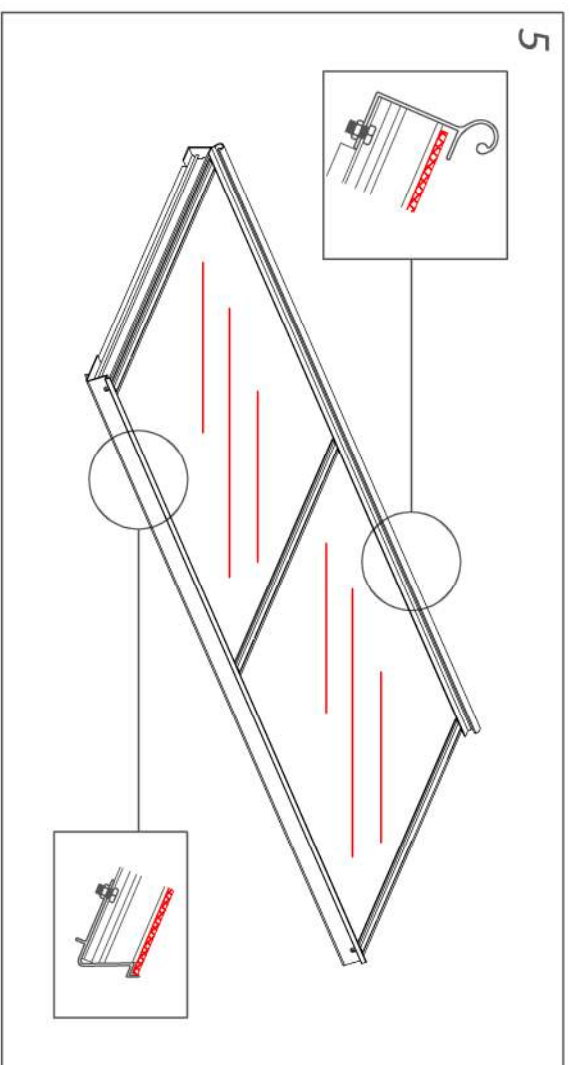

**Parts List:**

\*Note: Do NOT Remove the sliders from glazing bar

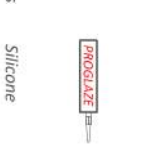
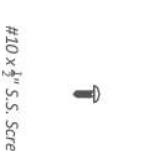
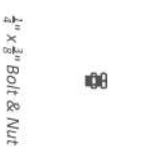
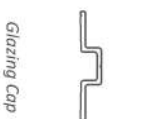
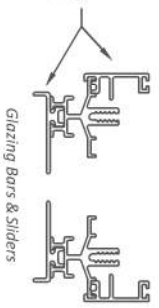

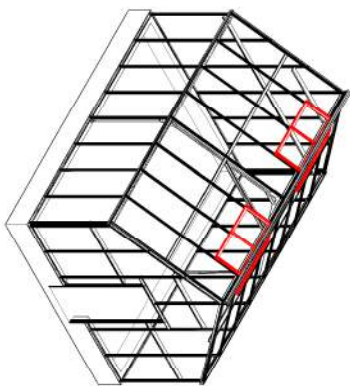



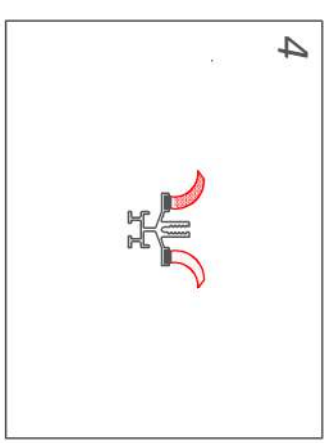
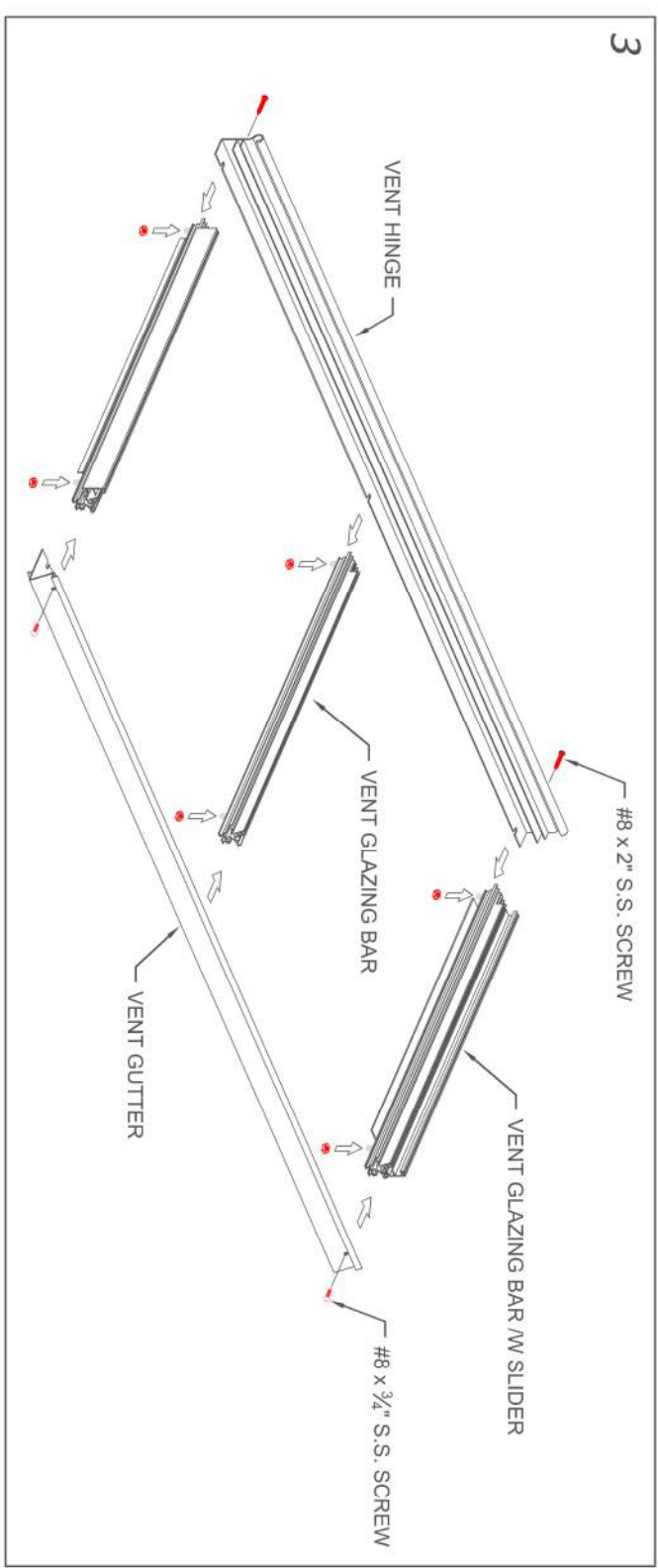
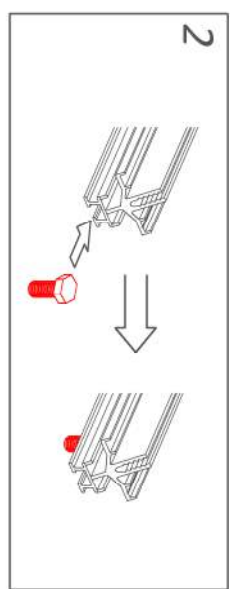
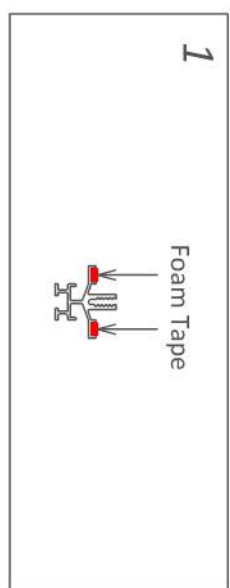

**ACCESSORIES: ROOF VENT ASSEMBLY  
(6MM SINGLE GLASS)**

- STEPS:**
1. APPLY FOAM TAPE TO ALL GLAZING BARS.
  2. INSERT (2)  $\frac{1}{4}$ " x  $\frac{3}{8}$ " BOLTS INTO EACH GLAZING BAR
  3. SECURE GLAZING BARS TO VENT HINGE & VENT GUTTER.
  4. PEEL THE BROWN PAPER FROM THE FOAM TAPE ON THE GLAZING BARS.
- CONTINUE ON NEXT PAGE

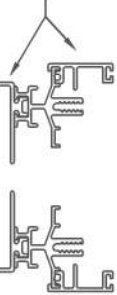

**Parts List:**

- \*Note: Do NOT Remove the sliders from glazing bar
-   
 Glazing Bars & Sliders
  -   
 Vent Gutter
  -   
 Glazing Bar
  -   
 Glazing Cap
  -   
 Vent Hinge
  -   
 h-Channels
  -   
 $\frac{1}{4}$ " x  $\frac{3}{8}$ " Bolt & Nut
  -   
 #8 x 2" S.S. Screws
  -   
 #8 x  $\frac{3}{4}$ " S.S. Screws
  -   
 #8 x  $\frac{3}{8}$ " S.S. Screws
  -   
 #10 x  $\frac{1}{2}$ " S.S. Screws
  -   
 Silicone
  -   
 Foam Tape

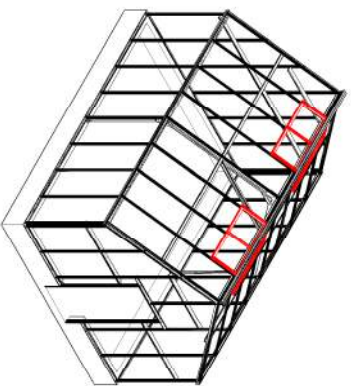

**ACCESSORIES: ROOF VENT ASSEMBLY  
(6MM SINGLE GLASS)**

- STEPS:**
5. PLACE AN H-CHANNEL ONTO THE BOTTOM END OF EACH GLASS PANEL.
  6. INSERT THE GLASS PANEL INTO THE VENT HINGE AND PRESS THE H-CHANNEL INTO THE VENT GUTTER.
  7. SECURE THE GLAZING CAPS TO THE GLAZING BARS.
  8. SEAL THE ROOF VENT WITH SILICONE.

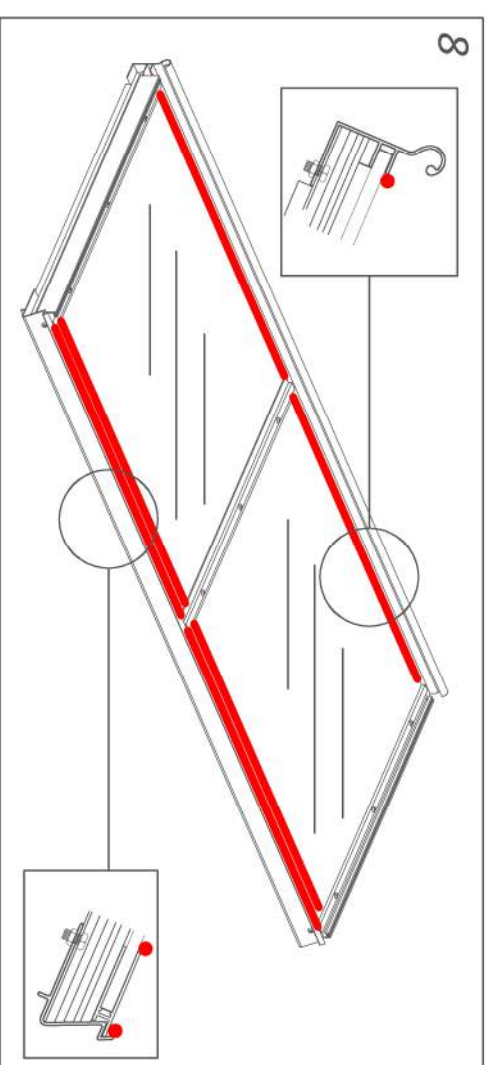
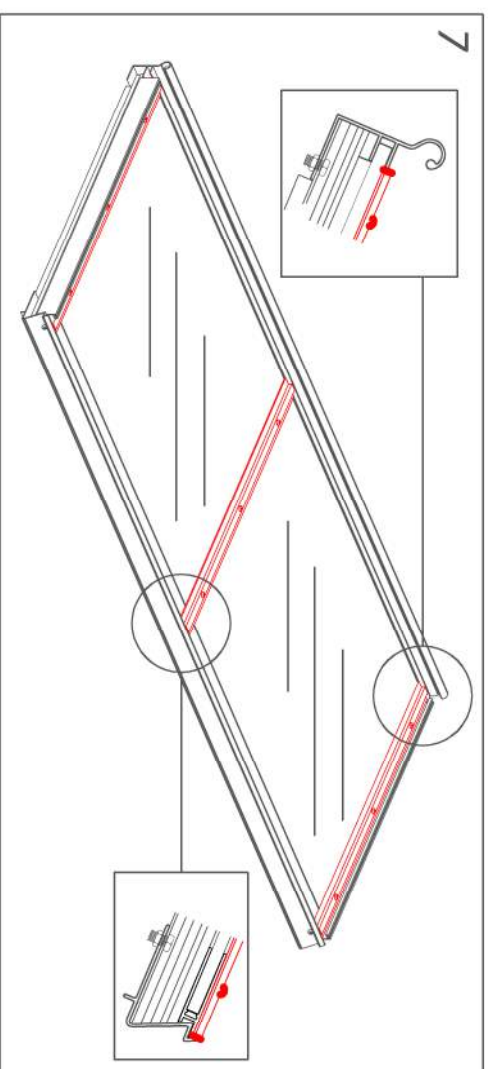
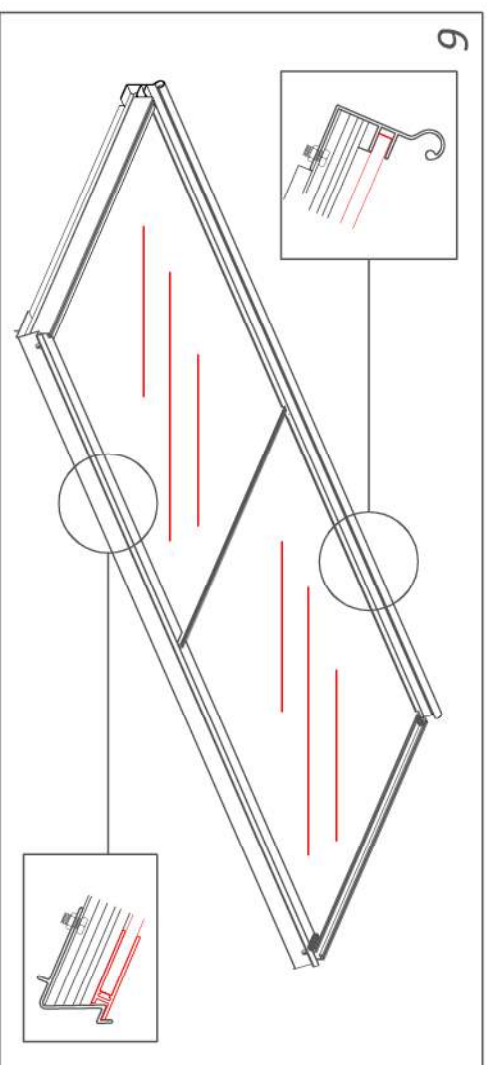
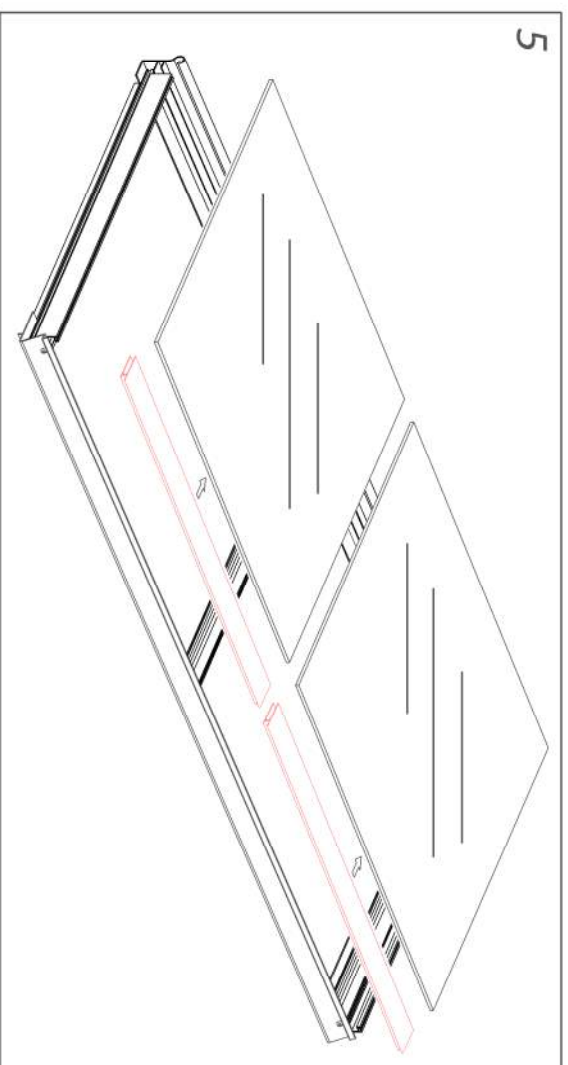

**Parts List:**

\*Note: Do NOT Remove the sliders from glazing bar

- 

Glazing Bars & Sliders
- 

Vent Gutter
- 

Glazing Bar
- 

Glazing Cap
- 

Vent Hinge
- 

H-Channels
- 

1/4 x 3/8 Bolt & Nut
- 

#8 x 2" S.S. Screws
- 

#8 x 3/4" S.S. Screws
- 

#8 x 3/8" S.S. Screws
- 

#10 x 1/2" S.S. Screws
- 

Silicone
- 

Foam Tape

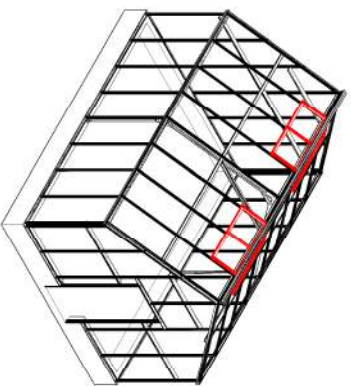

**ACCESSORIES: ROOF VENT ASSEMBLY  
(16MM DOUBLE GLASS)**

**STEPS:**

REFER TO STAGE 19 FOR FOIL TAPE APPLICATION

1. APPLY FOAM TAPE TO ALL GLAZING BARS.
2. INSERT (2)  $\frac{1}{4}$ " x  $\frac{3}{8}$ " BOLTS INTO EACH GLAZING BAR
3. SECURE GLAZING BARS TO VENT HINGE & VENT GUTTER.
4. PEEL THE BROWN PAPER FROM THE FOAM TAPE ON THE ROOFL GLAZING BARS.
5. ATTACH H-CHANNELS & SETTING BLOCKS.

CONTINUE ON NEXT PAGE

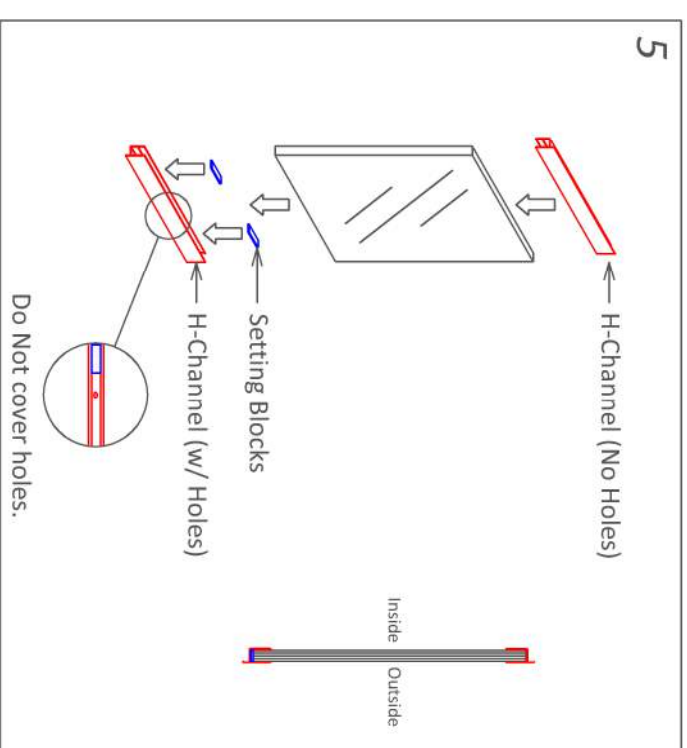
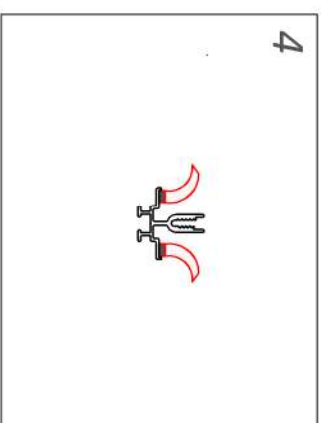
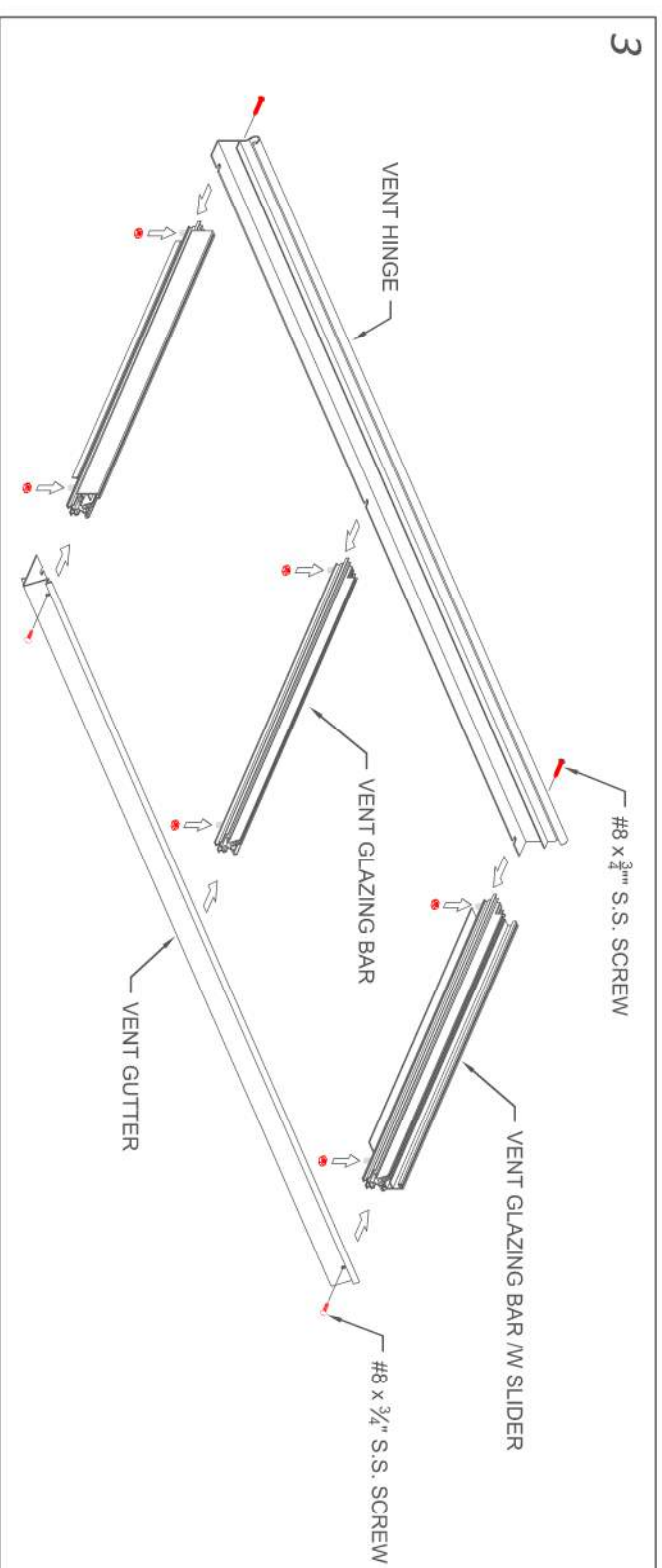
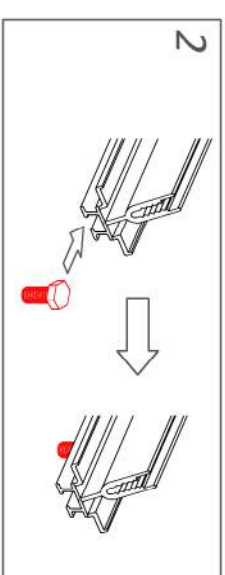
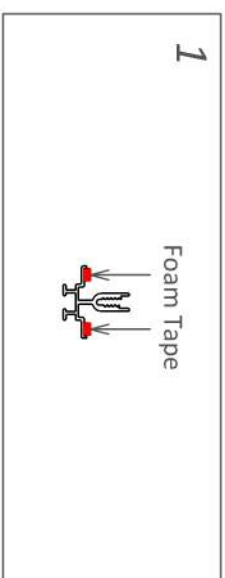

**Parts List:**

\*Note: Do NOT Remove the sliders from glazing bar

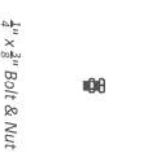
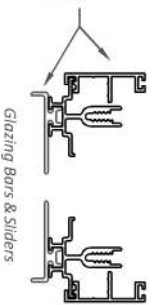



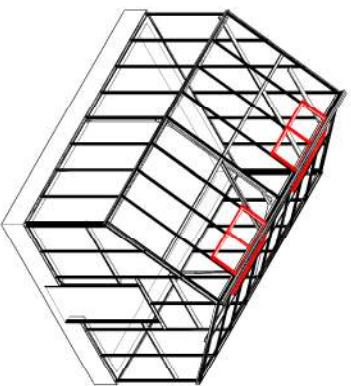







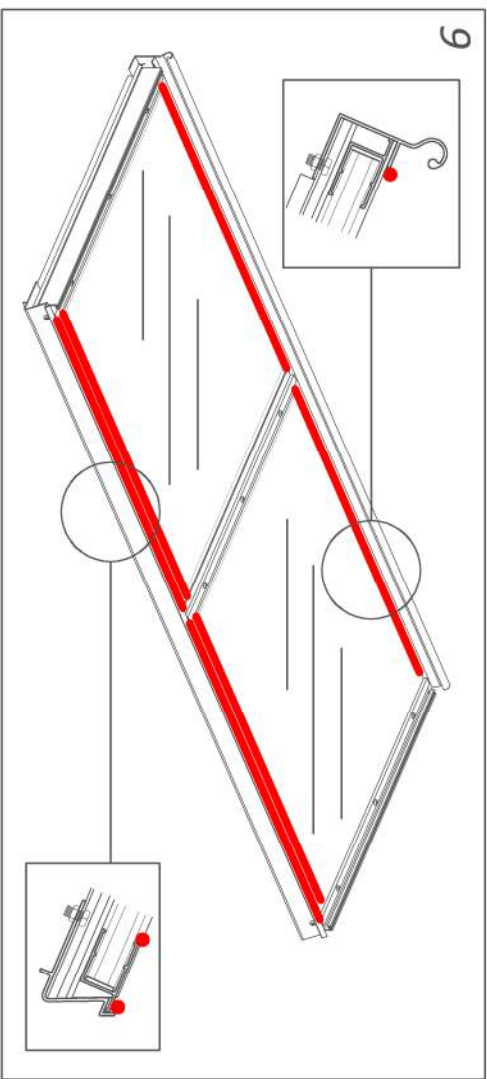
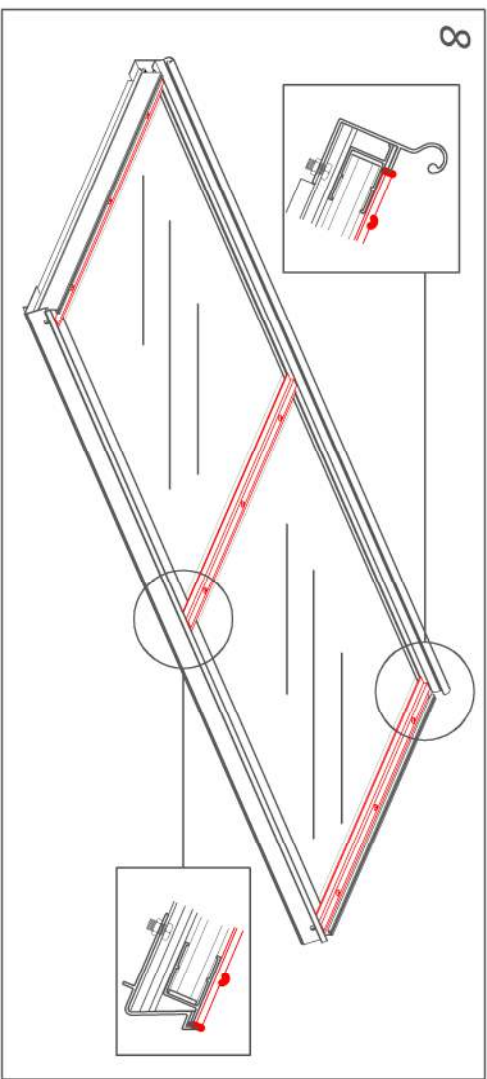
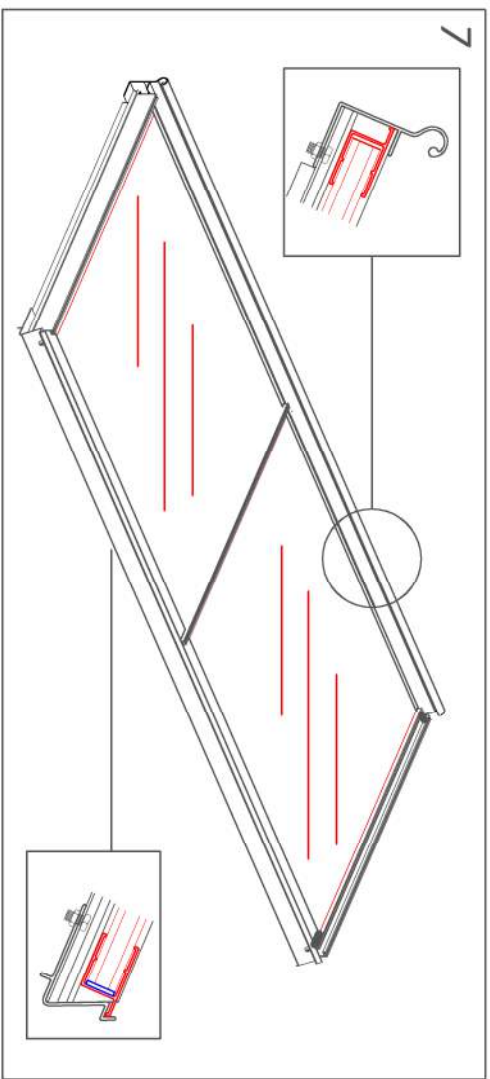



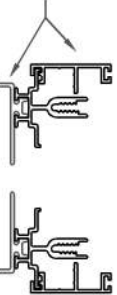

**ACCESSORIES: ROOF VENT ASSEMBLY  
(16MM DOUBLE GLASS)**

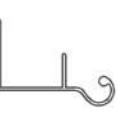
**STEPS:**

7. INSERT THE GLASS PANEL INTO THE VENT HINGE AND PRESS THE H-CHANNEL INTO THE VENT GUTTER.
8. SECURE THE GLAZING CAPS TO THE GLAZING BARS.
9. SEAL THE ROOF VENT WITH SILICONE.



**Parts List:**

- \*Note: Do NOT Remove the sliders from glazing bar
-  Glazing Bars & Sliders
  -  Vent Gutter
  -  Glazing Bar
  -  Glazing Cap
  -  Vent Hinge
  -  H-Channels
  -  Setting Block
  -  3/4" x 3/8" Bolt & Nut
  -  #8 x 3/4" S.S. Screws
  -  #10 x 1/2" S.S. Screws
  -  FRINGLAZE Silicone
  -  Foam Tape

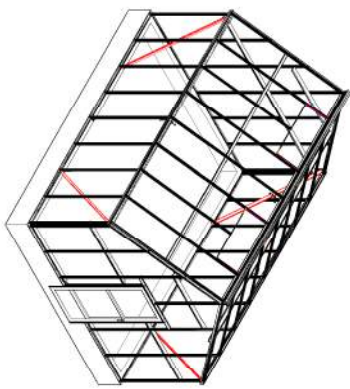

### ACCESSORIES: SIDE DIAGONAL BRACES (ALL GLAZING TYPES - COMMERCIAL)

**STEPS:**

1. REPLACE THE EXISTING  $\frac{1}{4}$ " X  $\frac{1}{2}$ " BOLT IN THE BASE AND REPLACE WITH  $\frac{1}{4}$ " X  $\frac{3}{4}$ " BOLT. INSERT A  $\frac{1}{4}$ " X  $\frac{3}{4}$ " BOLT IN THE PRE-DRILLED GUTTER HOLE.
  2. ATTACH DIAGONAL BRACE TO GUTTER & BASE AND SECURE WITH  $\frac{1}{4}$ " NUTS.
- REPEAT FOR REMAINING DIAGONAL BRACES

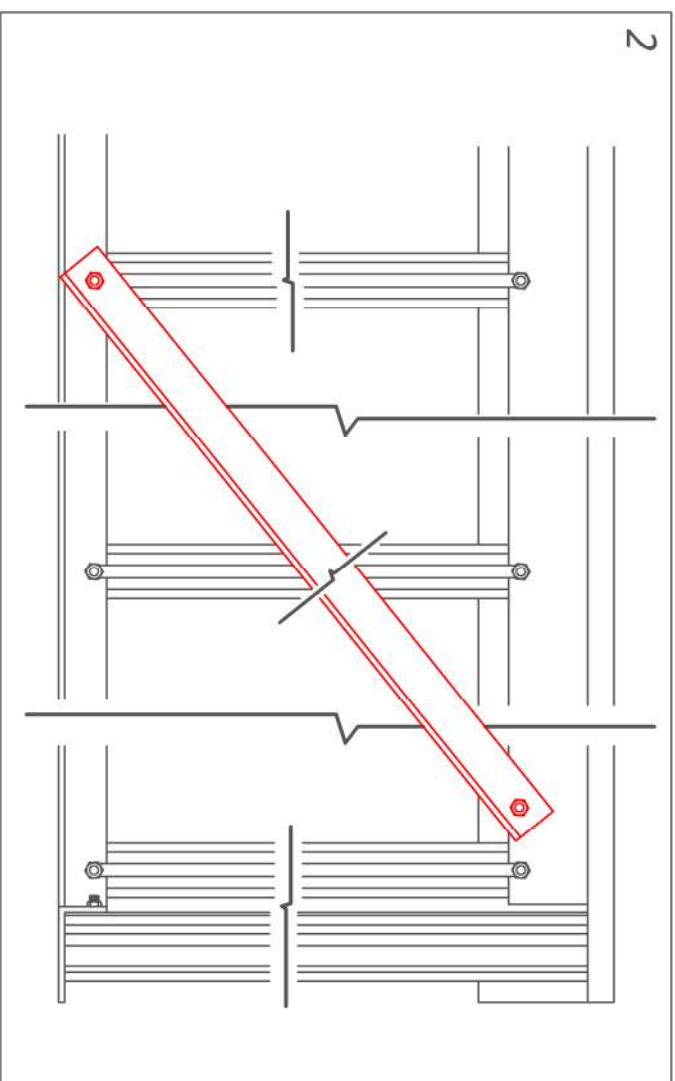
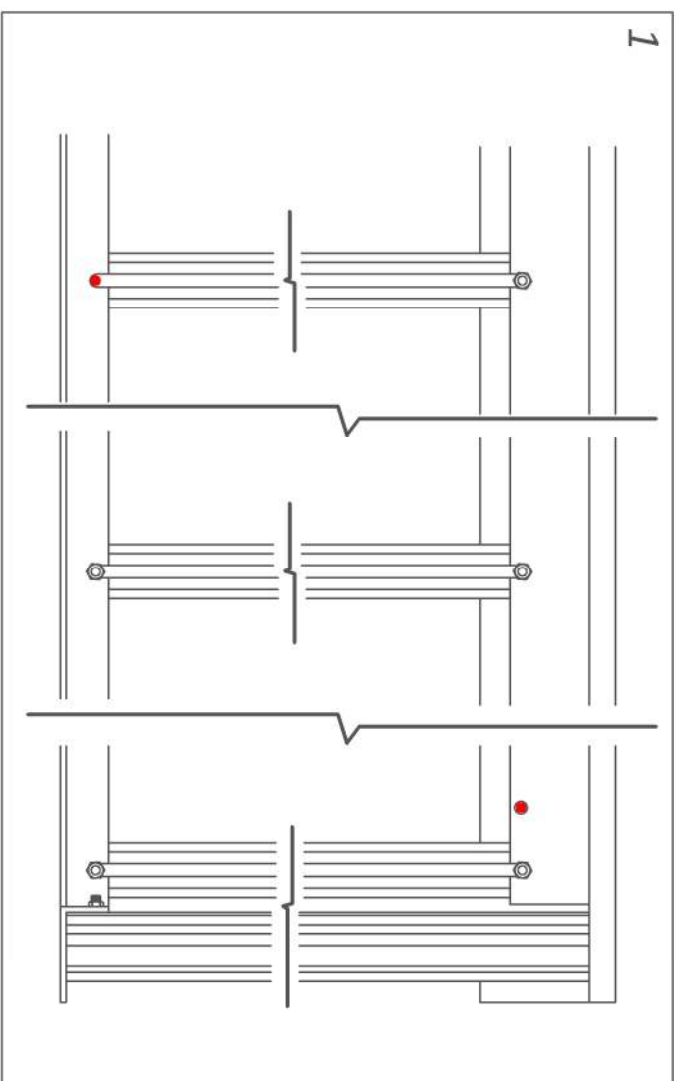

**PRO TIPS**



Refer to the job specific drawings to determine Location and Length of your Diagonal Braces (if any).

**Parts List:**



Diagonal Brace (1"x2" Angle)



$\frac{1}{4}$ " X  $\frac{3}{4}$ " S.S. Bolt & Nut



Diagonal Brace(s)

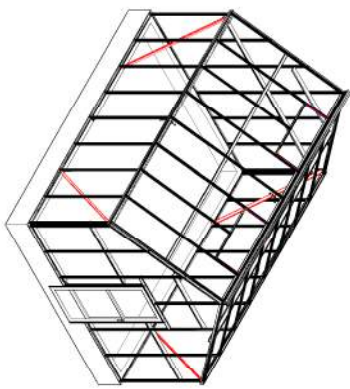

**ACCESSORIES: SIDE DIAGONAL BRACES  
(ALL GLAZING TYPES - STANDARD)**

**STEPS:**

1. REMOVE THE EXISTING  $\frac{1}{4}$ " X  $\frac{3}{4}$ " BOLTS IN THE BASE & GUTTER AND REPLACE WITH  $\frac{1}{4}$ " X  $\frac{3}{4}$ " BOLTS.
  2. ATTACH DIAGONAL BRACE TO THE BASE & GUTTER AND SECURE WITH  $\frac{1}{4}$ " NUTS.
- REPEAT FOR REMAINING DIAGONAL BRACES

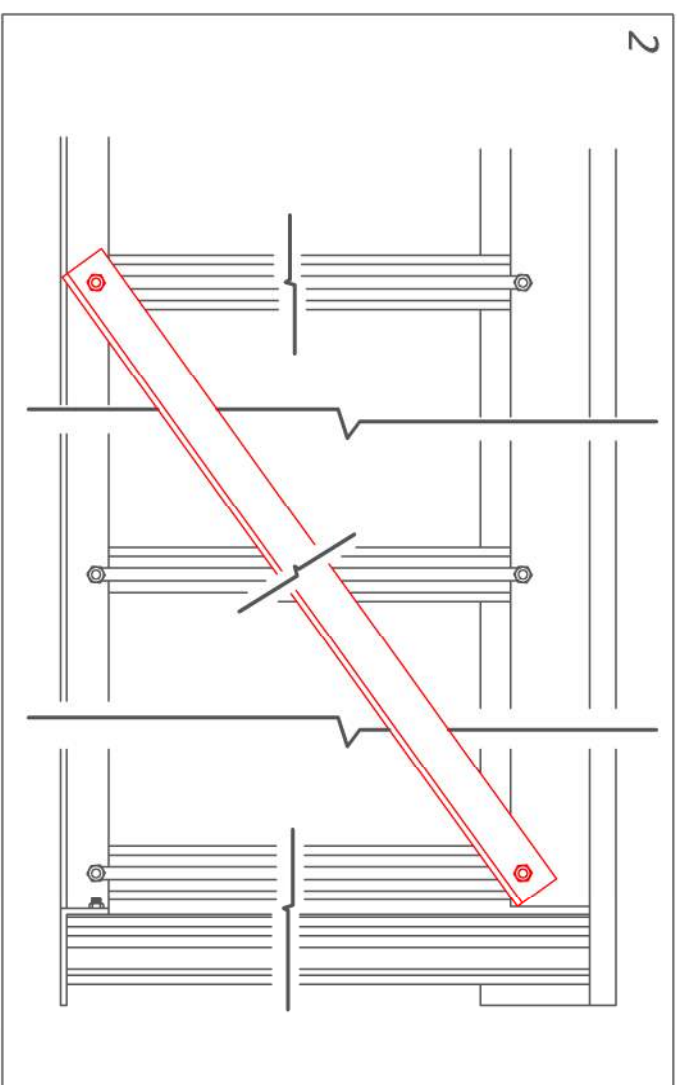
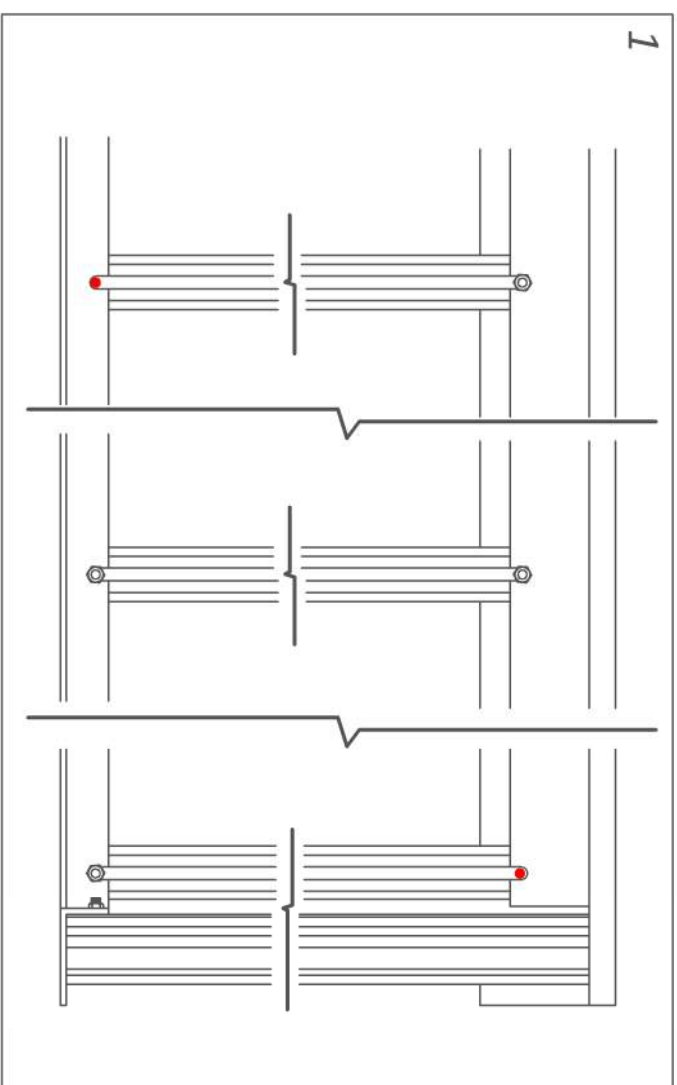

**Parts List:**



Diagonal Brace (1"x2" Angle)



$\frac{1}{4}$ " X  $\frac{3}{4}$ " S.S. Bolt & Nut



Diagonal Brace(s)

**PRO TIPS**



Refer to the job specific drawings to determine Location and Length of your Diagonal Braces (if any).

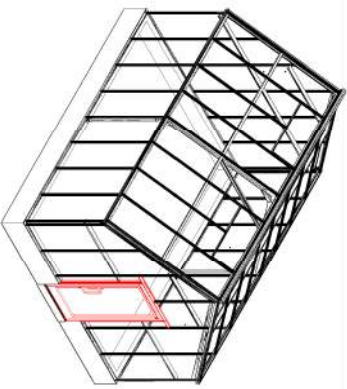

**ACCESSORIES: SINGLE STOREFRONT DOOR  
(ALL GLAZING TYPES - STANDARD CAPPING)**

**STEPS:**

1. REMOVE DOOR SLAB FROM DOOR FRAME BY DEPRESSING THE PIN LOCATED INSIDE OF THE UPPER PIVOT.
2. SECURE THE DOOR HEADER TO THE PRE-ATTACHED GLAZING BARS USING 1" #8 SCREWS
3. ATTACH DOOR FRAME TO FRONT BASE USING 1/2" X 1/2" BOLTS & NUTS

RETURN TO PAGE #5 OF THE INSTRUCTION MANUAL.

- \*ONCE GREENHOUSE IS FULLY GLAZED, REPLACE DOOR SLAB INTO FRAME.
- \*ATTACH CLOSER USING INSTRUCTION "73004RV" INCLUDED WITH CLOSER.
- \*KEY TO THE DOOR IS TAPED TO THE TOP OF THE DOOR SLAB.
- \*D-PULL HANDLE INSTRUCTION INCLUDED ON THE NEXT PAGE OF THIS INSTRUCTION MANUAL.

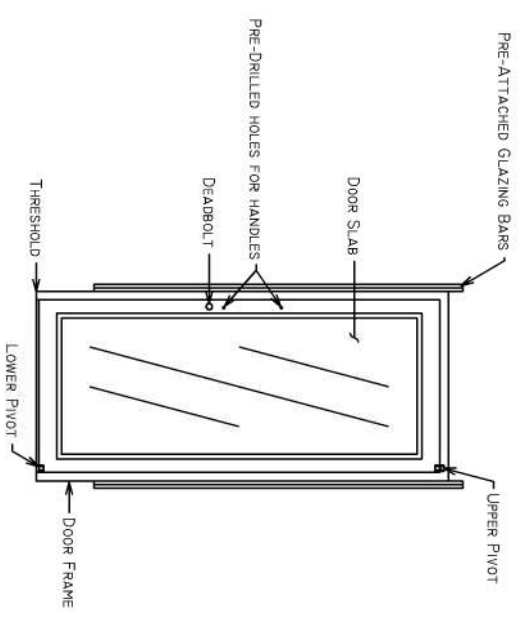
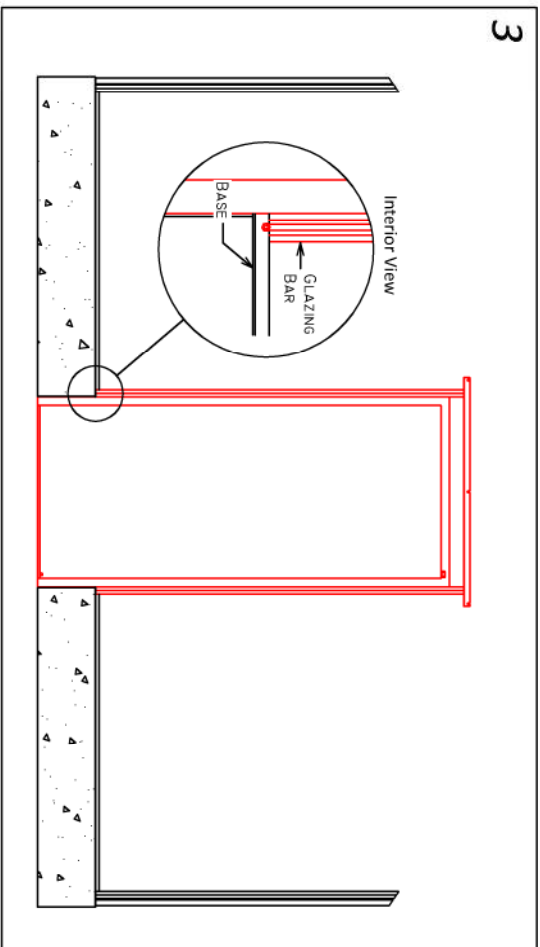
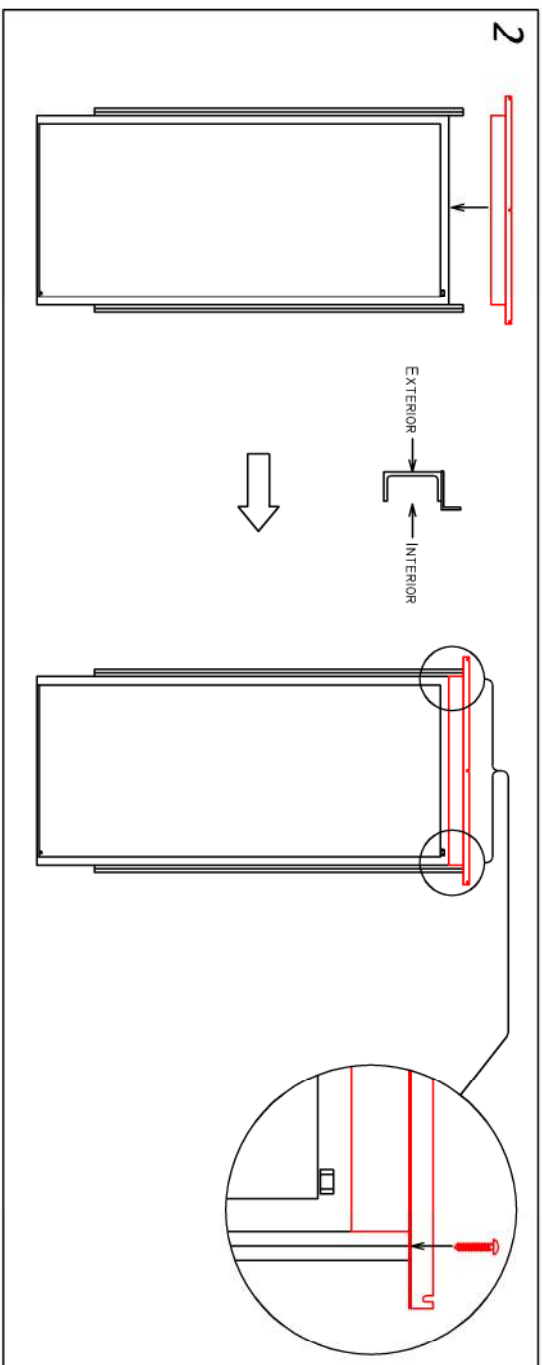
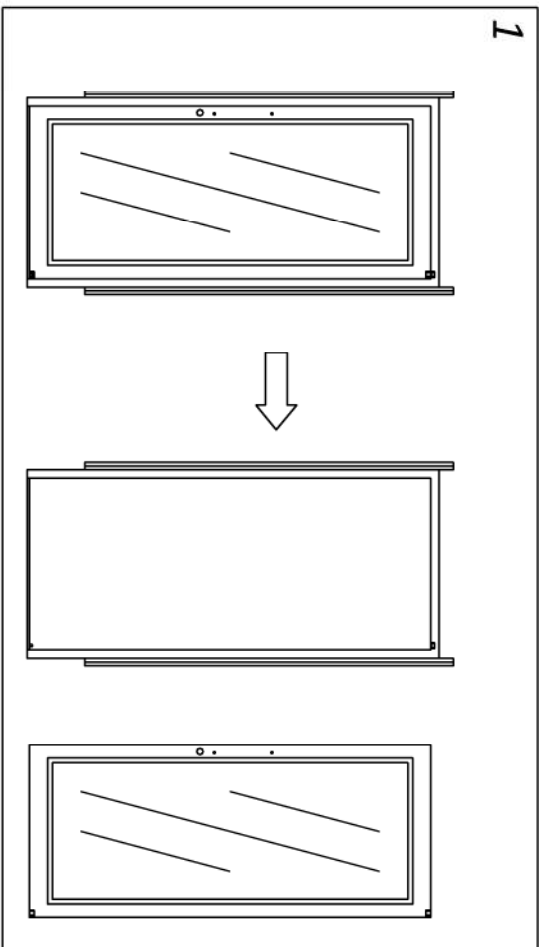
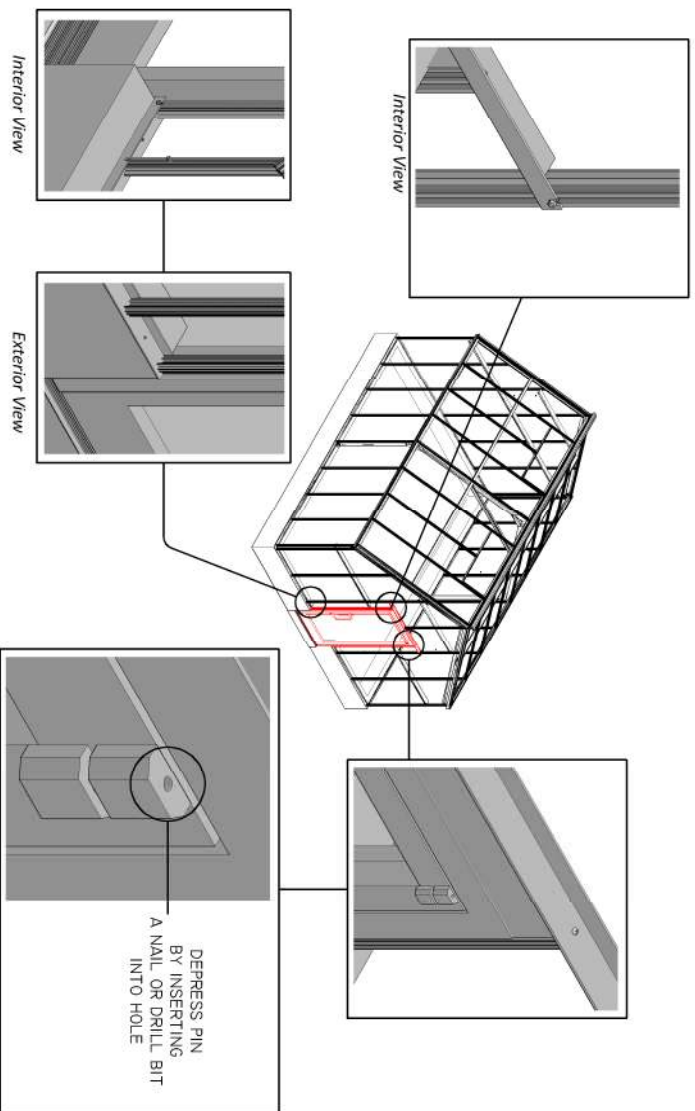

**PRO TIPS**



Storefront Doors are heavy.  
Use 2 able-bodied people when moving or disassembling

**Parts List:**

(Typical Single Storefront Door)

- 1" x 2" Angle (Header)
- 1 1/2" x 3" x 3/16" Channel (w/ 1" x 2" Angle attached) if applicable
- 2" x 4" x 1/4" Channel (w/ 1" x 2" Angle attached) if applicable
- 1/4" x 1/2" S.S. Bolts & Nuts
- #8 x 3/4" S.S. Screws

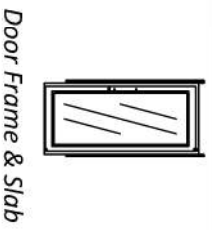

- Door Frame & Slab

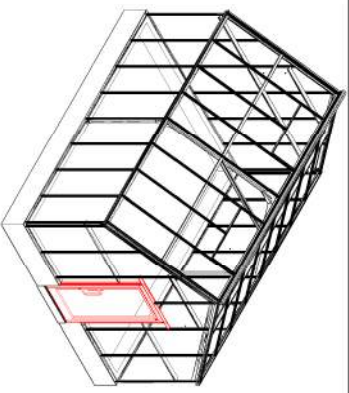

### ACCESSORIES: D-PULL HANDLES (ALL STOREFRONT DOORS)

**STEPS:**

1. SCREW BRASS PINS INTO OUTER HANDLE USING A FLAT BLADED SCREWDRIVER.
2. INSERT BRASS PINS INTO THE DOOR UNTIL THE HANDLE IS FLUSH WITH THE DOOR.
3. ATTACH THE INNER HANDLE TO THE BRASS PINS & TIGHTEN WITH AN ALLEN KEY.

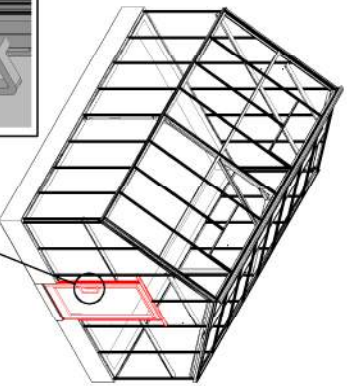
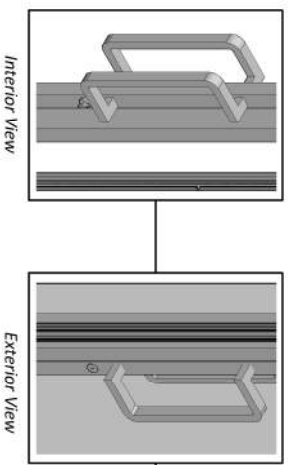
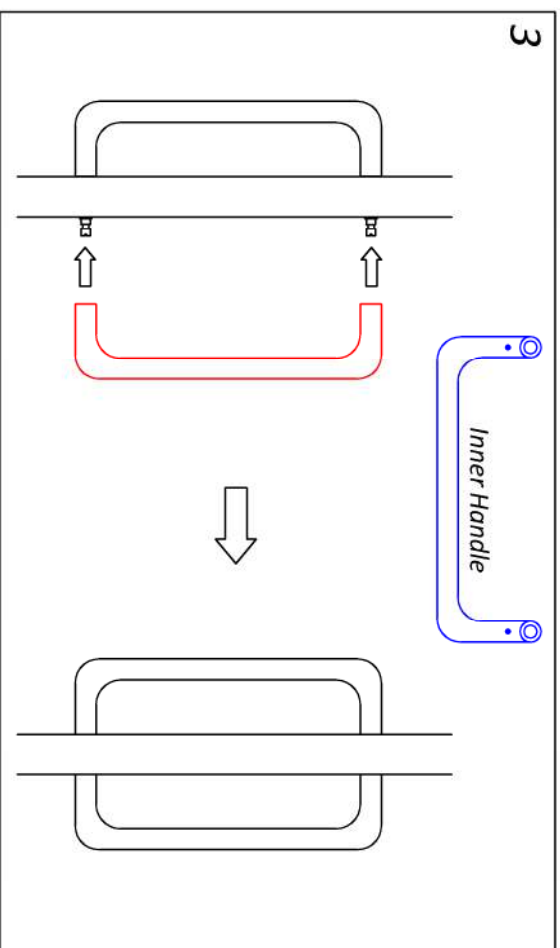
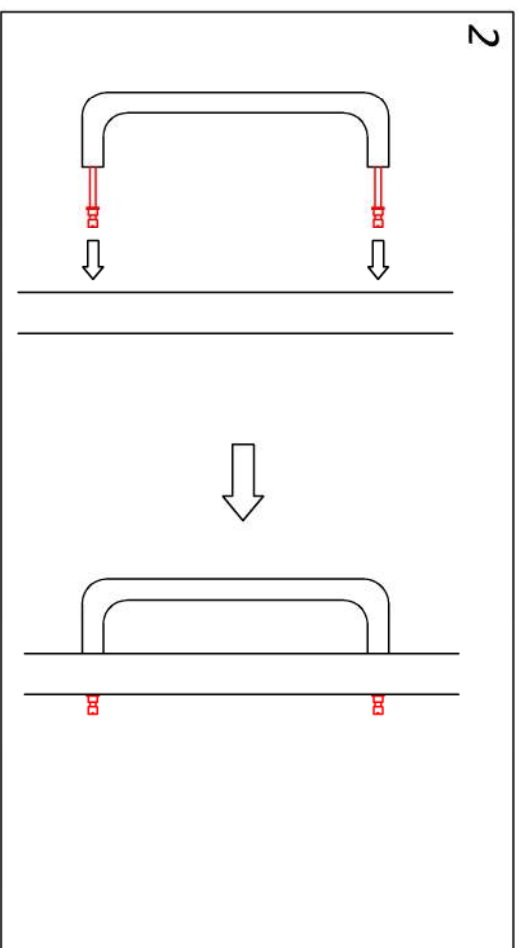
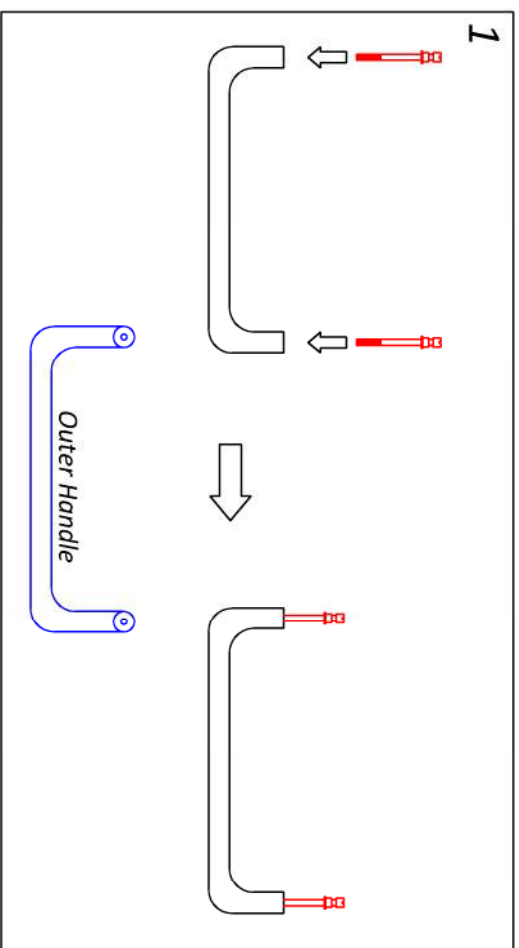

**Parts List:**

*(Typical Single Storefront Door)*



Brass Pin (x2)



Inner Handle



Outer Handle



3mm Allan Key



Flat Bladed Screw Driver

**PRO TIPS**



Use as large of a Flat-Bladed Screwdriver as possible. The pins are soft and the head can strip if you use too small of a tool.

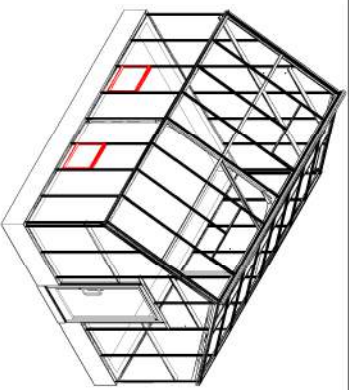

**ACCESSORIES: SINGLE SIDE VENT  
(ALL GLAZING TYPES)**

**STEPS:**

1. ATTACH SLIDERS TO GLAZING BARS AT DESIRED HEIGHT BEFORE ASSEMBLING GREENHOUSE FRAME. TYPICAL HEIGHT IS 6" ABOVE THE FOUNDATION.

*FINISH ASSEMBLING THE FRAME OF YOUR GREENHOUSE AND RETURN TO THIS STAGE BEFORE BEGINNING YOUR GLAZING.*

2. INSTALL THE DESIGNATED GLAZING MATERIAL FOR BELOW THE SIDE VENT.
3. ATTACH THE SIDE VENT SILL TO THE GREENHOUSE FRAME ON TOP OF THE GLAZING BUT BELOW THE SLIDERS USING 1/4" X 1/2" BOLTS & NUTS. SLIDERS SHOULD REST ON TOP OF THE SIDE VENT SILL.
4. ATTACH THE SIDE VENT HEADER TO THE GREENHOUSE FRAME ON TOP OF THE SLIDERS USING 1/4" X 1/2" BOLTS & NUTS.

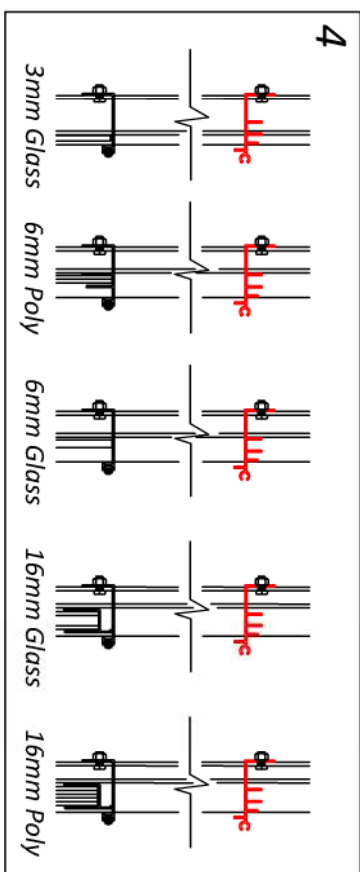
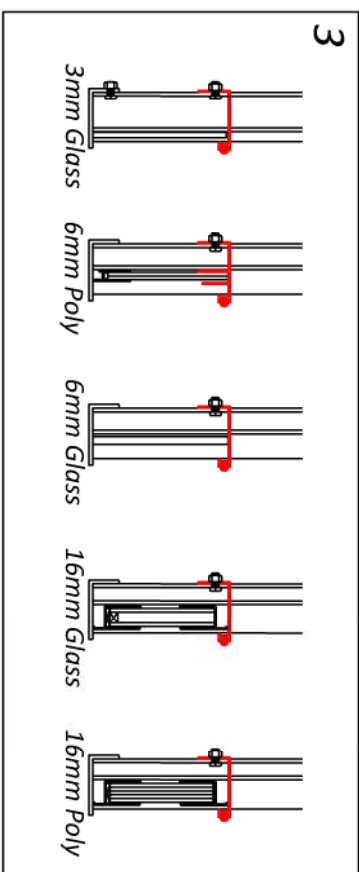
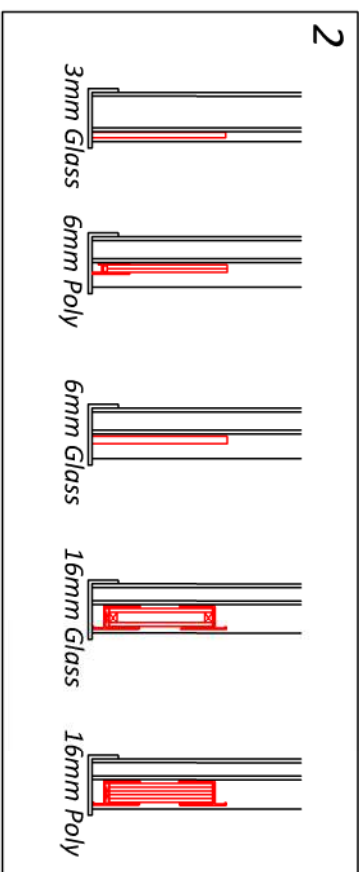
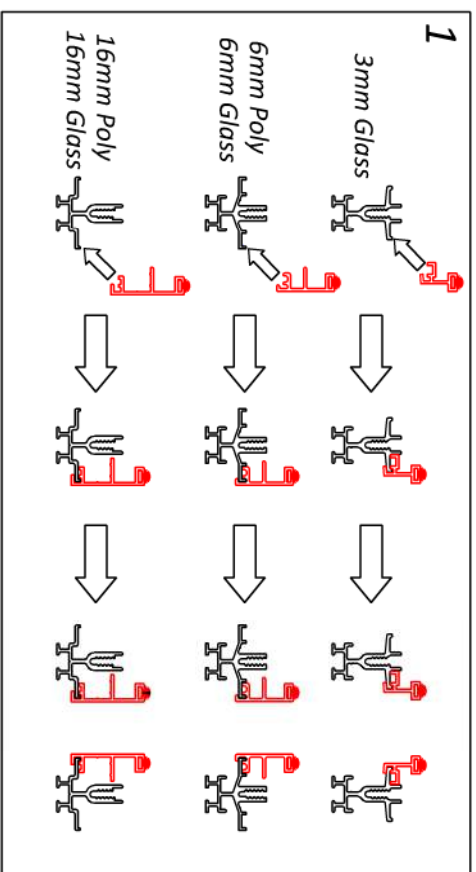
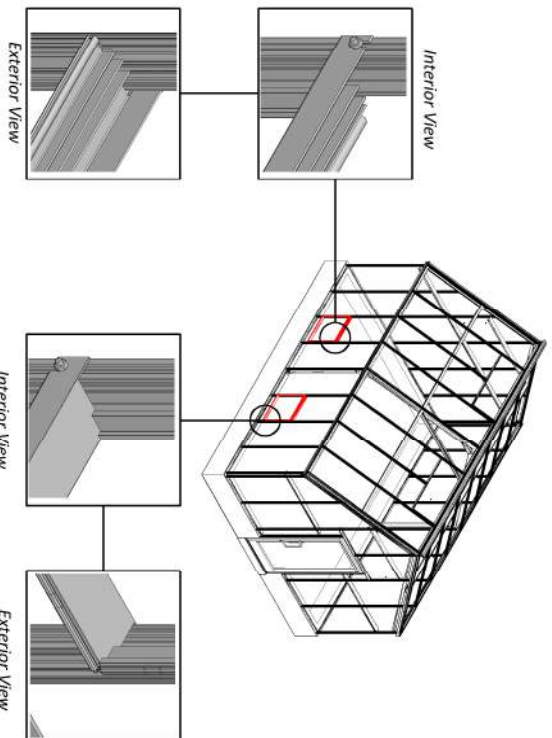

**PRO TIPS**

The Side Vent Sliders **MUST** be installed before you begin glazing the greenhouse. If you have trouble figuring out how to attach the Sliders, look at your Roof Glazing Bars with the Roof Vent Sliders pre-attached.

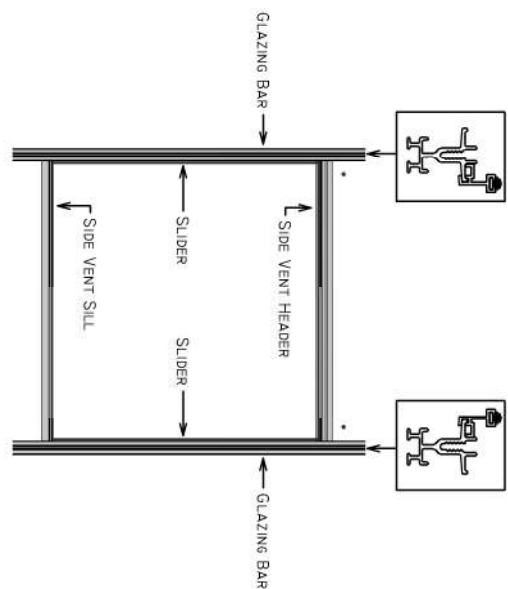

**Parts List:**

- Slider x 2 (3mm Glass)
- Slider x 2 (6mm Glass & Poly.)
- Slider x 2 (16mm Glass & Poly.)
- Side Vent Sill (6mm Polycarbonate)
- Side Vent Sill (All other glazing types)
- Side Vent Header (All glazing types)
- Side Vent (Pre-assembled)
- 1/4" x 1/2" S.S. Bolts & Nuts

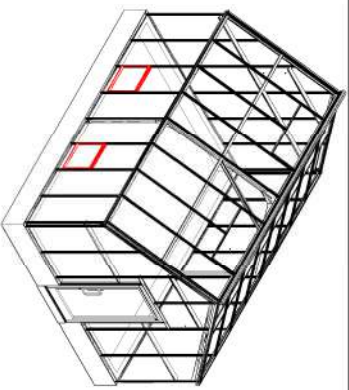

**ACCESSORIES: SINGLE SIDE VENT  
(ALL GLAZING TYPES)**

**STEPS:**

5. INSTALL THE DESIGNATED GLAZING MATERIAL FOR ABOVE THE SIDE VENT.
6. INSERT THE SIDE VENT ITSELF INTO THE CURL ON THE SIDE VENT HEADER UNTIL IT IS EVENLY CENTERED.

ATTACH THE SUPPLIED OPENER AS PER THE MANUFACTURERS INSTRUCTIONS.

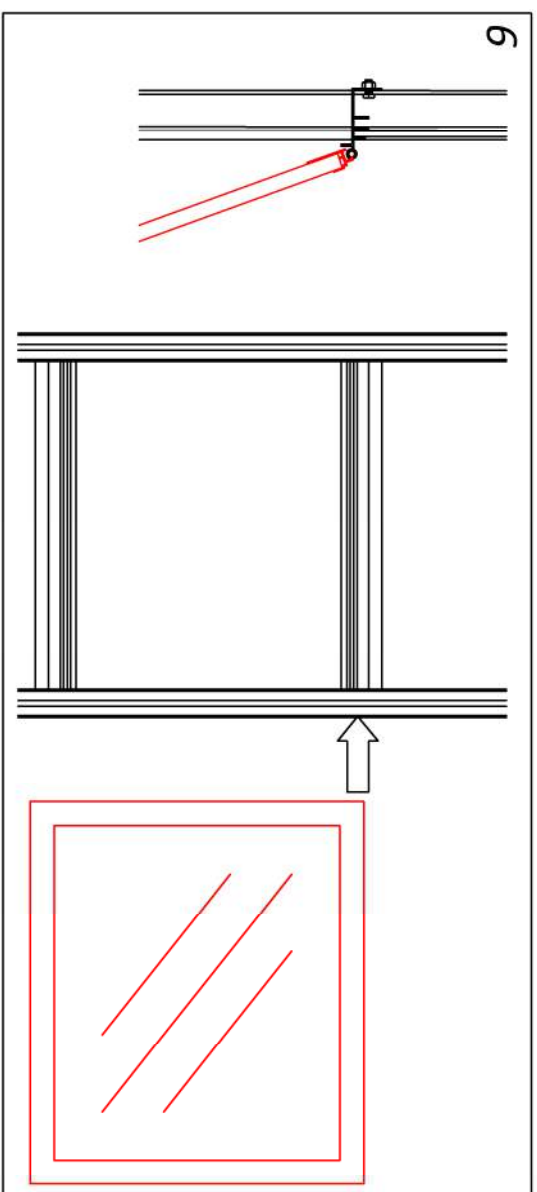
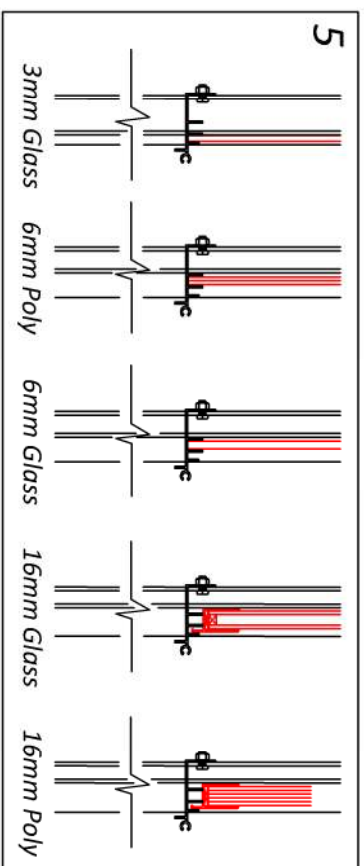





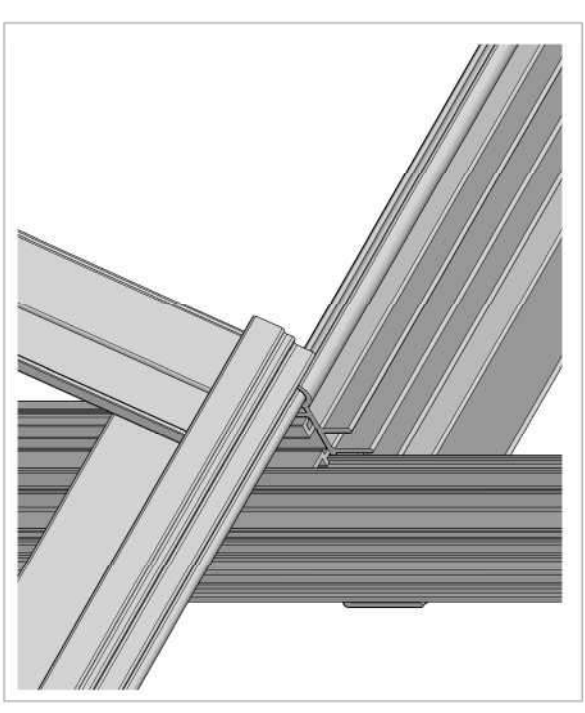
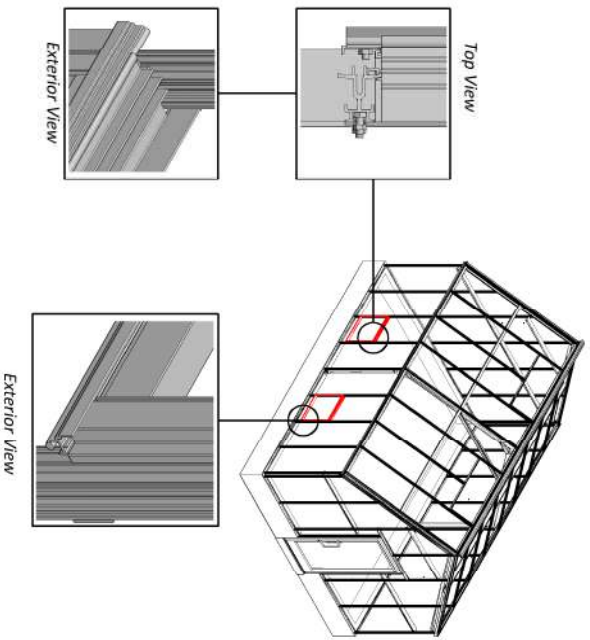



**PRO TIPS**

The Side Vent Sliders **MUST** be installed before you begin glazing the greenhouse. If you have trouble figuring out how to attach the Sliders, look at your Roof Glazing Bars with the Roof Vent Sliders pre-attached.

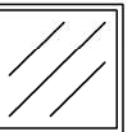

**Parts List:**

-  Slider x 2 (3mm Glass)
-  Slider x 2 (6mm Glass & Poly.)
-  Slider x 2 (16mm Glass & Poly.)
-  Side Vent Sill (6mm Polycarbonate)
-  Side Vent Sill (All other glazing types)
-  Side Vent Header (All glazing types)
-  Side Vent (Pre-assembled)
-  1/4" x 1/2" S.S. Bolts & Nuts

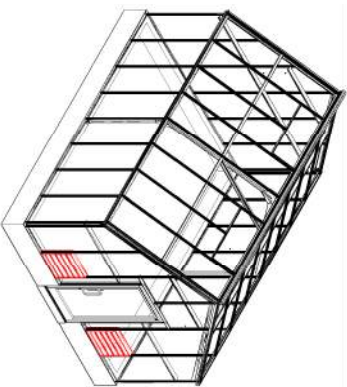

**ACCESSORIES: INTAKE SHUTTER  
(ALL GLAZING TYPES)**

**STEPS:**

1. INSERT (4) 1/4" X 1/2" BOLTS INTO THE BACK SIDE OF THE APPROPRIATE GLAZING BARS.  
[(2) IN EACH BAR]
2. FROM INSIDE THE GREENHOUSE, PLACE THE INTAKE SHUTTER IN THE APPROPRIATE LOCATION AND REST IT ON TOP OF THE BASE WHILE LINING UP THE BOLTS & PRE-DRILLED HOLES.
3. SECURE TO THE GLAZING BARS USING 1/4" NUTS.

CONTINUE GLAZING ABOVE THE INTAKE SHUTTER AS NORMAL.

**HAVE INTAKE SHUTTER CONNECTED & WIRED BY A QUALIFIED ELECTRICIAN**

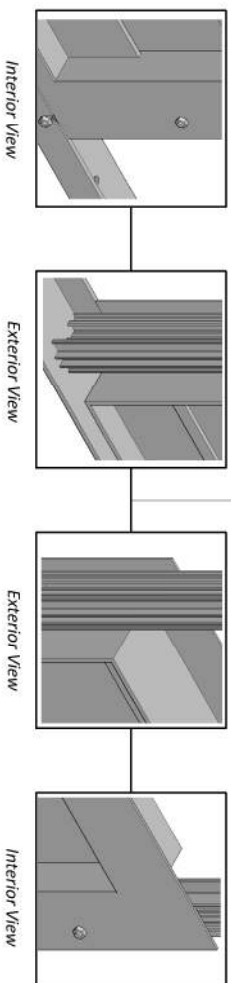
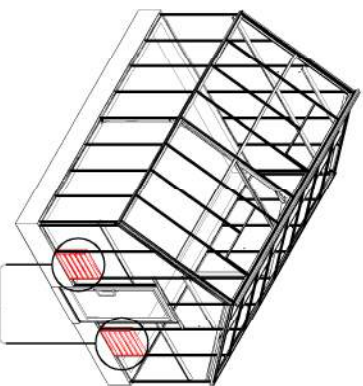

**Parts List:**

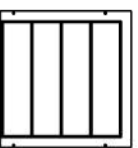

Intake Shutter



1/4" x 1/2" S.S. Bolts & Nuts

1

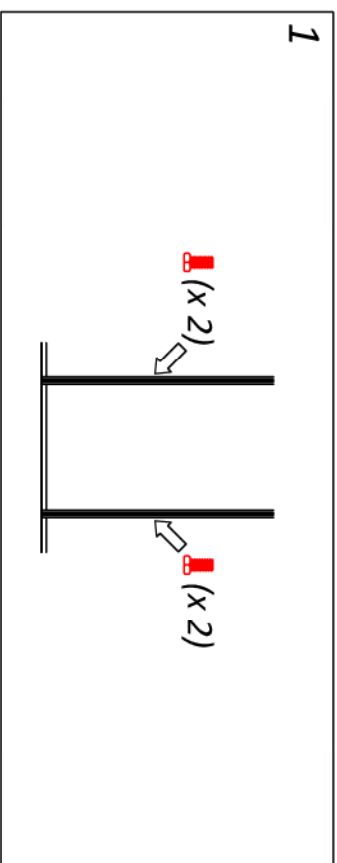

2

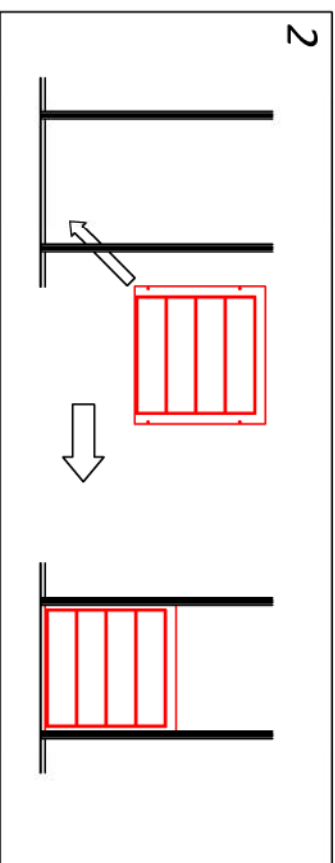

3

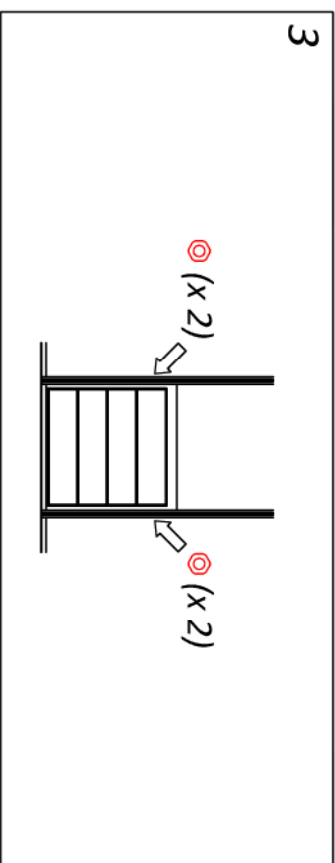

**PRO TIPS**



Any Electrical Component in your greenhouse must be wired by a Qualified Professional in accordance with Local & State Regulations. BC Greenhouse Builders will not offer advice on connecting Electrical Components.



Front View

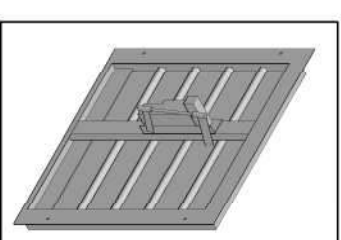

Back View



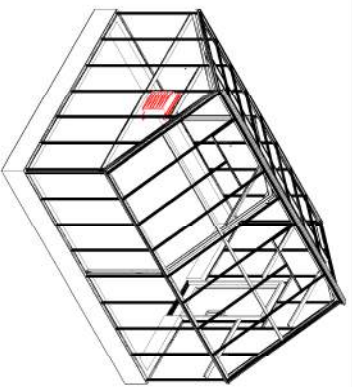

**ACCESSORIES: EXHAUST FAN  
(3MM SINGLE GLASS, TWINWALL POLYCARBONATE  
& 5WALL POLYCARBONATE)**

**STEPS:**

DO NOT INSTALL THE EXHAUST FAN UNTIL YOU HAVE GAZED THE GREENHOUSE. YOU WILL HAVE ONE PIECE OF GLAZING CUT TO ACCOMMODATE THE EXHAUST FAN.

1. INSERT (4) 1/4" X 1/2" BOLTS INTO THE BACK SIDE OF THE APPROPRIATE GLAZING BARS. [(2) IN EACH BAR]
2. FROM INSIDE THE GREENHOUSE, INSERT THE EXHAUST FAN THROUGH THE PRECUT FAN HOLE. MOUNTING BRACKETS SHOULD COME PRE-ATTACHED TO THE FAN.
3. SECURE THE MOUNTING BRACKETS TO THE GLAZING BARS USING 1/4" NUTS.
4. SEAL AROUND THE EXHAUST FAN WHERE IT PROTRUDES THROUGH THE GLAZING.

**HAVE EXHAUST FAN CONNECTED & WIRED BY A QUALIFIED ELECTRICIAN**

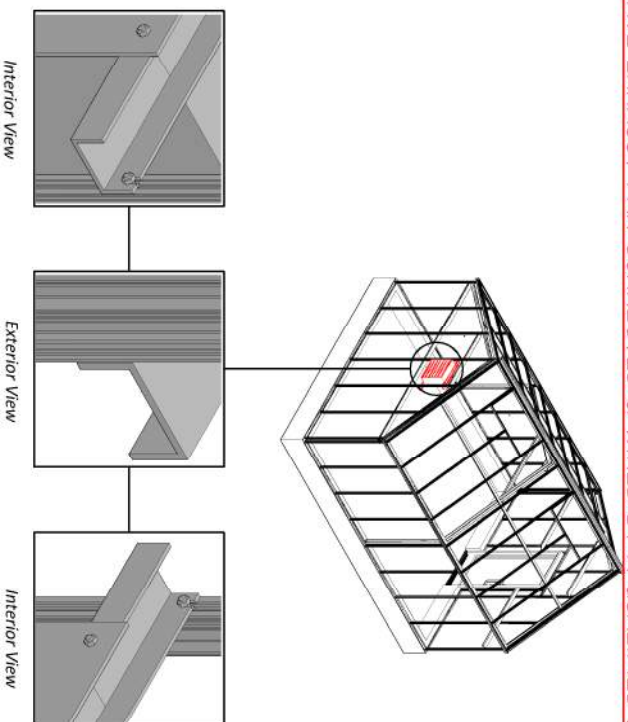

**Parts List:**



1/4" x 1/2" S.S. Bolts & Nuts



Silicone

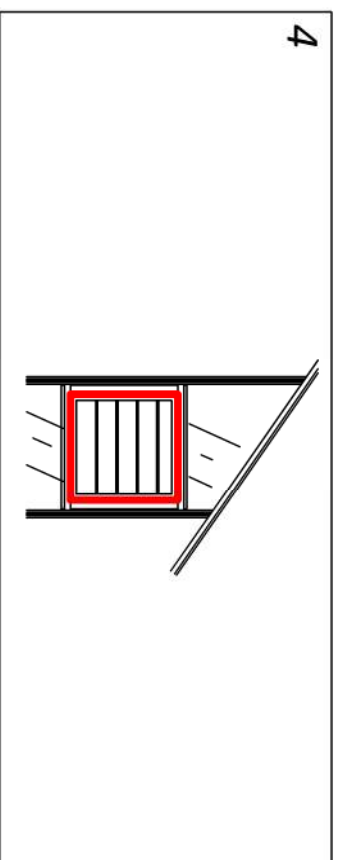
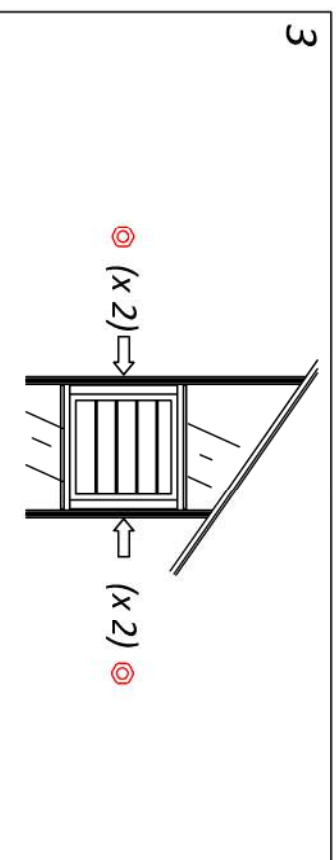
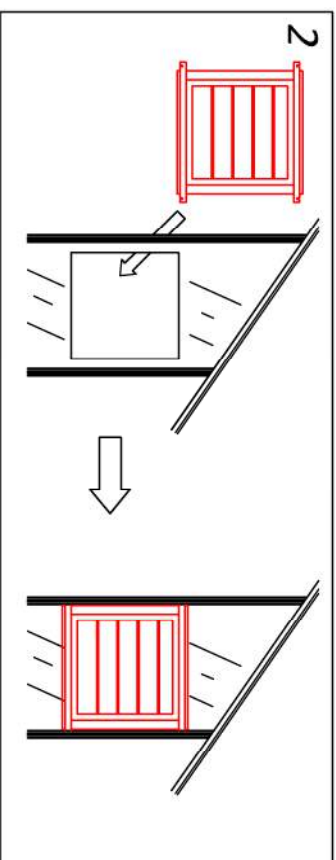
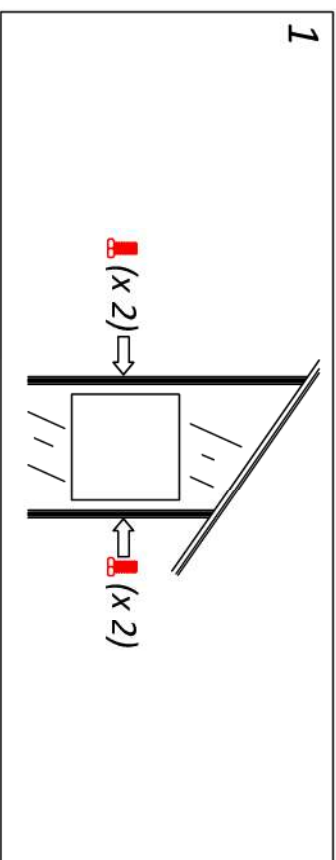

**PRO TIPS**



Any Electrical Component in your greenhouse must be wired by a Qualified Professional in accordance with Local & State Regulations. BC Greenhouse Builders will not offer advice on connecting Electrical Components.

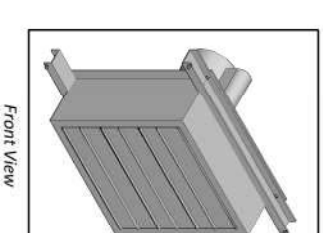

Front View

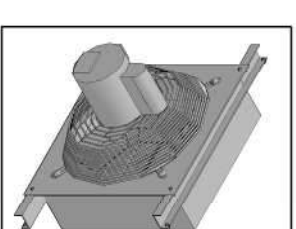

Back View

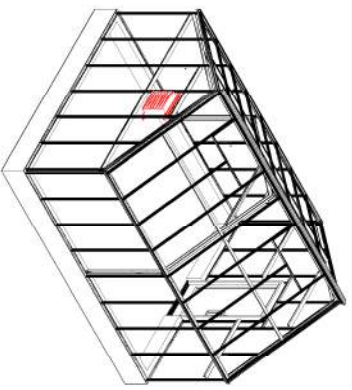

**ACCESSORIES: EXHAUST FAN  
(6MM SINGLE GLASS, 16MM DOUBLE GLASS)**

- STEPS:**
1. INSTALL THE APPROPRIATE GLASS PANEL DESIGNATED FOR BELOW THE FAN.
  2. INSERT (4) 1/4" X 1/2" BOLTS INTO THE BACK SIDE OF THE APPROPRIATE GLAZING BARS. [(2) IN EACH BAR]
  3. REST (2) SETTING BLOCKS ON TOP OF THE GLASS PANEL
  4. FROM INSIDE THE GREENHOUSE, INSERT THE EXHAUST FAN BETWEEN THE GLAZING BARS AND REST IT ON TOP OF THE SETTING BLOCKS WHILE CONNECTING TO THE BOLTS INSTALLED IN STEP 2.

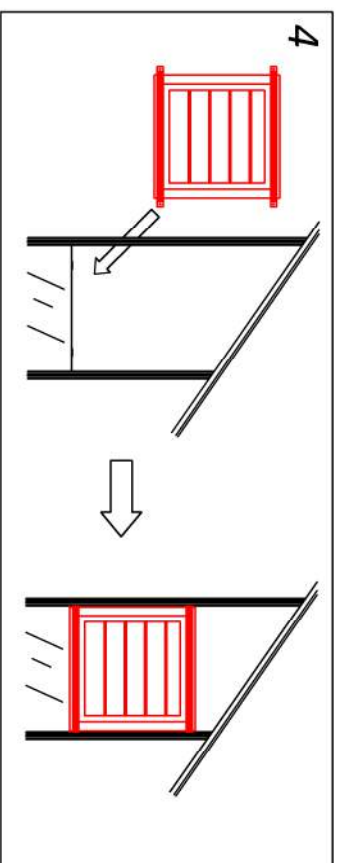
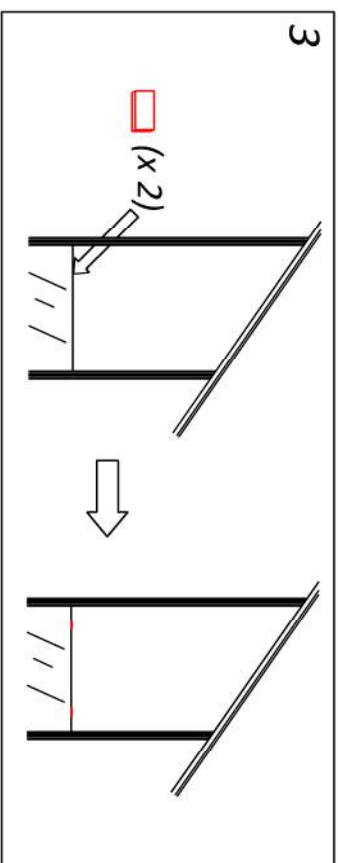
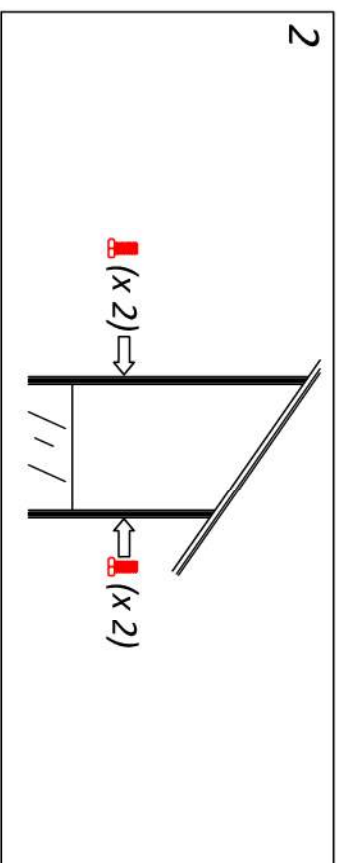
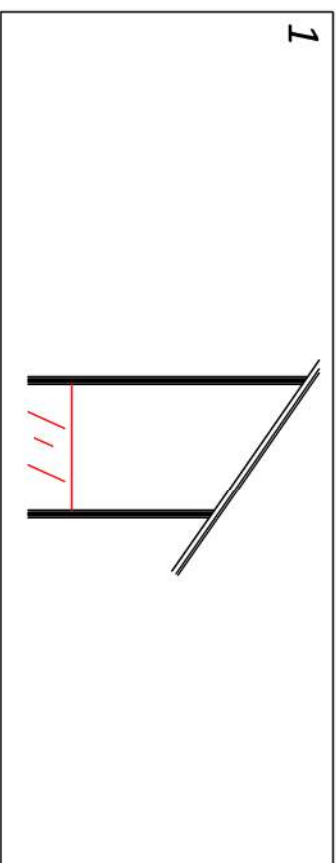
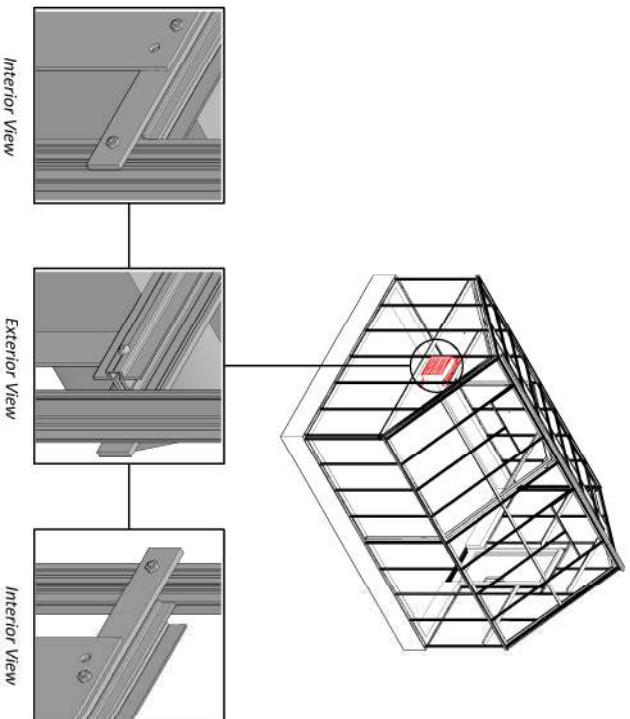

**PRO TIPS**



Any Electrical Component in your greenhouse must be wired by a Qualified Professional in accordance with Local & State Regulations. BC Greenhouse Builders will not offer advice on connecting Electrical Components.

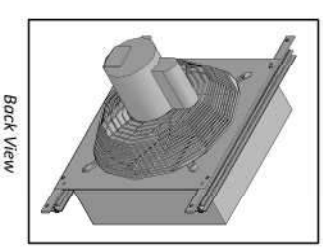
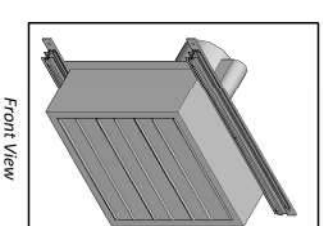

**Parts List:**



Exhaust Fan



1/4" x 1/2" S.S. Bolts & Nuts



Silicone



Setting Block  
(Double Glass Models)

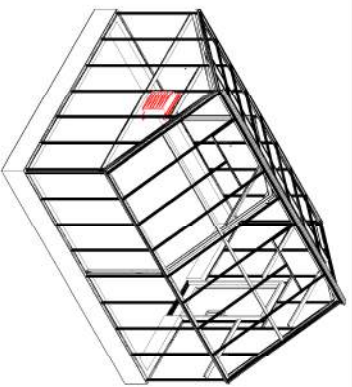

**ACCESSORIES: EXHAUST FAN  
(6MM SINGLE GLASS, 16MM DOUBLE GLASS)**

- STEPS:**
5. SECURE THE FAN TO THE GLAZING BARS WITH 1/4" NUTS.
  6. INSTALL THE APPROPRIATE FILLERS ON EITHER SIDE OF THE FAN.
  7. CONTINUE GLAZING & CAPPING ABOVE THE FAN AS NORMAL.
  8. SEAL AROUND THE EXHAUST FAN WHERE IT PROTRUDES THROUGH THE GLAZING.

**HAVE EXHAUST FAN CONNECTED & WIRED BY A QUALIFIED ELECTRICIAN**

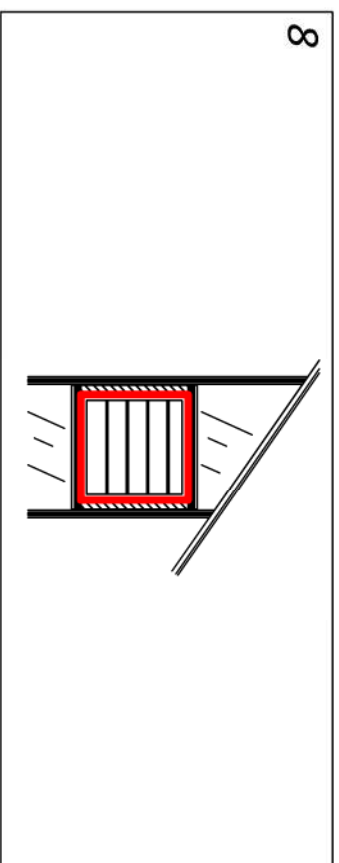
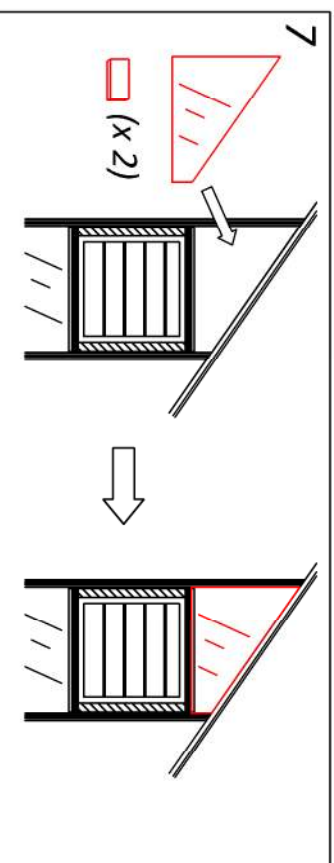
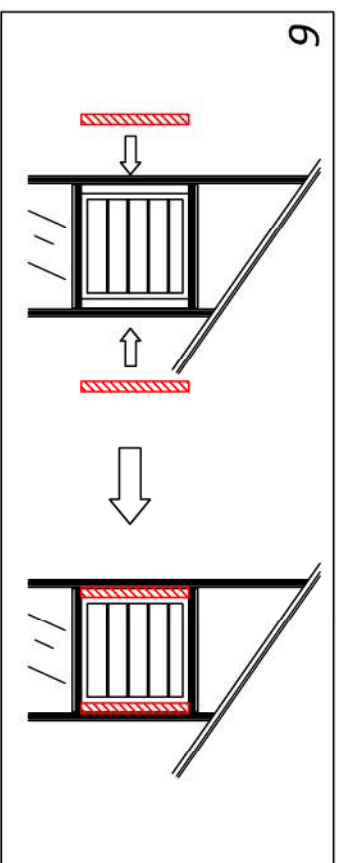
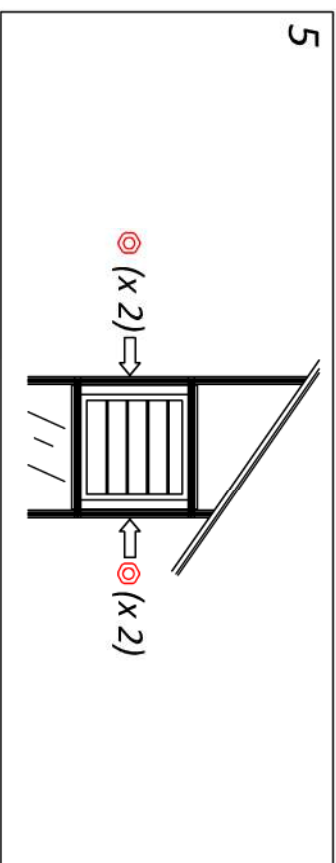
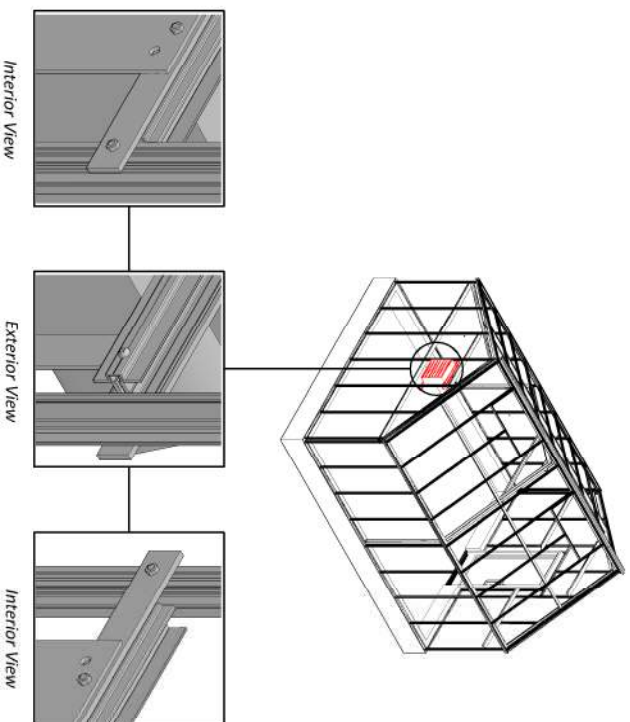

**PRO TIPS**

Depending on the Fan used and the style of Greenhouse, the filler beside the Fan could be Glass, Aluminum or a combination of both. Refer to your job specific drawings to see what material is being used for your Greenhouse.

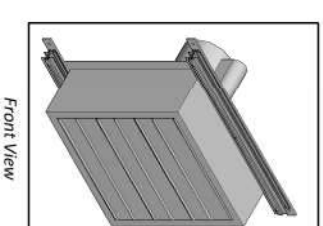

Front View

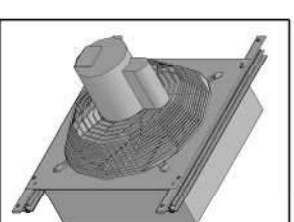

Back View

**Parts List:**



Exhaust Fan



1/4" x 1/2" S.S. Bolts & Nuts



Silicone



Setting Block  
(Double Glass Models)

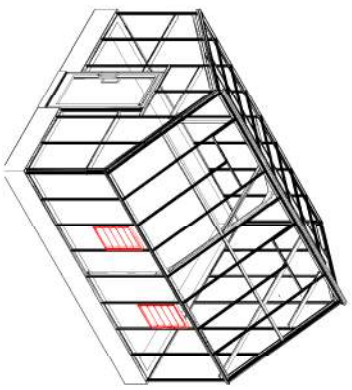

**ACCESSORIES: LOUVRES  
(3MM SINGLE GLASS, 6MM SINGLE GLASS)**

- STEPS:**
1. INSTALL THE APPROPRIATE GLASS PANEL DESIGNATED FOR BELOW THE LOUVRE.
  2. FROM OUTSIDE THE GREENHOUSE, REST THE LOUVRE ON TOP OF THE GLASS PANEL.
  3. INSTALL THE APPROPRIATE GLASS PANEL DESIGNATED FOR ABOVE THE LOUVRE.
  4. SEAL ABOVE AND BELOW THE LOUVRE.

CONTINUE GLAZING AND CAPPING AS NORMAL. (LOUVRE WILL BE HELD IN PLACE WITH THE CAPS).

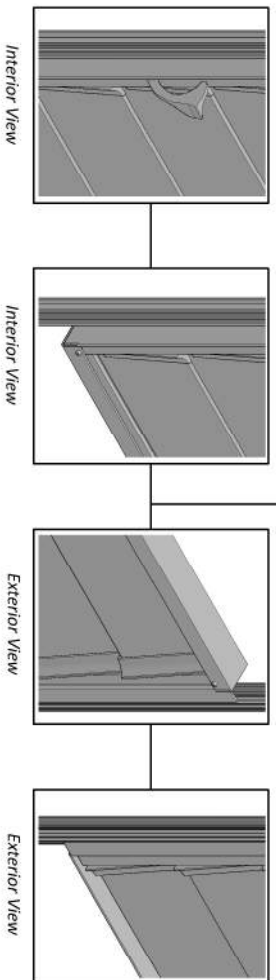
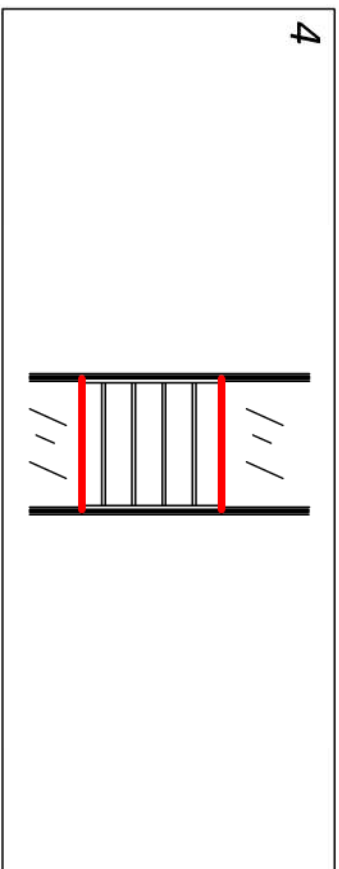
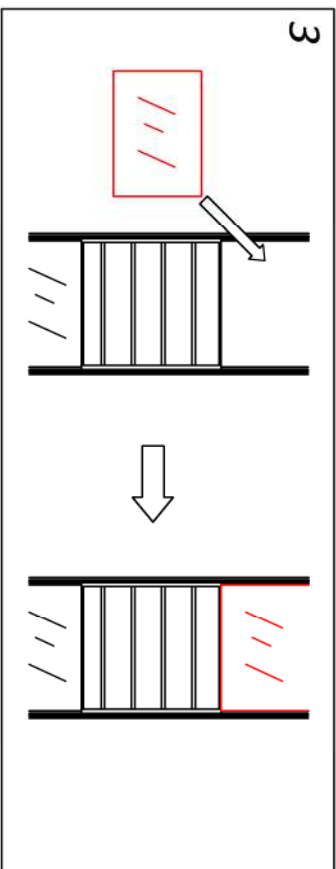
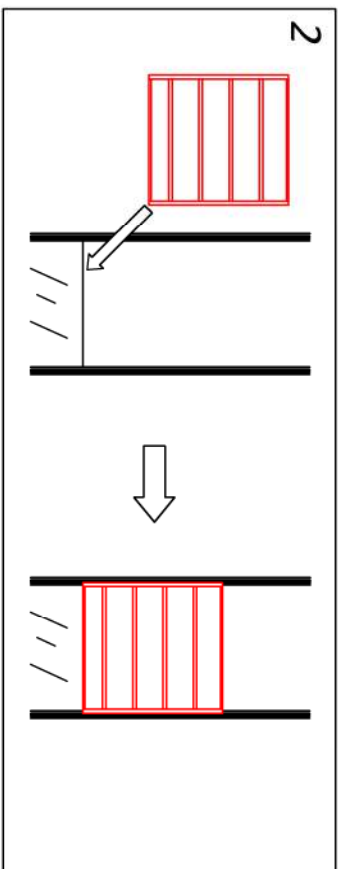
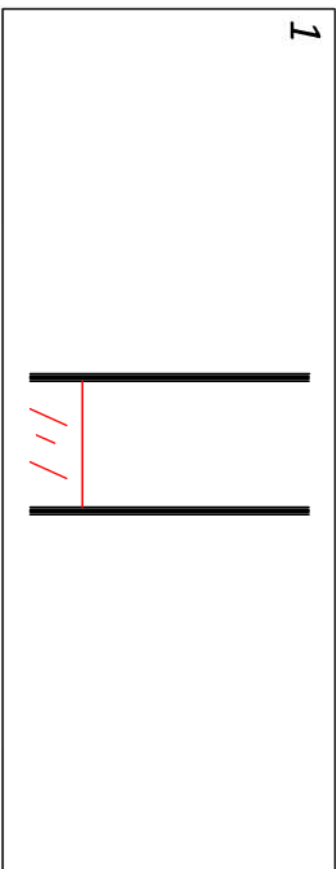

**Parts List:**

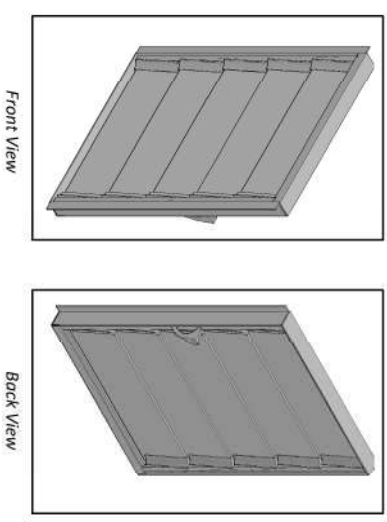
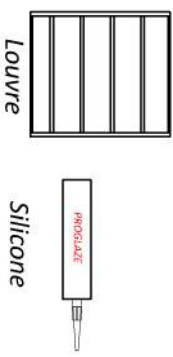

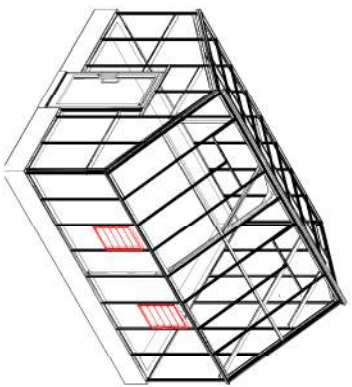

**ACCESSORIES: LOUVRES  
(6MM POLY, 16MM SWALL POLY, 16MM DOUBLE GLASS)**

- STEPS:**
1. INSTALL THE APPROPRIATE GLAZING PANEL DESIGNATED FOR BELOW THE LOUVRE COMPLETE WITH THE CORRECT H-CHANNEL.
  2. FROM OUTSIDE THE GREENHOUSE, REST THE LOUVRE ON TOP OF THE H-CHANNEL.
  3. INSTALL THE APPROPRIATE GLASS PANEL DESIGNATED FOR ABOVE THE LOUVRE COMPLETE WITH THE CORRECT H-CHANNEL.
  4. SEAL ABOVE AND BELOW THE LOUVRE.

CONTINUE GLAZING AND CAPPING AS NORMAL. (LOUVRE WILL BE HELD IN PLACE WITH THE CAPS).

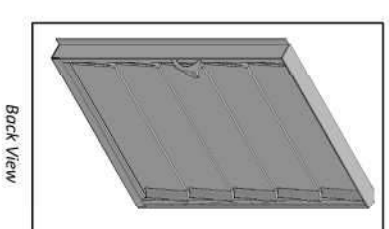
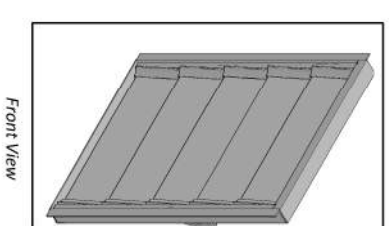
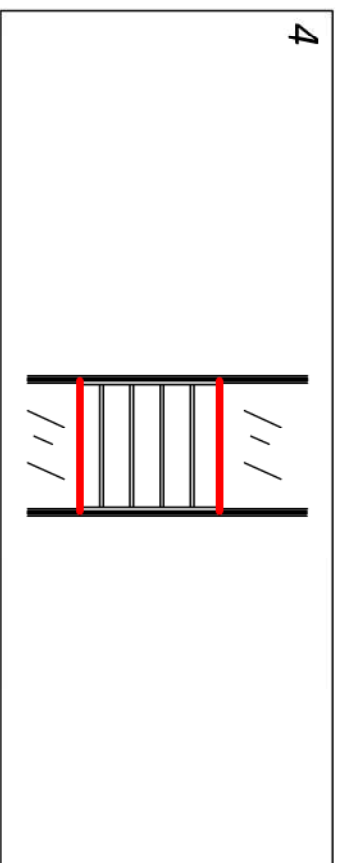
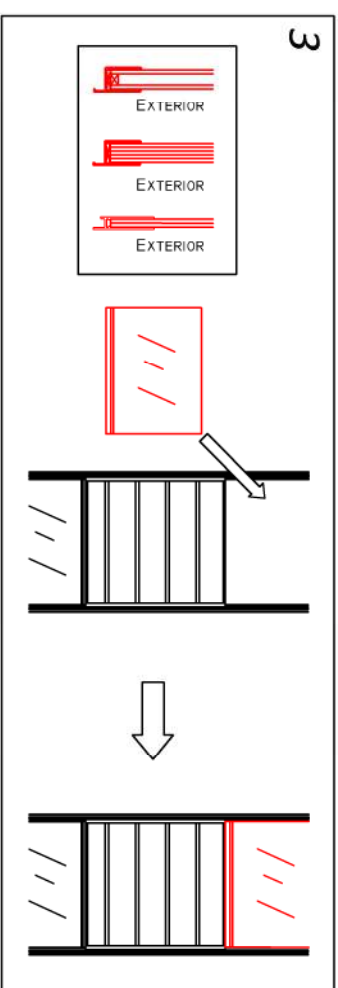
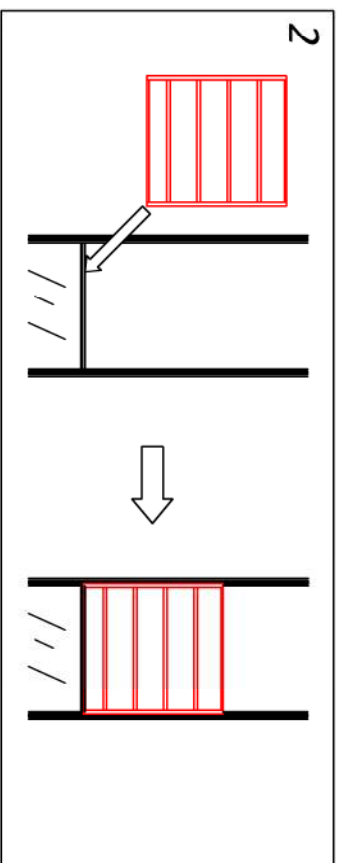
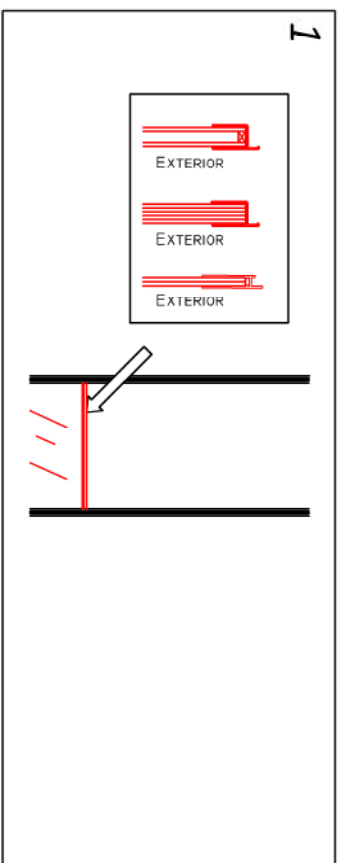
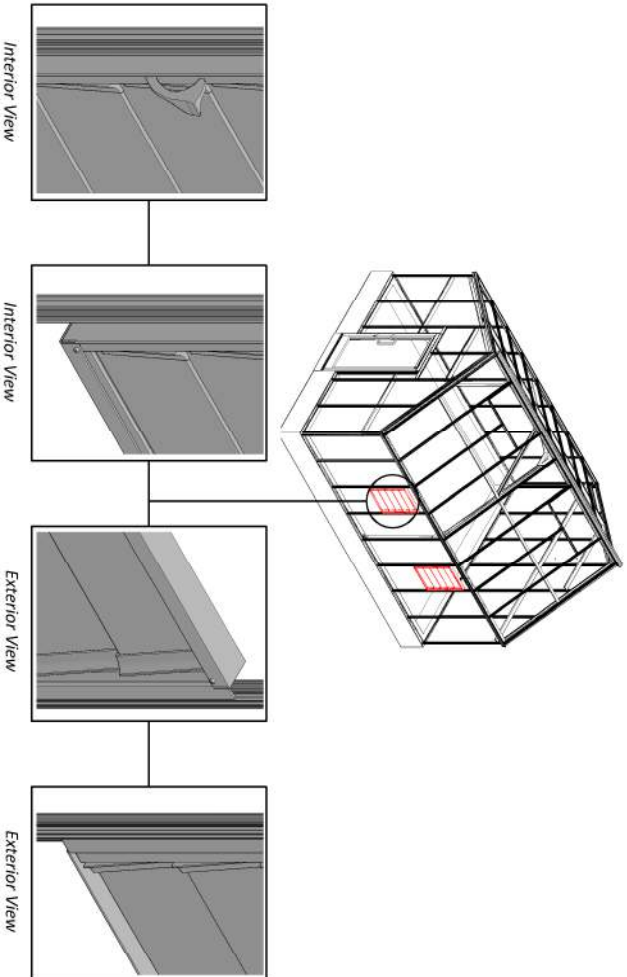

**Parts List:**

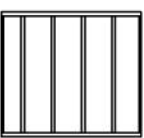

Louvre



Silicone

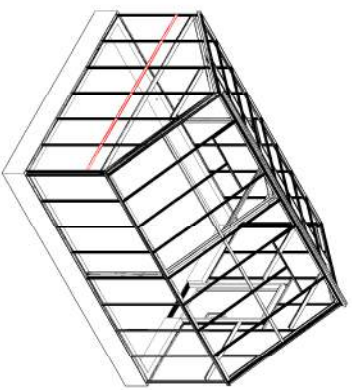

## ACCESSORIES: JOINER BARS (16MM DOUBLE GLASS)

- STEPS:**
1. INSTALL THE APPROPRIATE GLAZING PANEL DESIGNATED FOR BELOW THE JOINER
  2. PLACE (2) SETTING BLOCKS ON TOP OF THE GLASS PANEL.
  3. PEEL THE BLUE TAPE FROM 8, SLIP THE INNER JOINER BEHIND THE GLASS PANEL AND REST IT ON TOP OF THE SETTING BLOCKS.
  - 4 & 5. PLACE (2) SETTING BLOCKS ON TOP OF THE JOINER AND INSTALL THE GLASS PANEL DESIGNATED FOR ABOVE THE JOINER.
  6. FILL THE GAP BETWEEN THE GLASS PANELS WITH SPECTRUM2, LEAVING ENOUGH ROOM FOR THE OUTER JOINER TO BE INSTALLED.
  7. PEEL THE BLUE TAPE FROM 8, INSERT THE OUTER JOINER BETWEEN THE GLASS PANELS.
  8. SECURE THE INNER & OUTER JOINERS TO EACH OTHER WITH (3) #6 X 1/2" SCREWS.
  9. FILL THE INNER JOINER WITH SPECTRUM2.
  10. INSERT THE VINYL SCREW COVER INTO THE INNER JOINER.
  11. SILICONE SEAL THE JOINERS TOP & BOTTOM.
- CONTINUE GLAZING AND CAPPING AS NORMAL.

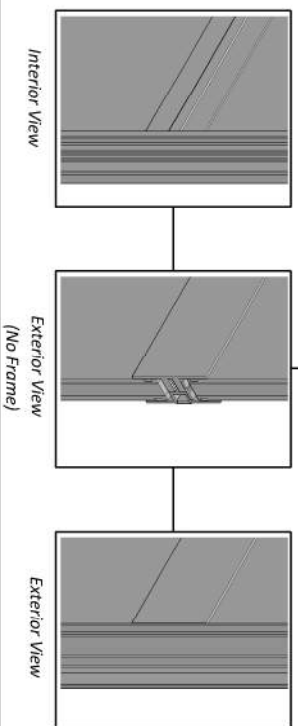

### Parts List:

- Outer Joiner 
- Inner Joiner 
- Screw Cover 
- #6 x 1/2" Screws 
- Silicone 
- Spectrum2 
- Setting Block 

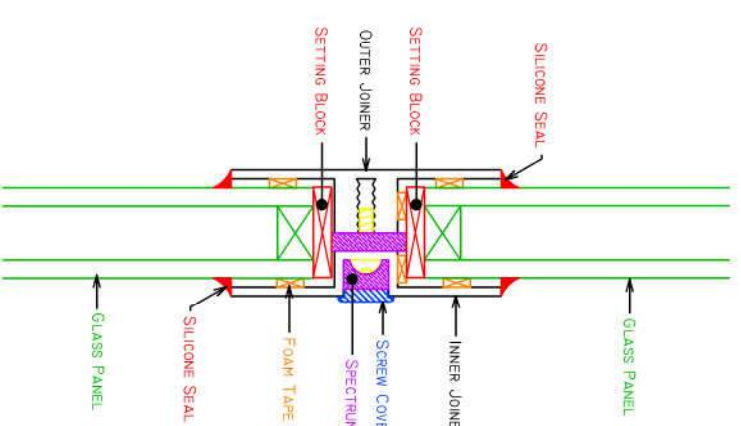
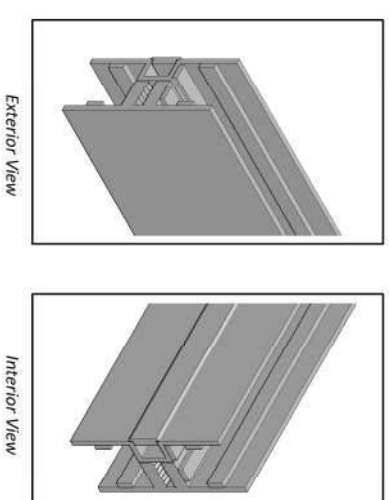
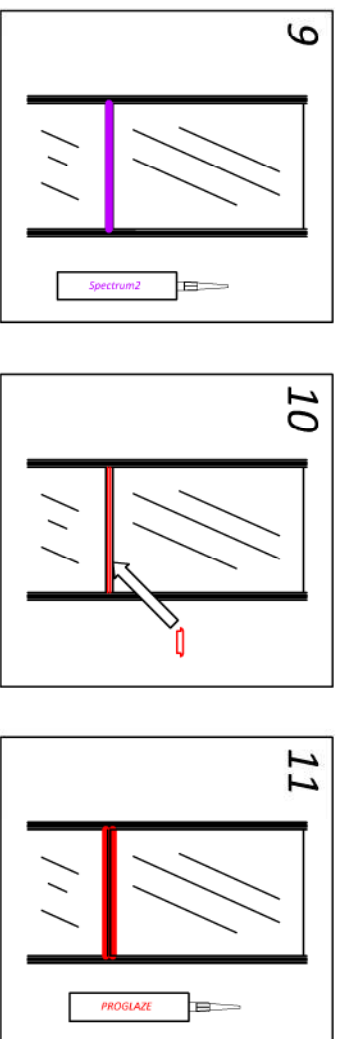
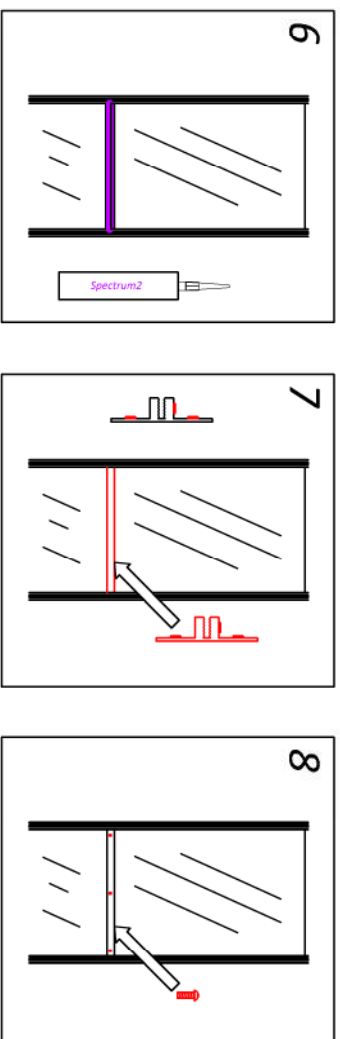
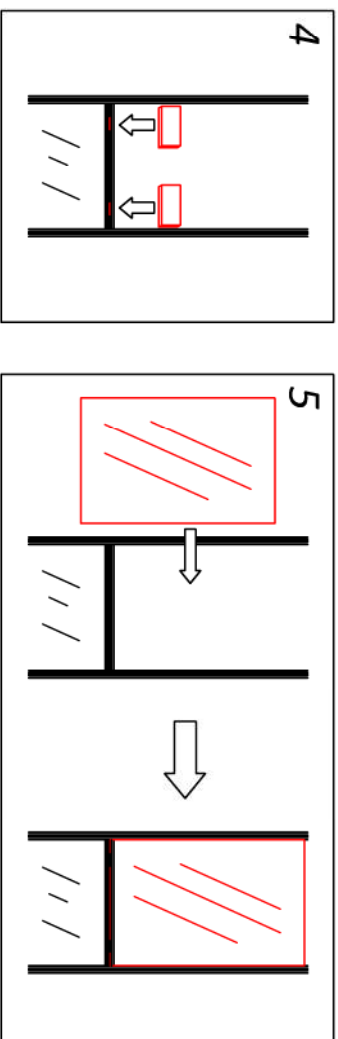
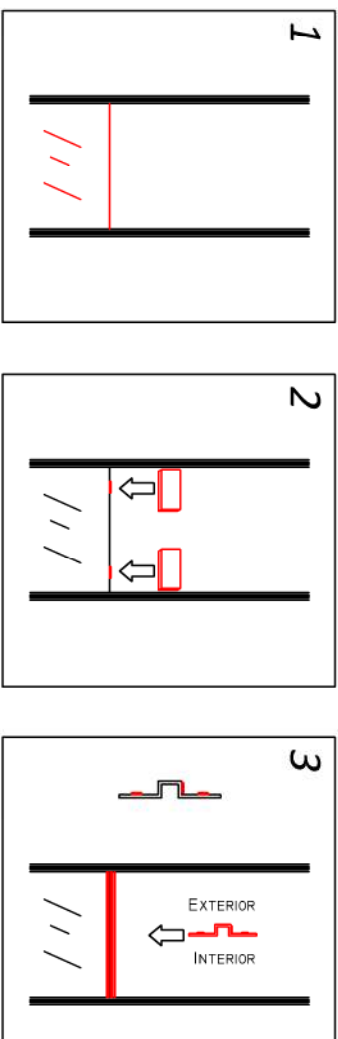

### PRO TIPS

Don't rush when sealing your joiners. Take your time to ensure that the sealants are properly applied and all gaps are filled. Each Joiner should use about 1/2 a tube of Spectrum2

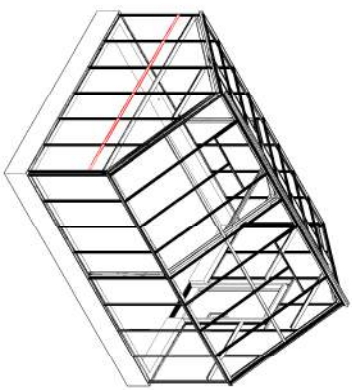

**ACCESSORIES: JOINER BARS  
(6MM SINGLE GLASS)**

- STEPS:**
1. INSTALL THE APPROPRIATE GLAZING PANEL DESIGNATED FOR BELOW THE JOINER
  2. PLACE (2) SETTING BLOCKS ON TOP OF THE GLASS PANEL.
  3. PEEL THE BLUE TAPE FROM 8, SLIP THE INNER JOINER BEHIND THE GLASS PANEL AND REST IT ON TOP OF THE SETTING BLOCKS.
  4. PLACE (2) SETTING BLOCKS ON TOP OF THE JOINER
  5. INSTALL THE GLASS PANEL DESIGNATED FOR ABOVE THE JOINER.
  6. PEEL THE BLUE TAPE FROM 8, INSERT THE OUTER JOINER BETWEEN THE GLASS PANELS.
  7. SILICONE SEAL THE JOINERS TOP & BOTTOM.
- CONTINUE GLAZING AND CAPPING AS NORMAL.

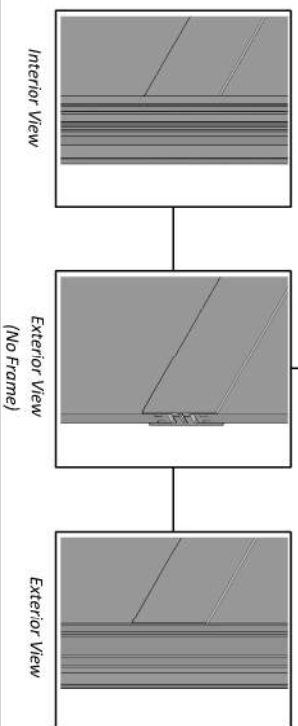

**Parts List:**

- Outer Joiner
- Inner Joiner
- Silicone
- Setting Block

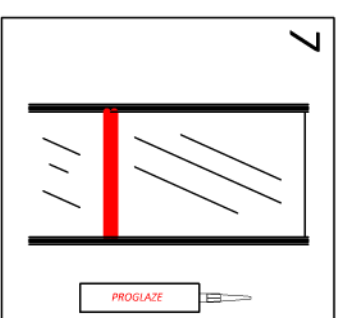
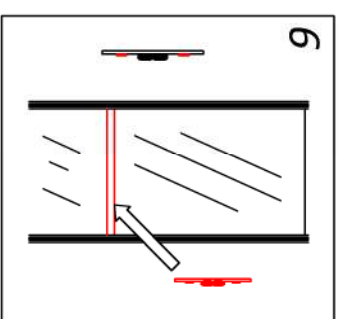
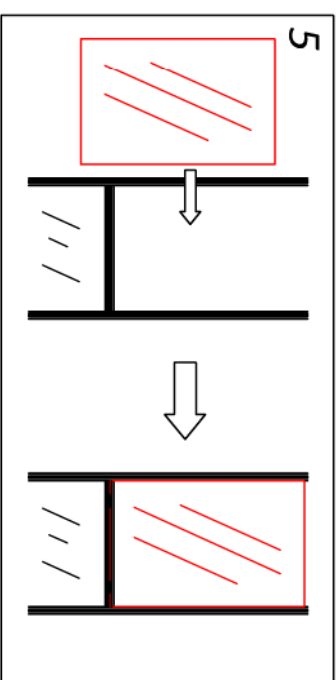
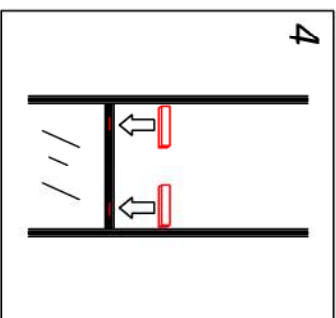
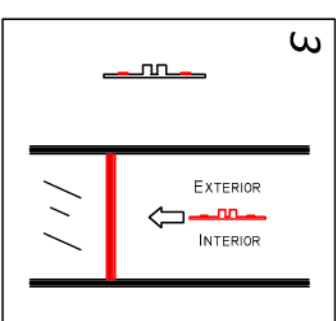
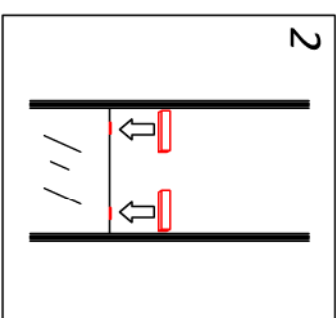
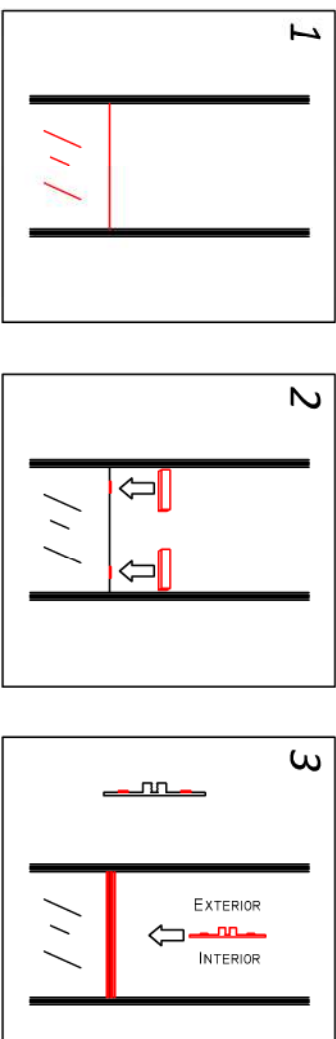

**PRO TIPS**

*Don't rush when sealing your joiners. Take your time to ensure that the sealants are properly applied and all gaps are filled, particularly in the Roof.*

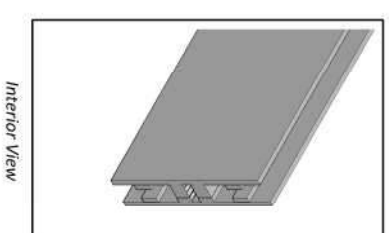
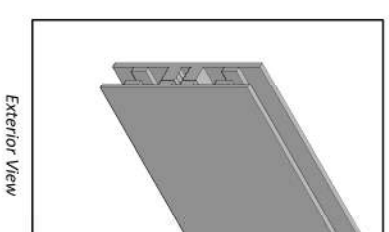
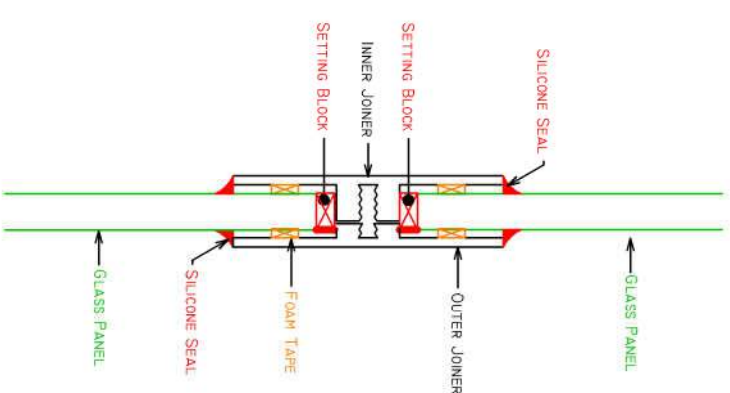

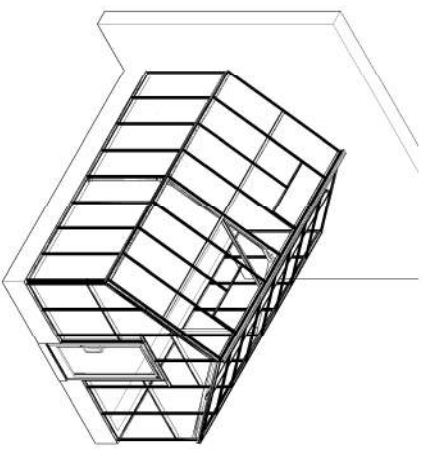

## ACCESSORIES: GABLE ATTACHMENT (ALL GLAZING TYPES - STANDARD CAPS)

### STEPS:

COMPLETE STAGES 1-5 OF THE INSTALLATION MANUAL FOR THE GABLE WALL THAT IS NOT CONNECTING TO THE EXISTING BUILDING.

1. ATTACH THE SIDE WALL OUTER BARS TO THE GREENHOUSE BASE USING  $\frac{1}{2}$ " X  $\frac{1}{2}$ " BOLTS & NUTS.
2. USING A 4' LEVEL, ENSURE THAT THE SIDE WALL OUTER BARS ARE VERTICAL FRONT-TO-BACK AND LEFT-TO-RIGHT.
3. SECURE SIDE WALL OUTER BARS TO TO THE EXISTING BUILDING USING # 8 X 2" SCREWS. REPEAT FOR BOTH SIDES.

COMPLETE STAGE 6 & 7 OF THE INSTALLATION MANUAL.

4. CAULK THE ENDS OF THE GUTTERS, BASE AND SIDE WALL OUTER BAR WHERE THEY BUTT AGAINST THE EXISTING BUILDING.

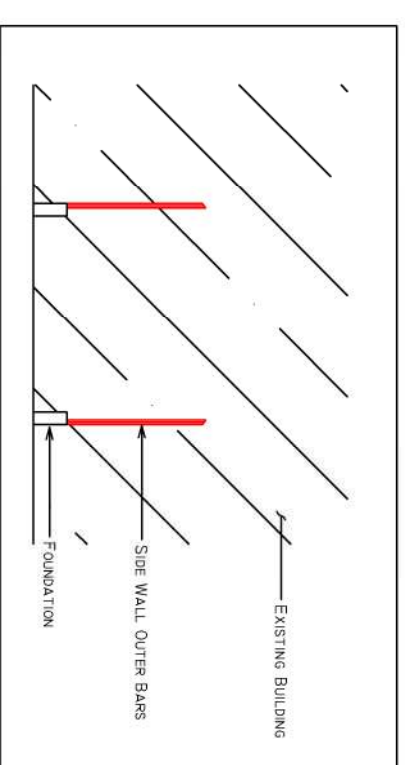
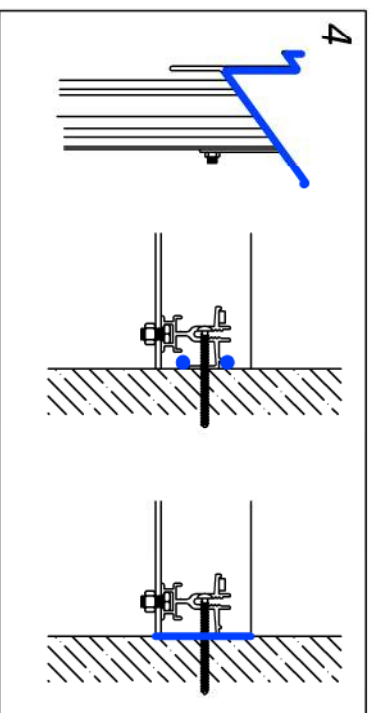
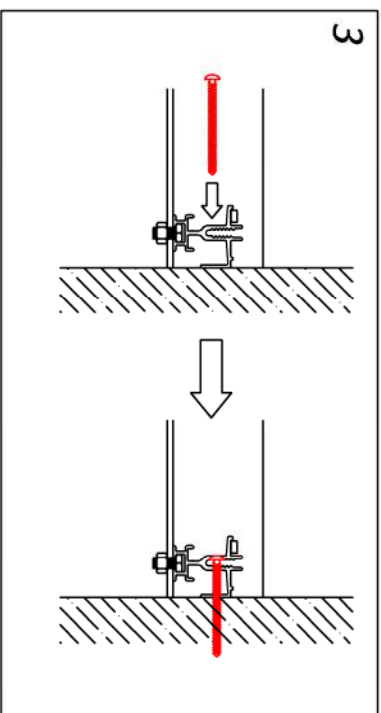
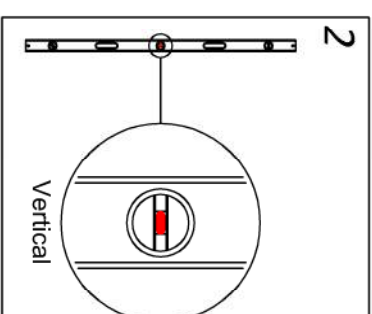
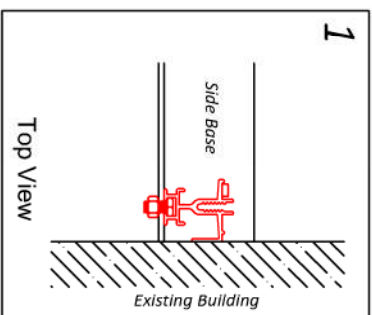
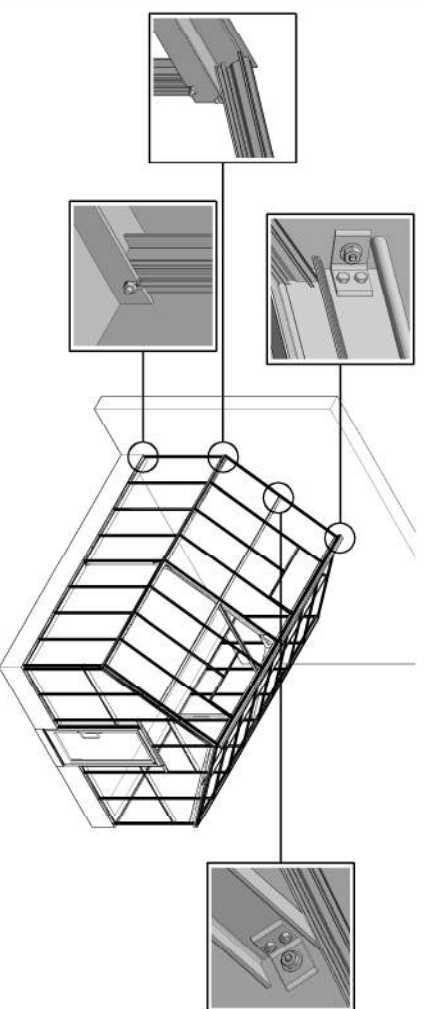











### PRO TIPS



When Gable Attaching a greenhouse, it is more imperative than ever to ensure that your foundation is level and the building you are attaching to is perpendicular to the foundation.

### Parts List:

- |   |   |   |   |   |   |   |   |   |   |
|---|---|---|---|---|---|---|---|---|---|
|  |  |  |  |  |  |  |  |  |  |
| Glazing Outer Bar<br>(3mm Single Glass)   | Glazing Outer Bar<br>(6mm Twinwall Poly.)   | Glazing Outer Bar<br>(6mm Single Glass)   | Glazing Bar<br>(16mm Fivewall Poly.)  | Glazing Outer Bar<br>(16mm Double Glass)  | #8 x 2" S.S. Screw  | $\frac{1}{4}$ " x $\frac{1}{2}$ " S.S. Bolts & Nuts                                 | Concrete Anchor<br>w/ Nut & Washer<br><i>(if applicable)</i>                        | Log Bolt & Washer   | CAULKING<br>TREMCO 830  |



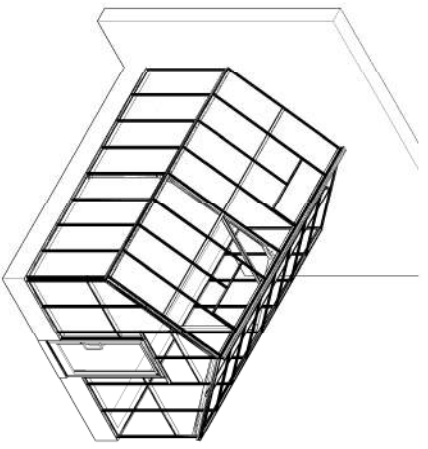

**ACCESSORIES: GABLE ATTACHMENT  
(ALL GLAZING TYPES - STANDARD CAPS)**

**STEPS:**

COMPLETE STAGE 8 OF THE INSTALLATION MANUAL FOR THE GABLE WALL THAT IS NOT CONNECTING TO THE EXISTING BUILDING.

5. BOLT THE ROOF OUTER BARS TO THE GUTTERS USING 1/4" X 1/2" BOLTS & NUTS. ALLOW THE ROOF OUTER BARS TO TOUCH AND SUPPORT EACH OTHER WHERE THEY MEET AT THE PEAK.

COMPLETE STAGE 9 OF THE INSTALLATION MANUAL FOR THE GABLE WALL THAT IS NOT CONNECTING TO THE EXISTING BUILDING.

6. FIT THE RIDGE BEAM BETWEEN THE ROOF OUTER BARS AND SECURE IT WITH 1/2" X 1/2" BOLTS & NUTS.
7. VERIFY THAT THE RIDGE IS LEVEL.
8. SECURE ROOF OUTER BARS TO THE EXISTING BUILDING USING #8 X 2" SCREWS.
9. SECURE RIDGE TO EXISTING BUILDING USING SUPPLIED LAG BOLTS OR ANCHORS.
10. CAULK ROOF OUTER BARS & RIDGE AT EXISTING BUILDING

COMPLETE STAGES 10 & 11 OF THE INSTALLATION MANUAL (IF APPLICABLE)

11. SECURE THE PURLINS (IF APPLICABLE) TO THE EXISTING BUILDING USING SUPPLIED LAG BOLTS OR ANCHORS

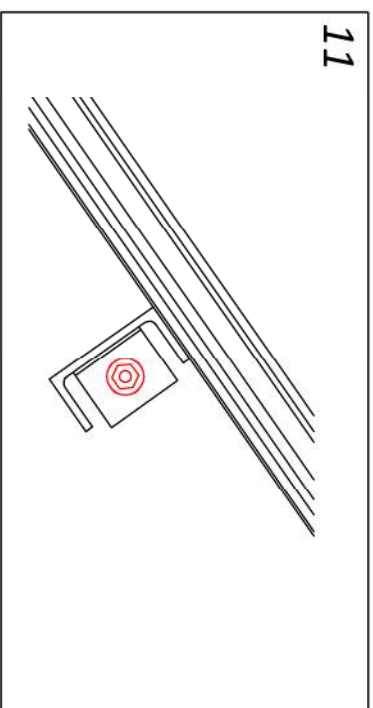
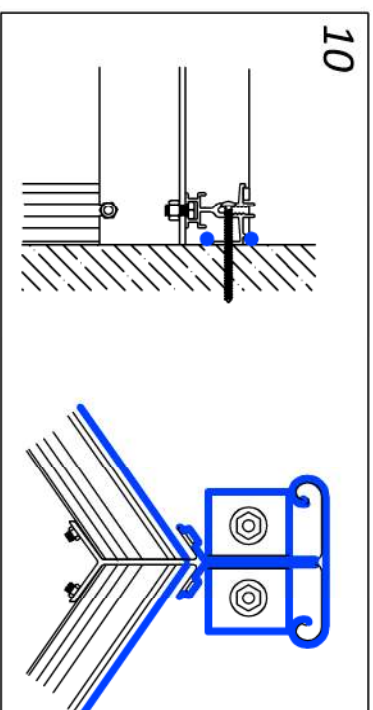
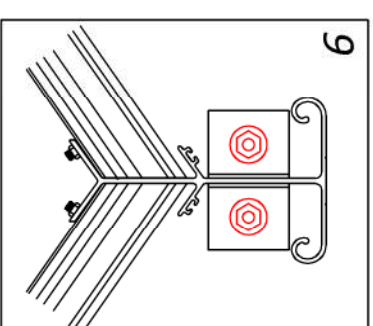
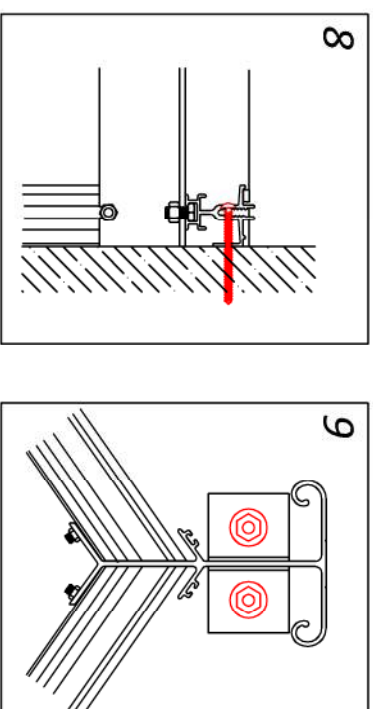
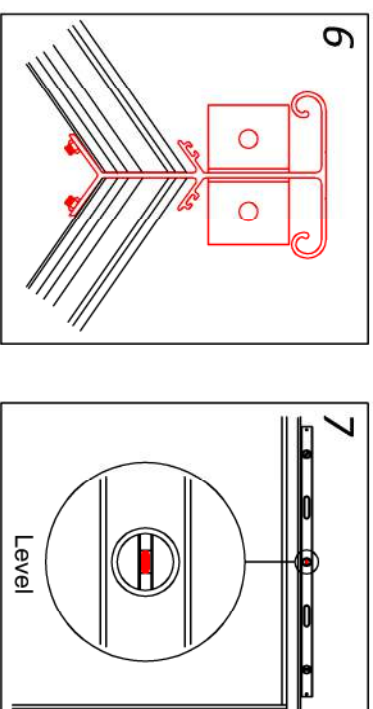
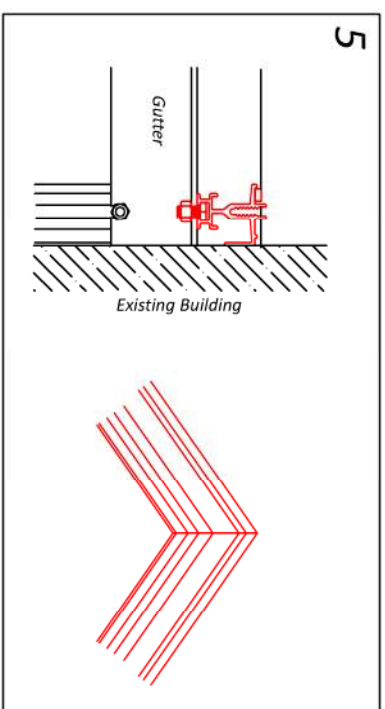
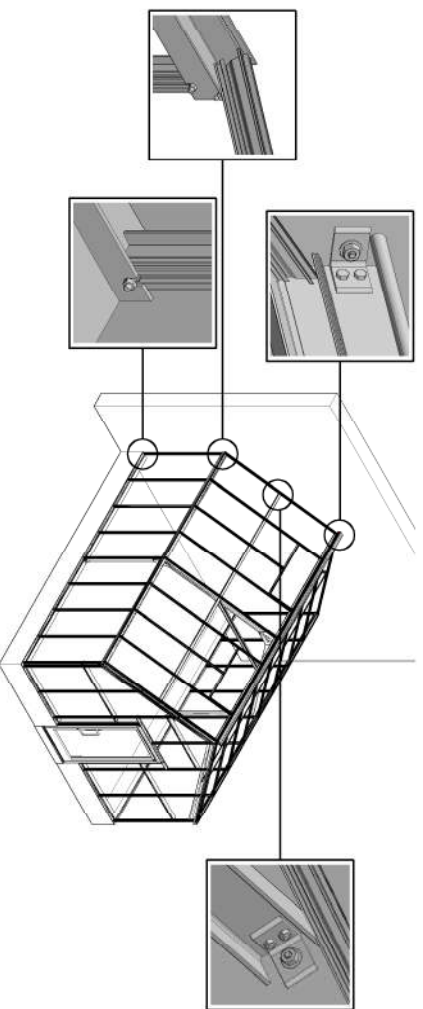

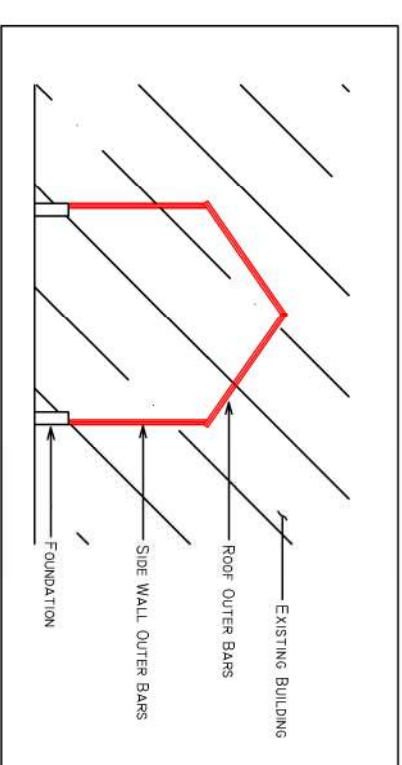

**PRO TIPS**

When Gable Attaching a greenhouse, it is more imperative than ever to ensure that your foundation is level and the building you are attaching to is perpendicular to the foundation.





**Parts List:**

- 

Glazing Outer Bar  
(3mm Single Glass)
- 

Glazing Outer Bar  
(6mm Twinwall Poly.)
- 

Glazing Outer Bar  
(6mm Single Glass)
- 

Glazing Bar  
(16mm Fivewall Poly.)
- 

Glazing Outer Bar  
(16mm Double Glass)
- 

#8 x 2" S.S. Screw
- 

1/4" x 1/2" S.S. Bolts & Nuts
- 

Concrete Anchor  
w/ Nut & Washer  
*(if applicable)*
- 

Lag Bolt & Washer
- 

TREMCO 830  
Caulking

Should you have questions along the way with your greenhouse installation, please call our Technical Support line at 1-800-665-2124 or email [info@greenhousestyle.com](mailto:info@greenhousestyle.com).

Join our Facebook page to share your success and ask gardening related questions. But most of all please tag us on Facebook @greenhousesgalore in photos! It's the best compliment you can give us.

From all of us at Greenhouse Style Corporation, we wish you many years of successful growing!



**Greenhouse Style**  
CORPORATION

Toll Free: 1-800-665-2124

Fax: 1-888-273-1251

[info@greenhousestyle.com](mailto:info@greenhousestyle.com)

[www.greenhousestyle.com](http://www.greenhousestyle.com)

